



Inverter

i510 protec frequency inverter

Contents

1	About this document	13
1.1	Document description	13
1.2	Further documents	13
1.3	Notations and conventions	14
2	Safety instructions	15
2.1	Basic safety instructions	15
2.2	Application as directed	16
2.3	Residual hazards	17
3	Product information	19
3.1	Identification of the products	19
4	Commissioning	20
4.1	Important notes	20
4.2	Initial switch-on and functional test	21
4.3	Operating interfaces	23
4.3.1	Keypad	23
4.3.2	Engineering tool »EASY Starter«	24
4.3.2.1	Generate a connection between inverter and »EASY Starter«	25
4.3.3	SMART Keypad App	27
4.4	General information on parameter setting	28
4.4.1	Addressing of the parameters	28
4.4.2	Structure of the parameter descriptions	29
4.4.3	Parameter overview lists	29
4.4.4	Favorites	30
4.4.4.1	Accessing the "Favorites" with the keypad	30
4.4.4.2	Favorites parameter list (default setting)	31
4.4.4.3	Configuring the "Favorites"	32
4.5	Saving the parameter settings	35
4.5.1	Save parameter settings with keypad	35
4.5.2	Save parameter settings with »EASY Starter«	35
4.5.3	Saving the settings	35
5	Basic setting	36
5.1	Device name	36
5.2	Mains voltage	36
5.3	Dual rating	37
5.4	Frequency limits	38
5.5	Start behavior	39
5.6	Stop behavior	42
5.7	Function assignment of the inputs and outputs (default setting)	44
5.8	Motor data	45
5.8.1	Select motor from motor catalog	46
5.8.2	Manual setting of the motor data	47
5.9	Motor control mode	48

Contents

6	Start, stop and rotating direction commands	49
6.1	Control selection.....	49
6.1.1	Flexible I/O configuration	51
6.1.2	Keypad control	52
6.1.3	Keypad full control.....	53
6.2	Flexible I/O configuration of the start, stop and rotating direction commands.....	54
6.2.1	Trigger list.....	59
6.2.2	Example: Start/stop (1 signal) and reversal.....	62
6.2.3	Example: Start forward/start reverse/stop (edge-controlled).....	63
6.2.4	Example: Run forward/Run reverse/stop (status-controlled).....	65
6.2.5	Example: Quick stop	67
6.2.6	Example: Enable inverter.....	68
6.2.7	Example: Jog forward/Jog reverse.....	69
6.3	Control/restrict direction of rotation of the motor.....	71
6.4	Changing the control source during operation	72
6.4.1	Example: Change-over from terminal control to keypad control	75
6.4.2	Example: Change-over from terminal control to network control	77
7	Configuring the frequency control	78
7.1	Basic setting.....	78
7.1.1	Standard setpoint source.....	78
7.1.2	Ramp times	80
7.2	Configure setpoint sources.....	82
7.2.1	Keypad	82
7.2.2	Setpoint presets	83
7.2.3	Motor potentiometer (MOP).....	85
7.2.4	Sequencer	87
7.2.4.1	Segment configuration.....	89
7.2.4.2	Sequence configuration	99
7.2.4.3	Sequencer basic settings.....	103
7.2.4.4	Sequencer control functions.....	106
7.2.4.5	Sequencer diagnostics	110
7.3	Configuring the process controller	112
7.3.1	Basic setting	113
7.3.2	Process controller sleep mode.....	119
7.3.3	Process controller rinse function	121
7.3.4	Process controller function selection.....	121
7.3.5	Process controller diagnostics.....	123
7.4	Changing the setpoint source during operation.....	125
7.4.1	Example: Change-over from keypad setpoint to AI1/AI2 setpoint	129
7.4.2	Example: Change-over from AI1 setpoint to keypad setpoint.....	131
7.4.3	Example: Change-over from keypad setpoint to preset 1 ... 7	133
7.4.4	Example: Change-over from AI1 setpoint to MOP setpoint.....	136
7.5	Change over to ramp 2 during operation.....	138
7.6	"Switch-off positioning" stop mode.....	141
7.7	Setpoint diagnostics.....	145

8	Configuring the torque control	146
8.1	Basic setting	147
8.1.1	Standard setpoint source	148
8.1.2	Torque limits	150
8.1.3	Speed limitation	152
8.1.4	Ramp time	154
8.2	Configure setpoint sources	155
8.2.1	Keypad	155
8.2.2	Setpoint presets	156
8.2.3	Motor potentiometer (MOP)	156
8.3	Process input data (CiA 402 objects)	157
8.4	Process output data (CiA 402 objects)	157
8.5	Setpoint diagnostics	158
9	Configuring the feedback system	159
9.1	Synchronous motor: Pole position identification (PPI)	159
9.1.1	Monitoring the pole position identification	159
9.1.2	Pole position identification (PPI) without movement	159

Contents

10	Configuring the motor control	160
10.1	Sensorless control for synchronous motor (SL-PSM)	162
10.1.1	Required commissioning steps	163
10.1.2	Stalling protection	163
10.1.3	Expert settings	164
10.2	Sensorless vector control (SLVC)	165
10.2.1	Required commissioning steps	165
10.2.2	Expert settings	166
10.3	V/f characteristic control for asynchronous motor (VFC open loop)	167
10.3.1	Required commissioning steps	167
10.3.2	Basic setting	167
10.3.3	Define V/f characteristic shape	168
10.3.3.1	Linear V/f characteristic	169
10.3.3.2	Square-law V/f characteristic	170
10.3.3.3	Multipoint V/f characteristic	171
10.3.3.4	Energy-saving V/f characteristic (VFC-Eco)	172
10.3.3.5	User-definable V/f characteristic	173
10.3.4	Set voltage boost	175
10.3.5	Set slip compensation	176
10.3.6	Set oscillation damping	178
10.3.7	Optimising the stalling behaviour	179
10.3.8	Torque limitation setting	181
10.3.9	Flying restart circuit	182
10.3.10	Additive voltage impression	183
10.4	Sensorless control for synchronous motor (SLSM-PSM)	185
10.4.1	Required commissioning steps	186
10.4.2	Expert settings	187
10.5	Parameterisable motor functions	188
10.5.1	Skip frequencies	188
10.5.2	DC braking	190
10.5.2.1	Example: Automatic DC braking when starting the motor	191
10.5.2.2	Example: Automatic DC braking when stopping the motor	192
10.5.2.3	Activating DC braking manually	194
10.5.2.4	Migration of Lenze Inverter Drives 8200/8400	196
10.5.3	Holding brake control	197
10.5.3.1	Basic setting	198
10.5.3.2	"Automatic" brake mode (automatic operation)	199
10.5.3.3	Brake holding load	200
10.5.3.4	Brake closing threshold	202
10.5.3.5	Manual release of the holding brake	204
10.5.4	Load loss detection	206

10.6	Options for optimizing the control loops.....	207
10.6.1	Automatic motor identification (energized).....	210
10.6.2	Automatic motor calibration (non-energized).....	211
10.6.3	Tuning of the motor and the speed controller.....	212
10.6.4	Inverter characteristic.....	214
10.6.5	Motor equivalent circuit diagram data.....	214
10.6.6	Motor control settings.....	216
10.6.6.1	Speed controller.....	217
10.6.6.2	Current controller.....	218
10.6.6.3	Current controller (field-oriented control).....	219
10.6.6.4	ASM field controller.....	219
10.6.6.5	ASM field weakening controller.....	220
10.6.6.6	ASM field weakening controller (extended).....	220
10.6.6.7	PSM field weakening controller.....	220
10.6.6.8	I _{max} controller.....	221
10.6.6.9	Flying restart controller.....	222
10.6.6.10	SLVC controller.....	222
10.6.6.11	General optimizations.....	222
10.7	Motor protection.....	223
10.7.1	Motor overload monitoring (i ² xt).....	224
10.7.2	Overcurrent monitoring.....	228
10.7.3	Motor phase failure detection.....	229
10.7.4	Motor speed monitoring.....	230
10.7.5	Motor torque monitoring.....	231
10.7.6	Maximum overload current of the inverter.....	233
10.7.7	Heavy load monitoring.....	235
11	I/O extensions and control connections.....	237
11.1	Configure digital inputs.....	237
11.2	Configure analog inputs.....	240
11.2.1	Analog input 1.....	240
11.2.1.1	Example: Input range 0 ... 10 V = setting range 0 ... 50 Hz.....	242
11.2.1.2	Example: Input range 0 ... 10 V = setting range -40 ... +40 Hz.....	243
11.2.1.3	Example: Error detection.....	243
11.2.2	Analog input 2.....	244
11.3	Configure digital outputs.....	247
11.3.1	Relay output.....	247
11.3.2	Digital output 1.....	251
11.4	Configure analog outputs.....	253
11.4.1	Analog output 1.....	253
11.4.1.1	Example: Output voltage 0 ... 10 V = output frequency 0 ... 100 Hz.....	255
11.4.1.2	Example: Output voltage 2 ... 10 V = output frequency 30 ... 60 Hz.....	255
11.4.1.3	Example: mirrored output range.....	256

Contents

12 Configuring the network	257
12.1 Control the inverter via network	258
12.1.1 Activate network control	258
12.1.2 Predefined control and status words	259
12.1.3 Define your own control word format	261
12.1.4 Define your own status word format	269
12.2 Define setpoint via network	273
12.2.1 Option 1: Define network as standard setpoint source	274
12.2.2 Option 2: Change over to the network setpoint during operation	275
12.2.3 Mappable parameters for exchanging setpoints and actual values	276
12.3 Further mappable parameters	278
12.3.1 Process input data	279
12.3.1.1 Feedback of PID variable via network	279
12.3.1.2 Control digital outputs via network	279
12.3.1.3 Control analog outputs via network	279
12.3.1.4 Additive voltage impression via network	280
12.3.2 Process output data	281
12.3.2.1 Drive status	281
12.3.2.2 Output messages of the "sequencer" function via network	281
12.4 Parameter access monitoring (PAM)	282
12.5 Process data handling in the event of error	283
12.6 Suppress certain alarm / emergency messages to the master	284
12.7 CiA 402 device profile	285
12.7.1 Supported operating modes	285
12.7.2 Basic setting	286
12.7.3 Process input data	287
12.7.4 Process output data	287
12.7.5 Commands for device state control	288
12.7.5.1 Switch-off	289
12.7.5.2 Switch on	290
12.7.5.3 Enable operation	291
12.7.5.4 Activate quick stop	292
12.7.5.5 Disable operation	293
12.7.5.6 Pulse inhibit	294
12.7.5.7 Reset fault	295
12.7.6 Device states	296
12.7.6.1 Not ready to switch on	297
12.7.6.2 Switch-on inhibited	298
12.7.6.3 Ready to switch on	299
12.7.6.4 Switched on	300
12.7.6.5 Operation enabled	301
12.7.6.6 Quick stop active	302
12.7.6.7 Fault reaction active	303
12.7.6.8 Trouble	304
12.8 AC drive	305
12.8.1 AC drive control word	305
12.8.2 AC drive status word	306
12.8.3 AC motor type	306
12.9 Lenze LECOM profile	307

12.10	CANopen	308
12.10.1	Commissioning	309
12.10.2	Basic setting and options	313
12.10.2.1	Node address setting	313
12.10.2.2	Baud rate setting	313
12.10.2.3	Configuring the device as mini master	313
12.10.3	Process data transfer	315
12.10.3.1	Data mapping	320
12.10.4	Parameter data transfer	323
12.10.5	Monitoring	325
12.10.5.1	Emergency telegram	325
12.10.5.2	Heartbeat protocol	325
12.10.5.3	Error responses	326
12.10.6	Diagnostics	328
12.10.6.1	LED status display	328
12.10.6.2	Information on the network	328
12.10.6.3	Device identification	330
12.11	Modbus RTU	332
12.11.1	Commissioning	333
12.11.2	Basic setting and options	335
12.11.2.1	Node address setting	335
12.11.2.2	Baud rate setting	335
12.11.2.3	Data format setting	335
12.11.2.4	Minimum response time setting	335
12.11.3	Data transfer	336
12.11.3.1	Function codes	337
12.11.3.2	Data mapping	339
12.11.4	Monitoring	340
12.11.5	Diagnostics	341
12.11.5.1	LED status display	341
12.11.5.2	Information on the network	341
13	Device functions	345
13.1	Optical device identification	345
13.2	Reset parameters to default	346
13.2.1	Configure reset behaviour	347
13.3	Saving/loading the parameter settings	348
13.4	Access protection	351
13.4.1	Write access protection	351
13.4.1.1	Write access protection in the »EASY Starter«	353
13.4.1.2	Write access protection in the keypad	356
13.5	Switching frequency changeover	359
13.6	Device overload monitoring (ixt)	360
13.7	Heatsink temperature monitoring	360
13.8	Automatic restart after a fault	361
13.9	User-defined error triggering	362
13.10	Update device firmware	363
13.10.1	Firmware download with »EASY Starter (firmware loader)«	363
13.11	Behaviour of the inverter in case of incompatible data in the memory module	364

Contents

14 Additional functions	367
14.1 Brake energy management	367
14.1.1 Stopping the deceleration ramp function generator	368
14.1.2 Inverter motor brake	369
14.2 Parameter change-over.....	370
14.2.1 Example: Selective control of several motors with one inverter	371
14.2.1.1	371
14.2.2 Parameter set configuration	372
14.2.3 Device commands for parameter change-over.....	373
14.2.4 Functions for parameter change-over.....	375
14.2.4.1 Example: Activation via command (only when disabled).....	377
14.2.4.2 Example: Activation via command (immediately).....	378
14.2.4.3 Example: Activation if the selection is changed (only if the inverter is disabled)...	379
14.2.4.4 Example: Activation if the selection is changed (immediately)	380
14.3 Trigger action if a frequency threshold is exceeded.....	381
14.4 Position counter.....	383
14.5 Mains failure control.....	386
14.5.1 Activating the mains failure control	388
14.5.2 Restart protection.....	389
14.5.3 Fast mains recovery	389
14.5.4 Commissioning the mains failure control.....	390
14.6 Operation with UPS.....	391
14.7 Cascade function for pumps and fans.....	394

15 Using accessories	399
15.1 Keypad.....	399
15.1.1 Keypad operating mode.....	400
15.1.1.1 Keypad status display.....	400
15.1.1.2 Function of keypad keys in operating mode	401
15.1.1.3 Error reset with keypad.....	402
15.1.2 Keypad parameterisation mode.....	403
15.1.2.1 Parameter groups	403
15.1.2.2 Function of the keypad keys in the parameterisation mode	404
15.1.2.3 Save parameter settings with keypad.....	405
15.1.2.4 Display of status words on keypad	406
15.1.2.5 Keypad parameter list.....	407
15.1.3 Keypad settings	425
15.1.3.1 Select language.....	425
15.1.3.2 Change setpoint increment.....	425
15.1.3.3 Configure status display.....	425
15.1.3.4 Configure R/F and CTRL keys.....	426
15.2 WLAN module.....	428
15.2.1 WLAN LED status displays.....	428
15.2.2 WLAN basic settings	429
15.2.2.1 Resetting WLAN settings to default setting.....	431
15.2.3 WLAN access point mode	432
15.2.3.1 Establish a WLAN connection between smartphone and inverter	433
15.2.3.2 Using the smartphone as "Smart Keypad".....	434
15.2.3.3 Establish a WLAN connection between Engineering PC and inverter.....	435
15.2.4 WLAN client mode.....	437
15.2.5 WLAN diagnostics.....	438
16 Diagnostics and fault elimination	439
16.1 LED status display	439
16.2 Logbook.....	439
16.3 Error history buffer	440
16.3.1 Read out error history buffer	443
16.4 Diagnostic parameters.....	444
16.4.1 Inverter diagnostics	445
16.4.2 Network diagnostics.....	449
16.4.3 I/O diagnostics.....	450
16.4.3.1 Digital inputs and outputs.....	450
16.4.3.2 Analog inputs and outputs.....	451
16.4.4 Service life diagnostics.....	453
16.4.5 Device identification.....	453
16.5 Error handling.....	455
16.5.1 Error types.....	456
16.5.1.1 Timeout for error response.....	457
16.5.2 Error configuration	458
16.5.3 Error reset.....	458
16.6 Error codes, causes and remedies.....	461
17 Technical data	479

Contents

18 Appendix	480
18.1 Parameter attribute list.....	480
18.2 Glossary.....	515



1 About this document

WARNING!

Read this documentation carefully before starting any work.

- ▶ Please observe the safety instructions!

1.1 Document description

This documentation is valid up to firmware version:

Firmware version	Software data version	Date
06.02.00.00	V0006	2020-09-14

1.2 Further documents

For certain tasks, information is available in additional documents.

Document	Contents/topics
Configuration document	Basic information on configuring and ordering the product
Mounting and switch-on instructions	Basic information on mounting and initial switch-on of the product <ul style="list-style-type: none">• Is supplied with each component.

More information

For certain tasks, information is available in other media.

Medium	Contents/topics
Engineering Tools	For commissioning
AKB articles	Additional technical information for users in the Application Knowledge Base
CAD data	Download in different formats from the EASY Product Finder
EPLAN macros	Project planning, documentation and management of projects for EPLAN P8.
Device descriptions	Standardized files for network configuration



Information and tools with regard to the Lenze products can be found on the Internet:

www.Lenze.com → Downloads





About this document

Notations and conventions



1.3 Notations and conventions

Conventions are used in this document to distinguish between different types of information.

Numeric notation		
Decimal separator	Point	Generally shown as a decimal point. Example: 1 234.56
Warnings		
UL Warnings	UL	Are used in English and French.
UR warnings	UR	
Text		
Engineering Tools	" "	Software Example: "Engineer", "EASY Starter"
Icons		
Page reference		Reference to another page with additional information. Example:  16 = see page 16
Documentation reference		Reference to other documentation with additional information. Example:  EDKxxx = see documentation EDKxxx

Layout of the safety instructions

DANGER!

Indicates an extremely hazardous situation. Failure to comply with this instruction will result in severe irreparable injury and even death.

WARNING!

Indicates an extremely hazardous situation. Failure to comply with this instruction may result in severe irreparable injury and even death.

CAUTION!

Indicates a hazardous situation. Failure to comply with this instruction may result in slight to medium injury.

NOTICE

Indicates a material hazard. Failure to comply with this instruction may result in material damage.



2 Safety instructions

Disregarding the following basic safety measures and safety information may lead to severe personal injury and damage to property!

Observe all specifications of the corresponding documentation supplied. This is the precondition for safe and trouble-free operation and for obtaining the product features specified.

Please observe the specific safety information in the other sections!

2.1 Basic safety instructions

DANGER!

Dangerous electrical voltage

Possible consequences: Death or severe injuries from electric shock

- ▶ Any work on the device must only be carried out in a deenergized state.
- ▶ After switching off the mains voltage, observe the signs on the product.

Product

- The product must only be used as directed.
- Never commission the product in the event of visible damage.
- The product must never be technically modified.
- Never commission the product before assembly has been completed.
- The product must never be operated without required covers.
- Connect/disconnect all pluggable terminals only in de-energized condition.
- Only remove the product from the installation in the de-energized state.

Personnel

Only qualified and skilled personnel are allowed to work with the product. IEC 60364 and/or CENELEC HD 384 define the qualifications of these persons as follows:

- They are familiar with the installation, mounting, commissioning, and operation of the product.
- They possess the appropriate qualifications for their tasks.
- They are familiar with all regulations for the prevention of accidents, directives, and laws applicable at the location and are able to apply them.

Process engineering

The procedural notes and circuit details described are only proposals. It is up to the user to check whether they can be adapted to the particular applications. Lenze does not take any responsibility for the suitability of the procedures and circuit proposals described.

Device protection

- The maximum test voltage for insulation tests between a control potential of 24 V and PE must not exceed 110 V DC (EN 61800-5-1).

Safety instructions

Application as directed



2.2 Application as directed

- The product serves to control three-phase AC motors and servo motors.
- The product must only be actuated with motors that are suitable for the operation with inverters.
- The product is not a household appliance, but is only designed as a component for commercial or professional use in terms of EN 61000-3-2.
- Depending on the degree of protection, the product can be mounted inside and outside control cabinets.
- The product must only be actuated under the operating conditions and power limits specified in this documentation.
- The product meets the protection requirements of 2014/35/EU: Low-Voltage Directive.
- The product is not a machine in terms of 2006/42/EU: Machinery Directive.
- Commissioning or starting the operation as directed of a machine with the product is not permitted until it has been ensured that the machine meets the regulations of the EC Directive 2006/42/EU: Machinery Directive; observe EN 60204-1.
- Commissioning or starting operation as directed is only permissible if the EMC Directive 2014/30/EU is complied with.
- In residential areas, the product may cause EMC interferences. The operator is responsible for taking interference suppression measures.



2.3 Residual hazards

Even if notes given are taken into consideration and protective measures are implemented, the occurrence of residual risks cannot be fully prevented.

The user must take the residual hazards mentioned into consideration in the risk assessment for his/her machine/system.

If the above is disregarded, this can lead to severe injuries to persons and damage to property!

DANGER!

Danger to life due to electrical voltage!

The product's power connections can still be carrying voltage when the mains supply has been switched off.

Possible consequences: Death, severe injury, or burns

- ▶ Do not touch the power connections immediately.
- ▶ Take note of the corresponding warning plates on the product.
- ▶ Check power terminals for isolation from supply.

Product

Observe the warning labels on the product!



Dangerous electrical voltage:

Before working on the product, make sure there is no voltage applied to the power terminals! After mains disconnection, the power terminals will still carry the hazardous electrical voltage for the time given next to the symbol!



Electrostatic sensitive devices:

Before working on the product, the staff must ensure to be free of electrostatic charge!



High leakage current:

Carry out fixed installation and PE connection in compliance with: EN 61800-5-1 / EN 60204-1



Hot surface:

Use personal protective equipment or wait until the device has cooled down!

Degree of protection - protection of persons and device protection

- Information applies to the mounted and ready-for-use state.

Motor protection

With some settings of the inverter, the connected motor can be overheated.

- E. g. by longer operation of self-ventilated motors at low speed.
- E. g. by longer operation of DC-injection braking.

Protection of the machine/system

Drives can reach dangerous overspeeds.

- E. g. by setting high output frequencies in connection with motors and machines not suitable for this purpose.
- The inverters do not provide protection against such operating conditions. For this purpose, use additional components.

Switch contactors in the motor cable only if the controller is inhibited.

- Switching while the inverter is enabled is only permissible if no monitoring functions are activated.

Safety instructions

Residual hazards



Motor

If there is a short circuit of two power transistors, a residual movement of up to 180° /number of pole pairs can occur at the motor! (e. g. 4-pole motor: residual movement max. $180^\circ/2 = 90^\circ$).



3 Product information

3.1 Identification of the products

In tables, the first 9 digits of the corresponding product code are used to identify the products:

Product code

		I	5	1	A	P	□□□	□	□	□	□	□	□	□	□□□
Product type	Inverter	I													
Product family	i500		5												
Product	i510			1											
Product generation	Generation 1				A										
Mounting type	Wall mounting					P									
Rated power [kW] (Examples)	0.25 kW														137
	0.55 kW														155
	2.2 kW														222
Mains voltage and connection type	1/N/PE AC 120 V														A
	1/N/PE AC 230/240 V														B
	3/PE AC 230/240 V														C
	1/N/PE AC 230/240 V														D
	3/PE AC 230/240 V														D
	3/PE AC 400 V														F
3/PE AC 480 V														F	
Product variant	Standard														0
Integrated functional safety	Without safety function														0
Degree of protection	NEMA 1 (IP20), uncoated														0
Interference suppression	Without														0
Application	Default parameter setting: Region EU (50-Hz networks)														0
	Default parameter setting: Region US (60-Hz networks)														1
Product extension	Standard I/O ...														0
	Keypad-module with Standard I/O ...														K
	WLAN module with Standard I/O ...														W
	... without network														00S
	... with CANopen														02S
... with Modbus RTU														03S	



4 Commissioning

The purpose of commissioning is to adapt the inverter as part of a machine with a variable-speed drive system to its drive task.

4.1 Important notes

DANGER!

Incorrect wiring can cause unexpected states during the commissioning phase.

Possible consequences: death, severe injuries or damage to property

Ensure the following before switching on the mains voltage:

- ▶ Wiring must be complete and correct.
 - ▶ Wiring must be free of short circuits and earth faults.
 - ▶ The motor circuit configuration (star/delta) must be adapted to the inverter output voltage.
 - ▶ The motor must be connected in-phase (direction of rotation).
 - ▶ The "emergency off" function of the overall system must operate correctly.
-

DANGER!

Incorrect settings during commissioning may cause unexpected and dangerous motor and system movements.

Possible consequences: death, severe injuries or damage to property

- ▶ Clear hazardous area.
 - ▶ Observe safety instructions and safety clearances.
-



4.2 Initial switch-on and functional test

Drive behaviour by default

By default, the V/f characteristic control with a linear characteristic is preset as motor control for asynchronous motors. The V/f characteristic control is a motor control for conventional frequency inverter applications. It is based on a simple and robust control mode for the operation of asynchronous motors with a linear or square-law load torque characteristic (e.g. fan). Because of the minimal parameterisation effort, such applications can be commissioned easily and quickly.

The default settings of the parameters ensure that the inverter is ready for operation immediately and the motor works adequately without further parameterisation if an inverter and an asynchronous motor* Hz asynchronous machine with matching performances are assigned to each other.

* Depending on the device/mains frequency either 50-Hz asynchronous motor or 60-Hz asynchronous motor.

Functional test

Target: the motor connected to the inverter should rotate as quickly as possible.

Requirements:

- The connected motor matches the inverter in terms of power.
- The parameter settings correspond to the state upon delivery.

1. Preparation

1. Wire the power connections. See the mounting and switch-on instruction for more details.
2. Wire digital inputs X3/DI1 (start/stop), X3/DI3 (reversal) and X3/DI4 (frequency preset 20 Hz).
3. Do not connect terminal X3/AI1 (analog setpoint selection) or connect it to GND.

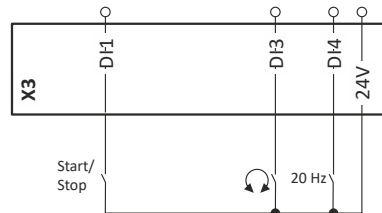

2. Switch on mains and check readiness for operation

1. Switch on mains voltage.
2. Observe LED status displays "RDY" and "ERR" on the front of the inverter:
 - a) If the blue "RDY" LED is blinking and the red "ERR" LED does not light up, the inverter is ready for operation. The controller is inhibited.
You can now start the drive.
 - b) If the red "ERR" LED is lit permanently, a fault is pending.
Eliminate the fault before you carry on with the functional test.

Commissioning

Initial switch-on and functional test



Carry out functional test

1. Start drive



1. Start inverter: X3/DI1 = HIGH.
2. Activate frequency preset 1 (20 Hz) as speed setpoint: X3/DI4 = HIGH.
The drive rotates with 20 Hz.
3. Optional: Activate reversal
 - a) X3/DI3 = HIGH.
The drive rotates at 20 Hz in the opposite direction.
 - b) Deactivate reversal again: X3/DI3 = LOW.
Speed characteristic (example)

2. Stop drive

1. Deactivate frequency preset 1 again: X3/DI4 = LOW.
2. Stop inverter again: X3/DI1 = LOW.

The functional test has been completed.

Related topics

- ▶ [Function assignment of the inputs and outputs \(default setting\)](#)  44
- ▶ [LED status display](#)  439
- ▶ [Error codes, causes and remedies](#)  461













4.3 Operating interfaces

4.3.1 Keypad

The keypad is an easy means for the local operation, parameterisation, and diagnostics of the inverter.



Function of keypad keys in operating mode			
Key	Actuation	Condition	Action
	Briefly	Local keypad control active. Display "LOC"	Run motor.
		Remote control active Display "REM" Display "KSTOP"	Deactivate keypad triggered stop. The motor remains at standstill. Display changes from "KSTOP" to "STOP".
	Briefly	No Jog operation	Stop motor. Display "KSTOP"
	Briefly	Operating mode	Change to parameterisation mode. ▶ Keypad parameterisation mode 403
	Longer than 3 s	None (anytime possible)	Save parameter settings in the user memory of the memory module.
	Briefly	During operation	Scroll through information in the above status line.
 	Briefly	Manual setpoint selection via keypad active. Display "MAN"	Change frequency setpoint.
	Briefly	Operating mode	Activate full keypad control Display "ON?" → Confirm with  Control and setpoint selection can now only be carried out via keypad. Renewed clicking: Exit full keypad control. Display "OFF?" → Confirm with  ▶ Keypad full control 53
	Briefly	Local keypad control active. Display "LOC"	Reversal of rotation direction. Display "REV?" → Confirm with  ▶ Configure R/F and CTRL keys 426

Detailed information on the keypad can be found in the Chapter "Using accessories".

▶ [Keypad](#) 399



4.3.2 Engineering tool »EASY Starter«

The »EASY Starter« is a PC software that is especially designed for the commissioning and diagnostics of the inverter.

- »EASY Starter« [Download](#)

Screenshot:

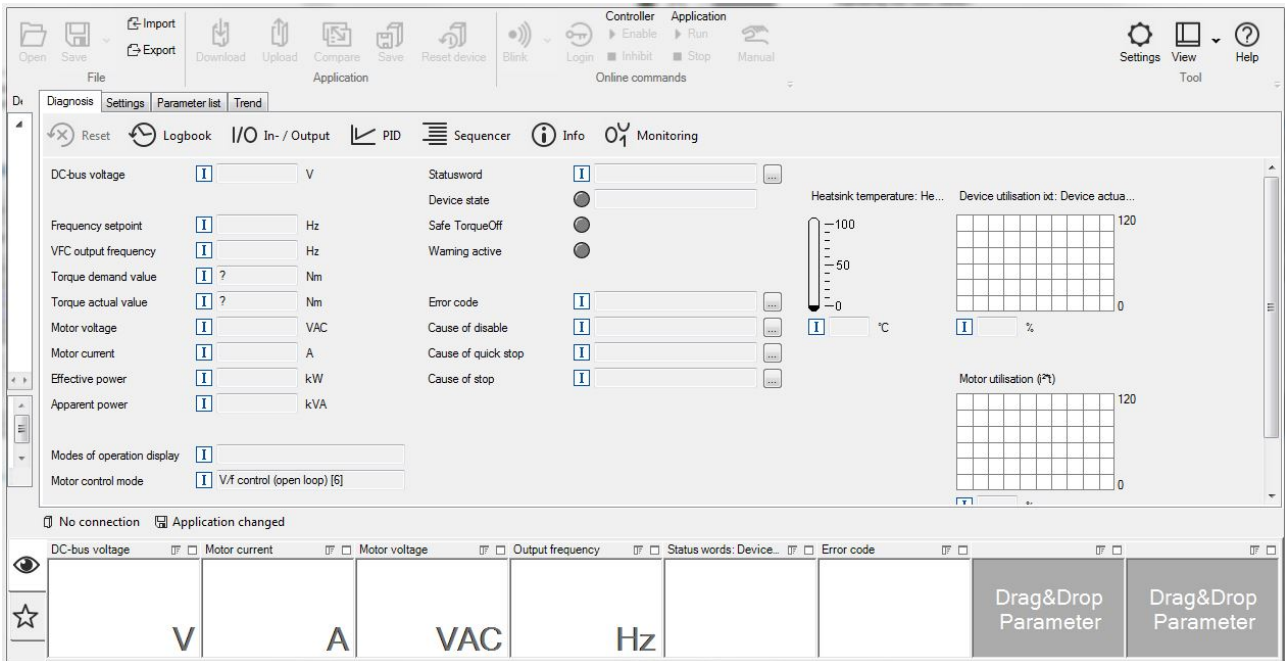



4.3.2.1 Generate a connection between inverter and »EASY Starter«

For commissioning the inverter with the »EASY Starter«, a communication link with the inverter is required. This can be established in a wired or wireless manner via WLAN.

Preconditions

- A USB module and a USB 2.0 cable (A plug on Micro-B plug) are required for wired communication.



- A WLAN module is required for wireless communication with the inverter. In addition the PC on which the »EASY Starter« is installed must be wireless-enabled.



Commissioning

Operating interfaces
Engineering tool »EASY Starter«



Details

The following instructions describe how to establish a connection via the USB module.



The USB interface must only be used temporarily for the diagnostics and parameterization of the inverter. It is recommended to always keep the inverter and the diagnostic device on the same earth potential or separate the diagnostic device from the mains.

- Parameterising without motor operation does not require a mains voltage. If you connect the inverter directly to the PC without a hub, the USB interface of the PC is sufficient for the voltage supply.
- Instructions for the establishing a connection via the WLAN module can be found in the chapter "Using accessories: [WLAN module](#)". [428](#)

How to establish a communication to the inverter via USB:

Preconditions for commissioning:

- The functional test described in the mounting and switch-on instructions has been completed successfully (without any errors or faults).
- The inverter is ready for operation. The mains voltage is switched on.

Accessories required for commissioning:

- The USB module
- The USB 2.0 cable (A-plug on micro B-plug)
- The PC with installed »EASY Starter« software

1. Plug the USB module into the front of the inverter (interface X16).
2. Use a USB cable to connect the inverter to the PC on which »EASY Starter« is installed:
 - a) Plug the micro B plug of the USB cable into the socket of the USB module.
 - b) Plug the other end into a free USB type A-socket of the PC.
3. Start »EASY Starter«.
The "Add devices" dialog is shown.
4. Select the "USB - USB with module i5MADU0000000S" connection:

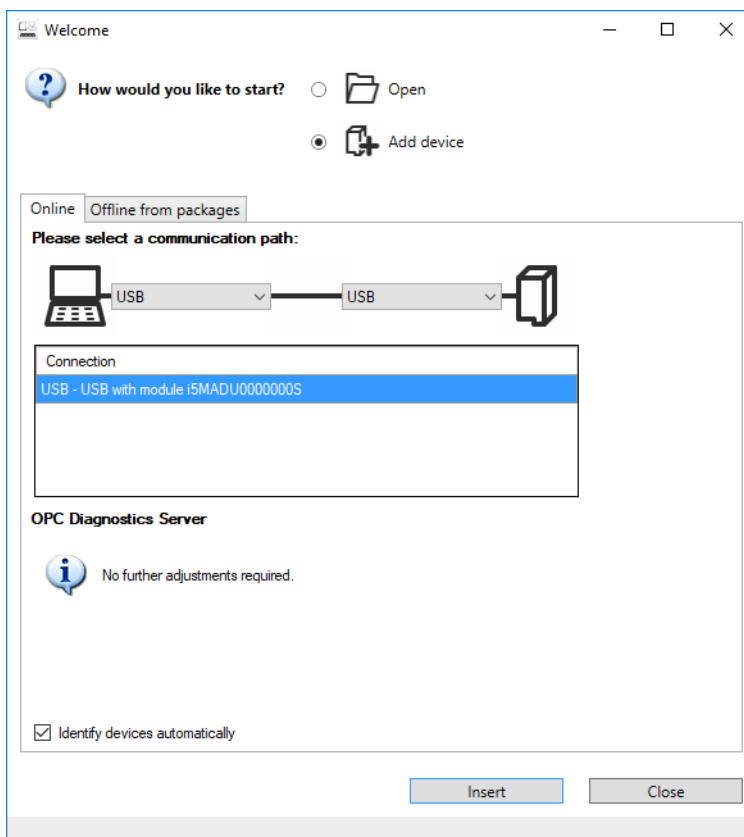



5. Click the **Insert** button.

»EASY Starter« searches for connected devices via the communication path selected. When the connection has been established successfully, the inverter is displayed in the device list of »EASY Starter«. The inverter parameters can now be accessed via the tabs of »EASY Starter«.

4.3.3 SMART Keypad App

The Lenze »SMART Keypad App« for Android or iOS allows you to diagnose and parameterize an inverter. A WLAN module on the inverter is required for communication.

- Ideal for the parameterization of simple applications such as a conveyor belt.
- Ideal for the diagnostics of the inverter.

The app can be found in the Google Play Store or in the Apple App Store.

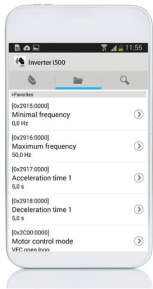

Android



iOS

Commissioning

General information on parameter setting
Addressing of the parameters



4.4 General information on parameter setting

As a part of a machine with a speed-variable drive system, the inverter must be adapted to its drive task. The adaptation process of the inverter is carried out by changing parameters. These parameters can be accessed by means of the keypad or »EASY Starter«. If the inverter is provided with a network option, access can also be effected by a higher-level controller via the corresponding network.



Certain device commands or settings which might cause a critical state of the drive behavior can only be carried out when the device is disabled.

4.4.1 Addressing of the parameters

Each parameter features a 16-bit index as its address. Under this address, the parameter is stored in the object directory of the device.

- Parameters that belong together functionally are combined in a data set. These parameters are additionally provided with an 8-bit subindex.
- The colon is used as a separator between the index and subindex Example: "0x2540:001"
- There are parameter settings that can be changed, and (diagnostic) parameters that can only be read.

Parameterisation using the keypad

- All parameters which can also be accessed by means of the keypad have a "Display code", with the first digit of the display code specifying the group in which the parameter can be found on the keypad.
- In the documentation, the display code is specified in brackets behind the address. Example: "0x2915 (P210.00)".



4.4.2 Structure of the parameter descriptions

- The parameter descriptions in this documentation are structured in table form.
- The representation distinguishes parameters with a setting range, text, selection list, and bit-coded display.
- The default setting of parameters with a write access feature is shown in **bold**.
- The display code as well as the short keypad designation of the parameter, which is limited to 16 characters, are shown in brackets.

Example: parameters with a setting range

Address	Name / setting range / [default setting]	Information
Index:Subindex (display code)	Parameter designation (abbreviated keypad designation) Minimum value ... [default setting] ... maximum value • Optional information with regard to the parameter.	Explanations and notes with regard to the parameter.

Example: parameters with a selection list

Address	Name / setting range / [default setting]	Information
Index:Subindex (display code)	Parameter designation (abbreviated keypad designation) • Optional information with regard to the parameter.	Explanations and notes with regard to the parameter. Note: The corresponding selection number (here 0, 1, or 2) must be set. Other values are not permissible.
	0 Designation of selection 0	Optionally: explanations and notes with regard to the corresponding selection.
	1 Designation of selection 1	
	2 Designation of selection 2	The default selection is shown in bold .

Example: parameters with a bit-coded display

Address	Name / setting range / [default setting]	Information
Index:Subindex (display code)	Parameter designation (abbreviated keypad designation) • Optional information with regard to the parameter.	Explanations and notes with regard to the parameter.
	Bit 0 Designation of bit 0	Optionally: explanations and notes with regard to the corresponding bit.
	Bit 1 Designation of bit 1	
	Bit 2 Designation of bit 2	
	
	Bit 15 Designation of bit 15	

4.4.3 Parameter overview lists

- [Keypad parameter list](#): for the parameterisation using the keypad, contains a list of all parameters which can also be accessed by means of the keypad. [📄 407](#)
- [Parameter attribute list](#): contains a list of all inverter parameters. This list in particular includes some information that is relevant for the reading and writing of parameters via the network. [📄 480](#)

Commissioning

General information on parameter setting
Favorites



4.4.4 Favorites

In order to gain quick access using »EASY Starter« or the keypad, frequently used parameters of the inverter can be defined as "Favorites".

- The *Favorites* tab in »EASY Starter« is used to quickly access the favorites.
- On the keypad, the "Favorites" can be found in group 0.

4.4.4.1 Accessing the "Favorites" with the keypad

1. VEL:FLEX#AIN1
STOP
REM AUTO SET-I
2. Favorites
GROUP 0
REM AUTO SET-I
3. Output frequency
P10000
REM AUTO SET-I
4. Accel time 1
P22000
REM AUTO SET-I
5. P220.00 s
5.0
REM AUTO SET-I
6. P220.00 s
8.0
REM AUTO SET-I

1. Use the key in the operating mode to navigate to the parameterisation mode one level below.

You are now in the group level. All parameters of the inverter are divided into different groups according to their function.

Group 0 contains the "Favorites".

Note: By using the key you can navigate one level upwards again anytime.

2. Use the key to navigate to one level below.

You are now in the parameter level of the group selected.

3. Use the and navigation keys to select the desired parameter.

4. Use the key to navigate to one level below.

You are now in the editing mode.

5. Set the desired value using the and navigation keys.

6. Use the key to accept the changed setting.

The editing mode is exited.

Note: By using the key you can exit the editing mode without accepting the new setting (abort).

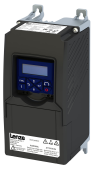

4.4.4.2 Favorites parameter list (default setting)

In the default setting, parameters for resolving typical applications are defined as "Favorites".

No.	Display code	Name	Default setting	Setting range	Information
1	P100.00	Inv. outp. freq.	x.x Hz	- (Read only)	0x2DDD
2	P103.00	Actual current	x.x %	- (Read only)	0x6078
3	P106.00	Motor voltage	x VAC	- (Read only)	0x2D89
4	P150.00	Error code	-	- (Read only)	0x603F
5	P200.00	Control select.	Flexible I/O [0]	Selection list	0x2824
6	P201.01	Freq. setp. src.	Analog input 1 [2]	Selection list	0x2860:001
7	P203.01	Start method	Normal [0]	Selection list	0x2838:001
8	P203.03	Stop method	Standard ramp [1]	Selection list	0x2838:003
9	P208.01	Mains voltage	230 Veff [0]	Selection list	0x2540:001
10	P210.00	Min. frequency	0.0 Hz	0.0 ... 599.0 Hz	0x2915
11	P211.00	Max. frequency	50.0 Hz* 60.0 Hz**	0.0 ... 599.0 Hz	0x2916
12	P220.00	Accelerat.time 1	5.0 s	0.0 ... 3600.0 s	0x2917
13	P221.00	Decelerat.time 1	5.0 s	0.0 ... 3600.0 s	0x2918
14	P300.00	Motor ctrl mode	VFC open loop [6]	Selection list	0x2C00
15	P302.00	V/f charac.shape	Linear [0]	Selection list	0x2B00
16	P303.01	Base voltage	230 V	0 ... 5000 V	0x2B01:001
17	P303.02	Base frequency	50 Hz* 60 Hz**	0 ... 1500 Hz	0x2B01:002
18	P304.00	Limit. rotation	Both rot. direct [1]	Selection list	0x283A
19	P305.00	Switching freq.	0	1 ... 33	0x2939
20	P306.01	Duty selection	Heavy Duty [0]	Selection list	0x2D43:001
21	P308.01	Max.load.for 60s	150 %	30 ... 200 %	0x2D4B:001
22	P316.01	Fixed V/f boost	2.5 %	0.0 ... 20.0 %	0x2B12:001
23	P323.00	Rated mot.curr.	1.700 A	0.001 ... 500.000 A	0x6075
24	P324.00	Max. current	200.0 %	0.0 ... 3000.0 %	0x6073
25	P400.01	Enable inverter	TRUE [1]	Trigger list 59	0x2631:001
26	P400.02	Run	Digital input 1 [11]	Trigger list 59	0x2631:002
27	P400.03	Quick stop	Not connected [0]	Trigger list 59	0x2631:003
28	P400.04	Reset fault	Digital input 2 [12]	Trigger list 59	0x2631:004
29	P400.05	DC braking	Not connected [0]	Trigger list 59	0x2631:005
30	P400.06	Start forward	Not connected [0]	Trigger list 59	0x2631:006
31	P400.07	Start reverse	Not connected [0]	Trigger list 59	0x2631:007
32	P400.08	Run forward	Not connected [0]	Trigger list 59	0x2631:008
33	P400.09	Run reverse	Not connected [0]	Trigger list 59	0x2631:009
34	P400.13	Reverse rot.dir.	Digital input 3 [13]	Trigger list 59	0x2631:013
35	P400.18	Setp: Preset b0	Digital input 4 [14]	Trigger list 59	0x2631:018
36	P400.19	Setp: Preset b1	Digital input 5 [15]	Trigger list 59	0x2631:019
37	P400.20	Setp: Preset b2	Not connected [0]	Trigger list 59	0x2631:020
38	P420.01	Relay function	Rdy for operat. [51]	Selection list	0x2634:001
39	P420.02	DO1 function	Release brake [115]	Selection list	0x2634:002
40	P430.01	AI1 input range	0 ... 10 VDC [0]	Selection list	0x2636:001
41	P430.02	AI1 freq @ min	0.0 Hz	-1000.0 ... 1000.0 Hz	0x2636:002
42	P430.03	AI1 freq @ max	50.0 Hz* 60.0 Hz**	-1000.0 ... 1000.0 Hz	0x2636:003
43	P440.01	AO1 outp. range	0 ... 10 VDC [1]	Selection list	0x2639:001
44	P440.02	AO1 function	Outp. frequency [1]	Selection list	0x2639:002
45	P440.03	AO1 min. signal	0	-2147483648 ... 2147483647	0x2639:003
46	P440.04	AO1 max. signal	1000	-2147483648 ... 2147483647	0x2639:004
47	P450.01	Freq. preset 1	20.0 Hz	0.0 ... 599.0 Hz	0x2911:001
48	P450.02	Freq. preset 2	40.0 Hz	0.0 ... 599.0 Hz	0x2911:002
49	P450.03	Freq. preset 3	50.0 Hz* 60.0 Hz**	0.0 ... 599.0 Hz	0x2911:003
50	P450.04	Freq. preset 4	0.0 Hz	0.0 ... 599.0 Hz	0x2911:004

* Device for 50-Hz mains ** Device for 60-Hz mains

Commissioning

General information on parameter setting
Favorites



4.4.4.3 Configuring the "Favorites"

The "Favorites" can be configured by the user.

Details

A maximum number of 50 parameters can be defined as "Favorites".

The easiest way to process the selection of the favorites is via the parameterisation dialog in the »EASY Starter«:

1. Change to the "Parameter list" tab.
2. Select group 0 - Favorites.
3. Click the  button.
4. Process favorites:

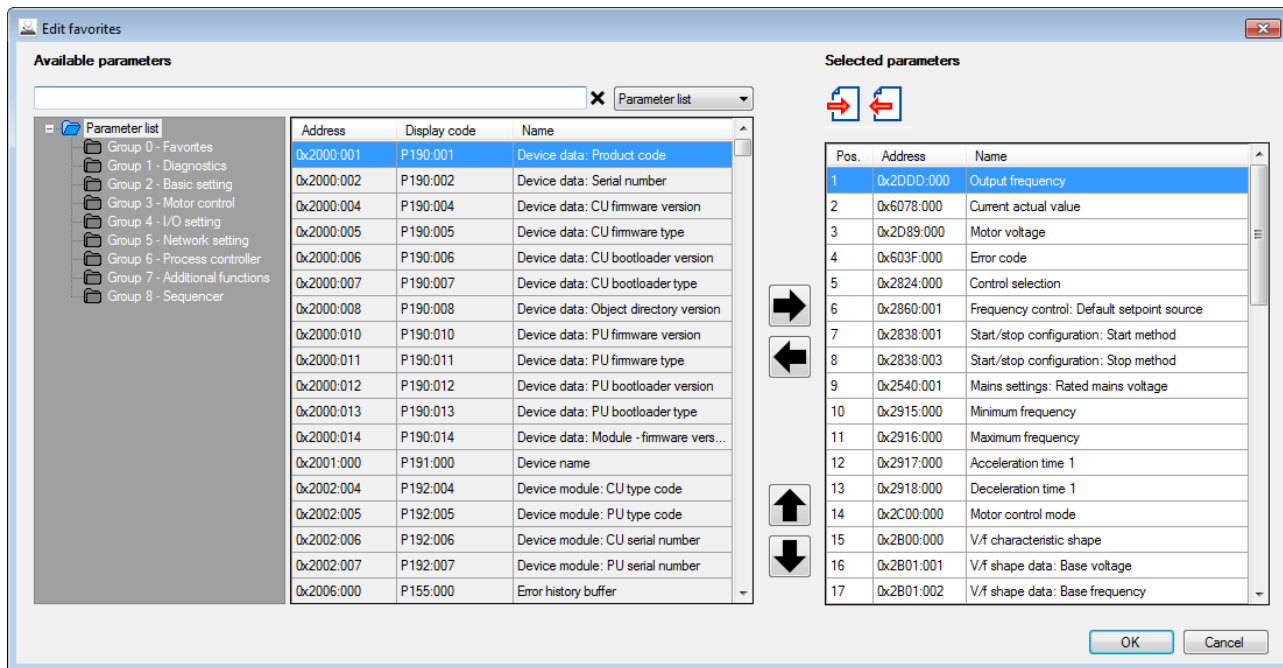

The default favorites can be modified using the keypad or via the network with the following parameters:

Parameter

Address	Name / setting range / [default setting]	Information
0x261C:001 (P740.01)	Favorites settings: Parameter 1 (Favorites sett.: Parameter 1) 0x00000000 ... [0x2DDD0000] ... 0xFFFFFFFF00	Definition of the "Favorites" parameters. <ul style="list-style-type: none"> • Format: 0xiiii00 (iiii = hexadecimal index, ss = hexadecimal subindex) • The lowest byte is always 0x00. • The keypad can be used to select the desired parameter from a list.
0x261C:002 (P740.02)	Favorites settings: Parameter 2 (Favorites sett.: Parameter 2) 0x00000000 ... [0x60780000] ... 0xFFFFFFFF00	
0x261C:003 (P740.03)	Favorites settings: Parameter 3 (Favorites sett.: Parameter 3) 0x00000000 ... [0x2D890000] ... 0xFFFFFFFF00	
0x261C:004 (P740.04)	Favorites settings: Parameter 4 (Favorites sett.: Parameter 4) 0x00000000 ... [0x603F0000] ... 0xFFFFFFFF00	
0x261C:005 (P740.05)	Favorites settings: Parameter 5 (Favorites sett.: Parameter 5) 0x00000000 ... [0x28240000] ... 0xFFFFFFFF00	
0x261C:006 (P740.06)	Favorites settings: Parameter 6 (Favorites sett.: Parameter 6) 0x00000000 ... [0x28601000] ... 0xFFFFFFFF00	
0x261C:007 (P740.07)	Favorites settings: Parameter 7 (Favorites sett.: Parameter 7) 0x00000000 ... [0x28380100] ... 0xFFFFFFFF00	



Commissioning

General information on parameter setting
Favorites

Address	Name / setting range / [default setting]	Information
0x261C:008 (P740.08)	Favorites settings: Parameter 8 (Favorites sett.: Parameter 8) 0x00000000 ... [0x28380300] ... 0xFFFFFFFF00	
0x261C:009 (P740.09)	Favorites settings: Parameter 9 (Favorites sett.: Parameter 9) 0x00000000 ... [0x25400100] ... 0xFFFFFFFF00	
0x261C:010 (P740.10)	Favorites settings: Parameter 10 (Favorites sett.: Parameter 10) 0x00000000 ... [0x29150000] ... 0xFFFFFFFF00	
0x261C:011 (P740.11)	Favorites settings: Parameter 11 (Favorites sett.: Parameter 11) 0x00000000 ... [0x29160000] ... 0xFFFFFFFF00	
0x261C:012 (P740.12)	Favorites settings: Parameter 12 (Favorites sett.: Parameter 12) 0x00000000 ... [0x29170000] ... 0xFFFFFFFF00	
0x261C:013 (P740.13)	Favorites settings: Parameter 13 (Favorites sett.: Parameter 13) 0x00000000 ... [0x29180000] ... 0xFFFFFFFF00	
0x261C:014 (P740.14)	Favorites settings: Parameter 14 (Favorites sett.: Parameter 14) 0x00000000 ... [0x2C000000] ... 0xFFFFFFFF00	
0x261C:015 (P740.15)	Favorites settings: Parameter 15 (Favorites sett.: Parameter 15) 0x00000000 ... [0x2B000000] ... 0xFFFFFFFF00	
0x261C:016 (P740.16)	Favorites settings: Parameter 16 (Favorites sett.: Parameter 16) 0x00000000 ... [0x2B010100] ... 0xFFFFFFFF00	
0x261C:017 (P740.17)	Favorites settings: Parameter 17 (Favorites sett.: Parameter 17) 0x00000000 ... [0x2B010200] ... 0xFFFFFFFF00	
0x261C:018 (P740.18)	Favorites settings: Parameter 18 (Favorites sett.: Parameter 18) 0x00000000 ... [0x283A0000] ... 0xFFFFFFFF00	
0x261C:019 (P740.19)	Favorites settings: Parameter 19 (Favorites sett.: Parameter 19) 0x00000000 ... [0x29390000] ... 0xFFFFFFFF00	
0x261C:020 (P740.20)	Favorites settings: Parameter 20 (Favorites sett.: Parameter 20) 0x00000000 ... [0x2D430100] ... 0xFFFFFFFF00	
0x261C:021 (P740.21)	Favorites settings: Parameter 21 (Favorites sett.: Parameter 21) 0x00000000 ... [0x2D4B0100] ... 0xFFFFFFFF00	
0x261C:022 (P740.22)	Favorites settings: Parameter 22 (Favorites sett.: Parameter 22) 0x00000000 ... [0x2B120100] ... 0xFFFFFFFF00	
0x261C:023 (P740.23)	Favorites settings: Parameter 23 (Favorites sett.: Parameter 23) 0x00000000 ... [0x60750000] ... 0xFFFFFFFF00	
0x261C:024 (P740.24)	Favorites settings: Parameter 24 (Favorites sett.: Parameter 24) 0x00000000 ... [0x60730000] ... 0xFFFFFFFF00	
0x261C:025 (P740.25)	Favorites settings: Parameter 25 (Favorites sett.: Parameter 25) 0x00000000 ... [0x26310100] ... 0xFFFFFFFF00	
0x261C:026 (P740.26)	Favorites settings: Parameter 26 (Favorites sett.: Parameter 26) 0x00000000 ... [0x26310200] ... 0xFFFFFFFF00	
0x261C:027 (P740.27)	Favorites settings: Parameter 27 (Favorites sett.: Parameter 27) 0x00000000 ... [0x26310300] ... 0xFFFFFFFF00	
0x261C:028 (P740.28)	Favorites settings: Parameter 28 (Favorites sett.: Parameter 28) 0x00000000 ... [0x26310400] ... 0xFFFFFFFF00	

Commissioning

General information on parameter setting
Favorites



Address	Name / setting range / [default setting]	Information
0x261C:029 (P740.29)	Favorites settings: Parameter 29 (Favorites sett.: Parameter 29) 0x00000000 ... [0x26310500] ... 0xFFFFFFFF00	
0x261C:030 (P740.30)	Favorites settings: Parameter 30 (Favorites sett.: Parameter 30) 0x00000000 ... [0x26310600] ... 0xFFFFFFFF00	
0x261C:031 (P740.31)	Favorites settings: Parameter 31 (Favorites sett.: Parameter 31) 0x00000000 ... [0x26310700] ... 0xFFFFFFFF00	
0x261C:032 (P740.32)	Favorites settings: Parameter 32 (Favorites sett.: Parameter 32) 0x00000000 ... [0x26310800] ... 0xFFFFFFFF00	
0x261C:033 (P740.33)	Favorites settings: Parameter 33 (Favorites sett.: Parameter 33) 0x00000000 ... [0x26310900] ... 0xFFFFFFFF00	
0x261C:034 (P740.34)	Favorites settings: Parameter 34 (Favorites sett.: Parameter 34) 0x00000000 ... [0x26310D00] ... 0xFFFFFFFF00	
0x261C:035 (P740.35)	Favorites settings: Parameter 35 (Favorites sett.: Parameter 35) 0x00000000 ... [0x26311200] ... 0xFFFFFFFF00	
0x261C:036 (P740.36)	Favorites settings: Parameter 36 (Favorites sett.: Parameter 36) 0x00000000 ... [0x26311300] ... 0xFFFFFFFF00	
0x261C:037 (P740.37)	Favorites settings: Parameter 37 (Favorites sett.: Parameter 37) 0x00000000 ... [0x26311400] ... 0xFFFFFFFF00	
0x261C:038 (P740.38)	Favorites settings: Parameter 38 (Favorites sett.: Parameter 38) 0x00000000 ... [0x26340100] ... 0xFFFFFFFF00	
0x261C:039 (P740.39)	Favorites settings: Parameter 39 (Favorites sett.: Parameter 39) 0x00000000 ... [0x26340200] ... 0xFFFFFFFF00	
0x261C:040 (P740.40)	Favorites settings: Parameter 40 (Favorites sett.: Parameter 40) 0x00000000 ... [0x26360100] ... 0xFFFFFFFF00	
0x261C:041 (P740.41)	Favorites settings: Parameter 41 (Favorites sett.: Parameter 41) 0x00000000 ... [0x26360200] ... 0xFFFFFFFF00	
0x261C:042 (P740.42)	Favorites settings: Parameter 42 (Favorites sett.: Parameter 42) 0x00000000 ... [0x26360300] ... 0xFFFFFFFF00	
0x261C:043 (P740.43)	Favorites settings: Parameter 43 (Favorites sett.: Parameter 43) 0x00000000 ... [0x26390100] ... 0xFFFFFFFF00	
0x261C:044 (P740.44)	Favorites settings: Parameter 44 (Favorites sett.: Parameter 44) 0x00000000 ... [0x26390200] ... 0xFFFFFFFF00	
0x261C:045 (P740.45)	Favorites settings: Parameter 45 (Favorites sett.: Parameter 45) 0x00000000 ... [0x26390300] ... 0xFFFFFFFF00	
0x261C:046 (P740.46)	Favorites settings: Parameter 46 (Favorites sett.: Parameter 46) 0x00000000 ... [0x26390400] ... 0xFFFFFFFF00	
0x261C:047 (P740.47)	Favorites settings: Parameter 47 (Favorites sett.: Parameter 47) 0x00000000 ... [0x29110100] ... 0xFFFFFFFF00	
0x261C:048 (P740.48)	Favorites settings: Parameter 48 (Favorites sett.: Parameter 48) 0x00000000 ... [0x29110200] ... 0xFFFFFFFF00	
0x261C:049 (P740.49)	Favorites settings: Parameter 49 (Favorites sett.: Parameter 49) 0x00000000 ... [0x29110300] ... 0xFFFFFFFF00	



Address	Name / setting range / [default setting]	Information
0x261C:050 (P740.50)	Favorites settings: Parameter 50 (Favorites sett.: Parameter 50) 0x00000000 ... [0x29110400] ... 0xFFFFFFFF	

4.5 Saving the parameter settings

4.5.1 Save parameter settings with keypad

If one parameter setting has been changed with the keypad but has not been saved in the memory module with mains failure protection, the SET display is blinking.

In order to save parameter settings in the user memory of the memory module, press and hold the enter key for longer than 3 s.

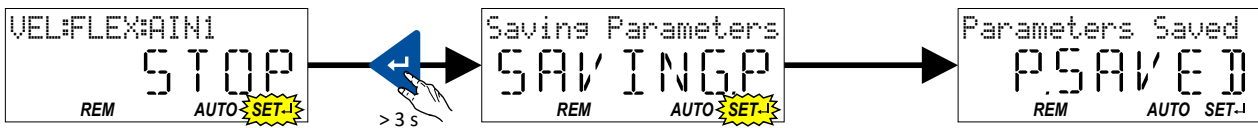

4.5.2 Save parameter settings with »EASY Starter«

If a parameter setting has been changed with the »EASY Starter« but not yet saved in the memory medium with mains failure protection, the status line of the »EASY Starter« displays the note "The parameter set was changed".

There are 3 options to save the parameter settings in the user memory of the storage medium

- Click the button in the toolbar of the »EASY Starter« .
- Press the function key F6.
- Execute the device command "Save user data": 0x2022:003 (P700.03) = "On / start [1]".

4.5.3 Saving the settings

Parameter

Address	Name / setting range / [default setting]	Information
0x2829 (P732.00)	Automatic storage in the memory module (Auto-Save EPM)	1 = Activate automatic saving of parameters in the memory module. Saving is undertaken to a parameter stored on the memory module with each write cycle. An excessively high number of write cycles reduces the service life of the memory module. <ul style="list-style-type: none"> • With the setting 0, the "Save user data" 0x2022:003 (P700.03) device command must be explicitly executed, or the enter key must be pressed and held for longer than 3 s to save the current parameter settings in the memory module of the inverter with mains failure protection. Warning The "Automatic saving" function must not be used together with cyclical writing of parameters via PDO.
	0 Inhibit 1 Enable	

Basic setting

Device name



5 Basic setting

5.1 Device name

Parameter

Address	Name / setting range / [default setting]	Information
0x2001 (P191.00)	Device name (Device name) ["My Device"]	Any device name can be set in this object for the purpose of device identification.

5.2 Mains voltage

The rated mains voltage set for the inverter has an impact on the operating range of the inverter.

Parameter

Address	Name / setting range / [default setting]	Information														
0x2540:001 (P208.01)	Mains settings: Rated mains voltage (Mains settings: Mains voltage) <ul style="list-style-type: none"> Setting can only be changed if the inverter is disabled. <table border="1"> <tr> <td>0</td> <td>230 Veff</td> </tr> <tr> <td>1</td> <td>400 Veff</td> </tr> <tr> <td>2</td> <td>480 Veff</td> </tr> <tr> <td>3</td> <td>120 Veff</td> </tr> <tr> <td>5</td> <td>480 Veff (600 V devices)</td> </tr> <tr> <td>6</td> <td>600 Veff</td> </tr> <tr> <td>10</td> <td>230 Veff/reduced LU level</td> </tr> </table>	0	230 Veff	1	400 Veff	2	480 Veff	3	120 Veff	5	480 Veff (600 V devices)	6	600 Veff	10	230 Veff/reduced LU level	Selection of the mains voltage for actuating the inverter.
0	230 Veff															
1	400 Veff															
2	480 Veff															
3	120 Veff															
5	480 Veff (600 V devices)															
6	600 Veff															
10	230 Veff/reduced LU level															
0x2540:002 (P208.02)	Mains settings: Undervoltage warning threshold (Mains settings: LU warn. thresh.) 0 ... [0]* ... 1000 V * Default setting dependent on the model.	Monitoring for undervoltage (LU) in the DC bus: Setting of the warning threshold. <ul style="list-style-type: none"> If the DC voltage in the DC bus falls below the threshold set, the inverter outputs a warning. The warning is reset with a hysteresis of 10 V. 														
0x2540:003 (P208.03)	Mains settings: Undervoltage error threshold (Mains settings: LU error thresh.) <ul style="list-style-type: none"> Read only: x V 	Monitoring for undervoltage (LU) in the DC bus: Display of the fixed threshold. <ul style="list-style-type: none"> If the DC voltage in the DC bus falls below the threshold displayed, the error"" response is triggered. 														
0x2540:004 (P208.04)	Mains settings: Undervoltage reset threshold (Mains settings: LU reset thresh.) <ul style="list-style-type: none"> Read only: x V 	Display of the fixed reset threshold for monitoring DC bus undervoltage.														
0x2540:005 (P208.05)	Mains settings: Overvoltage warning threshold (Mains settings: OU warn. thresh.) 0 ... [0]* ... 1000 V * Default setting dependent on the model.	Monitoring for overvoltage (OU) in the DC bus: Setting of the warning threshold. <ul style="list-style-type: none"> If the DC bus voltage exceeds the threshold set, the inverter outputs a warning. The warning is reset with a hysteresis of 10 V. 														
0x2540:006 (P208.06)	Mains settings: Overvoltage error threshold (Mains settings: OU error thresh.) <ul style="list-style-type: none"> Read only: x V 	Monitoring for overvoltage (OU) in the DC bus: Display of the fixed threshold. <ul style="list-style-type: none"> If the DC-bus voltage exceeds the threshold displayed, the "Fault" response is triggered. 														
0x2540:007 (P208.07)	Mains settings: Overvoltage reset threshold (Mains settings: OU reset thresh.) <ul style="list-style-type: none"> Read only: x V 	Display of the fixed reset threshold for monitoring DC bus overvoltage.														



5.3 Dual rating

The inverter has two different load characteristics: "Light Duty" and "Heavy Duty". The load characteristic "Light Duty" enables a higher output current with restrictions regarding overload capacity, ambient temperature and switching frequency. As a result, the motor can be driven by a less powerful inverter. The selected load characteristic depends on the application.

NOTICE

Load characteristic "Light Duty"

In order to avoid irreversible damage to the inverter/motor:

- ▶ Based on the configuration document, check whether the inverter can be operated with the load characteristic "Light Duty".
- ▶ Comply with all data in the configuration document for this load characteristic and the corresponding mains voltage range. Among other things, this includes information on the type of installation and required fuses, cable cross-sections, mains chokes and filters.
- ▶ Set the parameters only in accordance with the following specifications .

Details

The following table compares the two load characteristics:

	Duty selection 0x2D43:001 (P306.01)	
	"Heavy Duty [0]"	"Light Duty [1]"
Characteristics	High dynamic requirements	Low dynamic requirements
Typical applications	Main tool drives, travelling drives, hoist drives, winders, forming drives, and conveyors.	Centrifugal pumps, fans, general horizontal materials handling technology, line drives and centrifugal pumps.
Overload capacity	3 s/200 %, 60 s/150 % For details see configuration document	Reduced overload For details see configuration document



If the inverter is reset to the default setting, the load characteristic is set to "Heavy Duty [0]".

Parameter

Address	Name / setting range / [default setting]	Information
0x2D43:001 (P306.01)	Inverter load characteristic: Duty selection (Inv. load char.: Duty selection) • Setting can only be changed if the inverter is disabled.	Selection of the load characteristic. Further required settings: • Set the data of the motor used. • Set application-specific parameters such as current limits.
	0 Heavy Duty	Load characteristic for high dynamic requirements.
	1 Light Duty	Load characteristic for low dynamic requirements. • The device overload monitoring (i*t) is adapted. ⚠ CAUTION! Observe the information in the configuration document for this load characteristic.

Related topics

- ▶ [Motor data](#) 45
- ▶ [Maximum overload current of the inverter](#) 233

Basic setting

Frequency limits



5.4 Frequency limits

The frequency range can be limited by setting a minimum and maximum frequency.

Parameter

Address	Name / setting range / [default setting]	Information
0x2915 (P210.00)	Minimum frequency (Min. frequency) 0.0 ... [0.0] ... 599.0 Hz	Lower limit value for all frequency setpoints.
0x2916 (P211.00)	Maximum frequency (Max. frequency) Device for 50-Hz mains: 0.0 ... [50.0] ... 599.0 Hz Device for 60-Hz mains: 0.0 ... [60.0] ... 599.0 Hz	Upper limit value for all frequency setpoints.



5.5 Start behavior

The start can be optionally made with DC braking or flying restart circuit. Moreover, an automatic start can be activated after switch-on.

Details

The start method can be selected in `0x2838:001 (P203.01)`. The following diagram demonstrates the different start methods:

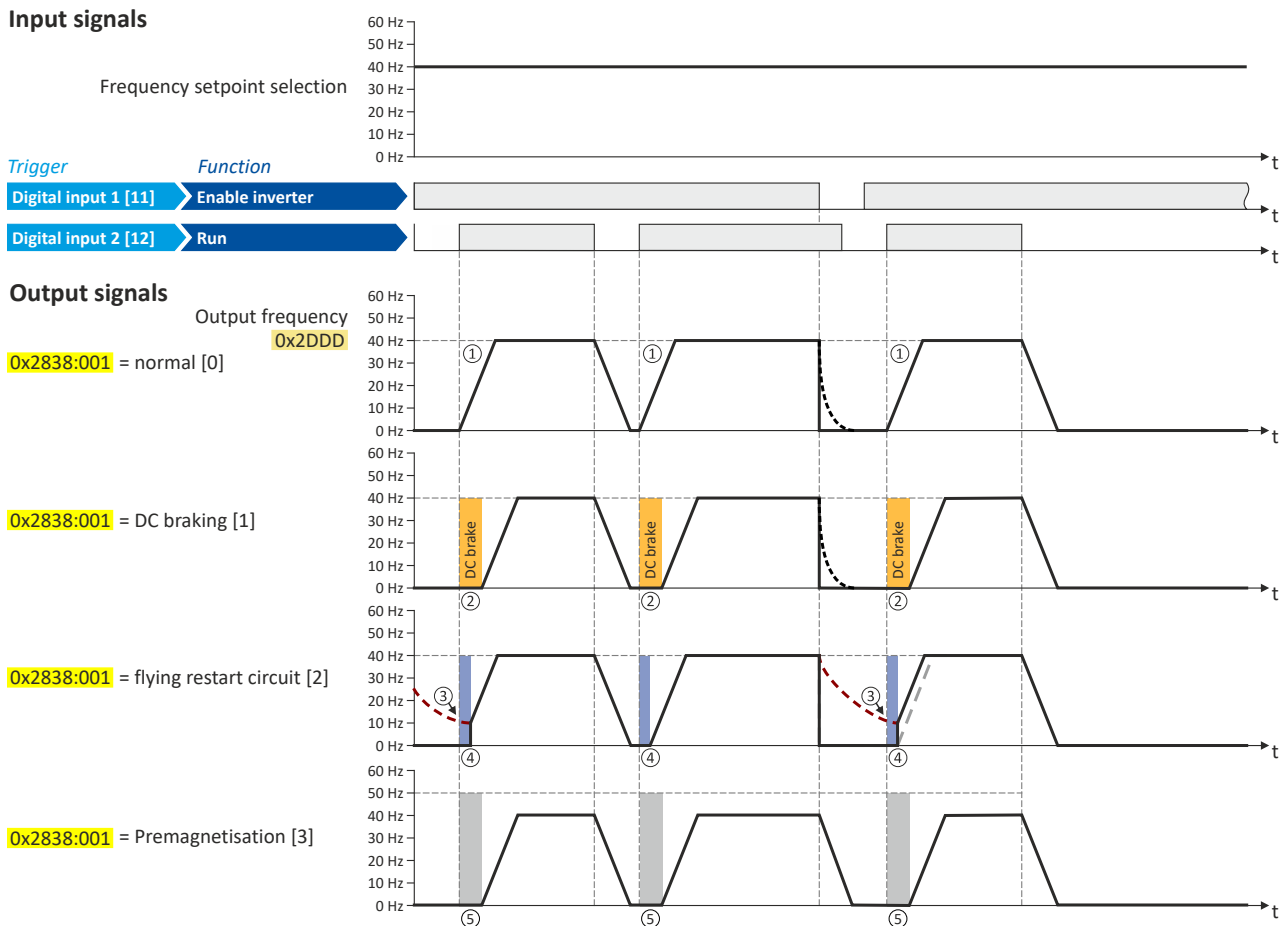

- ① Start method = "Normal [0]": After the start command, the motor is accelerated to the setpoint with the set acceleration time.
- ② Start method = "DC braking [1]": After the start command, the "DC braking" function is active. Only after the hold time set in `0x2B84:002 (P704.02)` has elapsed is the motor accelerated to the setpoint with the set acceleration time.
 ▶ [DC braking](#) □ 190
- ③ For demonstrating the flying restart circuit: At the time of the start command, the motor is not at a standstill (for instance due to loads with high inertia such as fans or flywheels).
- ④ Start method = "Flying restart circuit [2]": After the start command, the flying restart circuit is active. The flying restart circuit serves to restart a coasting motor on the fly during operation without speed feedback. The synchronicity between inverter and motor is coordinated so that the transition to the rotating motor is effected without jerk at the time of connection.
 ▶ [Flying restart circuit](#) □ 182
- ⑤ Start method = "Pre-magnetisation [3]": normal start and premagnetisation - this setting corresponds to the setting [0] normal, but adds the premagnetisation of the motor before the motor rotation begins. The premagnetisation property is generally relevant when operating in V/f motor control modes.

Some asynchronous motors which have a lower stator resistance can experience high amperages when accelerating from a stopped/deactivated state. The premagnetisation property can reduce the motor current during the acceleration and is able to generate a more even acceleration curve with this motor. A property of the start method is a slight delay before the motor acceleration begins.

Basic setting

Start behavior



Automatic start after switching on the mains voltage

The automatic start can be activated in [0x2838:002 \(P203.02\)](#).

Preconditions for the automatic start:

- The flexible I/O configuration is selected: [0x2824 \(P200.00\)](#) = "Flexible I/O configuration [0]"
- For the start command, a digital input has been configured. (In case of keypad or activated network control, an automatic start is not possible.)

The following diagram demonstrates the function:

Input signals

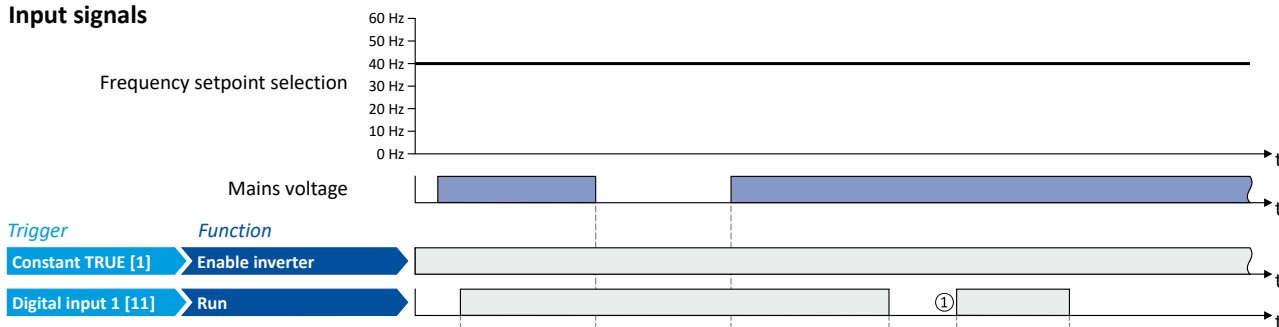

Output signals

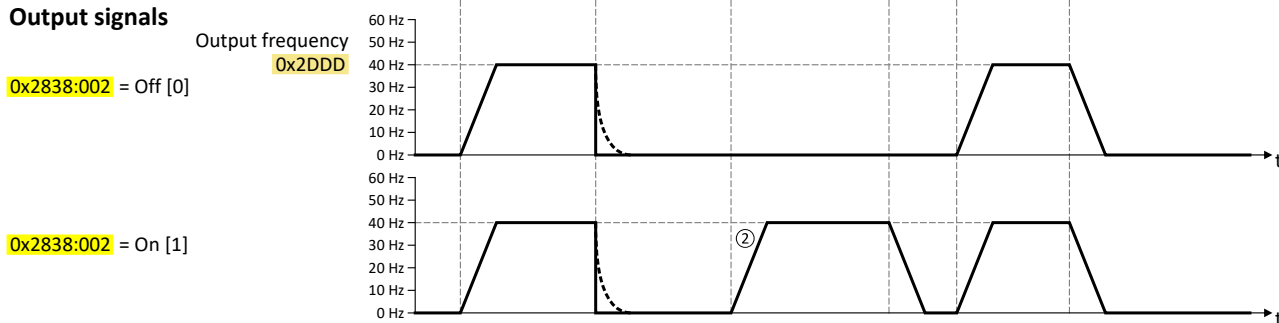

- ① Start at power-up = "Off [0]": After switching on the mains voltage, a renewed start command is required to start the motor.
- ② Start at power-up = "On [1]": After switching on the mains voltage, the motor starts automatically if a start command is present.



Parameter

Address	Name / setting range / [default setting]	Information
0x2838:001 (P203.01)	Start/stop configuration: Start method (Start/stop cfg: Start method) • Setting can only be changed if the inverter is disabled.	Response after starting command.
	0 Normal	After start command, the standard ramps are active. • Acceleration time 1 can be set in 0x2917 (P220.00) . • Deceleration time 1 can be set in 0x2918 (P221.00) .
	1 DC braking	After start command, the "DC braking" function is active for the time set in 0x2B84:002 (P704.02) . ▶ DC braking 190 ⚠ CAUTION! Deactivate automatic DC braking, if a holding brake is used.
	2 Flying restart circuit	After the start command, the flying restart circuit is active. The flying restart function makes it possible to restart a coasting motor during operation without speed feedback. The course between the inverter and motor is coordinated so that the transition to the rotating motor is effected without jerk at the time of connection. ▶ Flying restart circuit 182
	3 Pre-magnetisation (from version 05.03)	This setting corresponds to the setting [0] Normal, but adds the premagnetisation of the motor before the rotation/acceleration begins. The premagnetisation can reduce the motor current during the acceleration and generate a more even acceleration curve (by avoiding overcurrent situations). The premagnetisation function is relevant when operating in V/f motor control modes. The premagnetisation causes a slight delay before the motor acceleration begins (typically 50-200 ms, depending on motor characteristic).
0x2838:002 (P203.02)	Start/stop configuration: Start at power-up (Start/stop cfg: Start at powerup)	Start behavior after switching on the mains voltage.
	0 Off	No automatic start after switching on mains voltage. In addition to the inverter enable, a renewed start command is always required to start the motor.
	1 On	Automatic start of the motor after switching on the mains voltage if the inverter is enabled and a start command exists.

Related topics

▶ [Start, stop and rotating direction commands](#) 49



5.6 Stop behavior

In the default setting, the motor is brought to a standstill after a stop command with standard ramp. Alternatively, coasting, ramping down with quick stop ramp or a switch-off positioning can be selected.

Details

The stop method can be selected in `0x2838:003 (P203.03)`. The following diagram demonstrates the different stop methods:

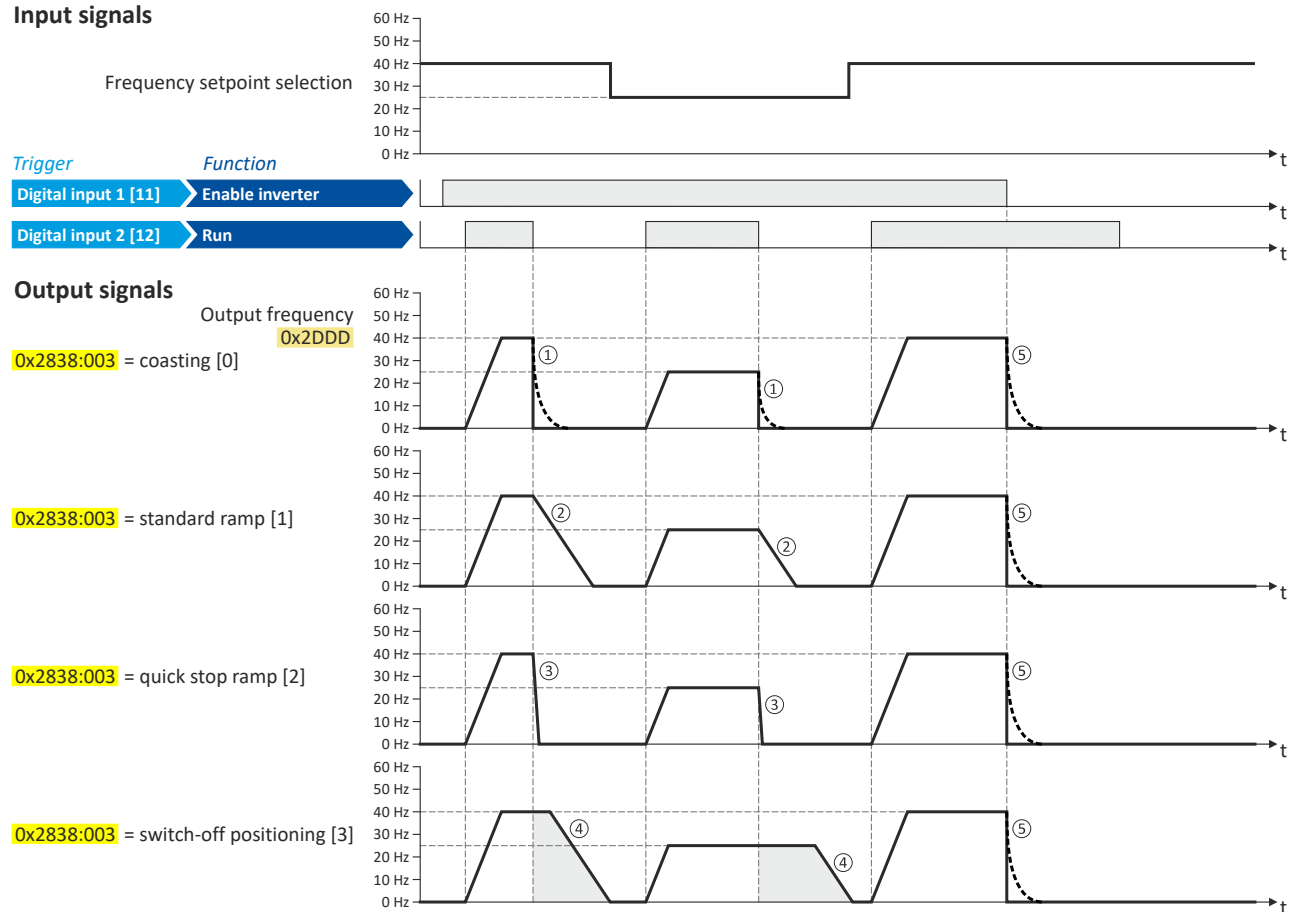

- ① Stop method = "Coasting [0]": The motor coasts down.
- ② Stop method = "Standard ramp [1]": The motor is brought to standstill with a deceleration time 1 (here: 10 s).
- ③ Stop method = "Quick stop ramp [2]": The motor is brought to a standstill with the deceleration time for quick stop (here: 1 s).
- ④ Stop method = "Switch-off positioning [3]": this method is similar to the stop method "Standard ramp". Depending on the current output frequency, however, the inverter delays the beginning of the down-ramping so that the number of motor revolutions until a standstill is reached and thus the stopping position is always relatively constant.
- ⑤ If "Enable inverter" is set to FALSE, the inverter is disabled. The motor has no torque and coasts to standstill depending on the mass inertia of the machine (irrespective of the set stop method).



Parameter

Address	Name / setting range / [default setting]	Information
0x2838:003 (P203.03)	Start/stop configuration: Stop method (Start/stop config: Stop method)	Response after stop command.
	0 Coasting	The motor has no torque (coasts down to standstill).
	1 Standard ramp	The motor is brought to a standstill with deceleration time 1 (or deceleration time 2, if activated). <ul style="list-style-type: none"> Deceleration time 1 can be set in 0x2918 (P221.00). Deceleration time 2 can be set in 0x291A (P223.00). ▶ Ramp times □ 80
	2 Quick stop ramp	The motor is brought to a standstill with the deceleration time set for the "Quick stop" function. <ul style="list-style-type: none"> Deceleration time for quick stop can be set in 0x291C (P225.00). The "quick stop" function can also be activated manually, for instance via a digital input. ▶ Flexible I/O configuration of the start, stop and rotating direction commands □ 54
	3 Switch-off positioning (from version 05.01)	Is similar to the stop method "Standard ramp [1]". Depending on the current output frequency, however, the inverter delays the beginning of the down-ramping so that the number of motor revolutions until a standstill and thus the stopping position is always relatively constant. <ul style="list-style-type: none"> ▶ "Switch-off positioning" stop mode □ 141

Basic setting

Function assignment of the inputs and outputs (default setting)



5.7 Function assignment of the inputs and outputs (default setting)

By default, the inverter can be controlled via the I/O terminals as follows:

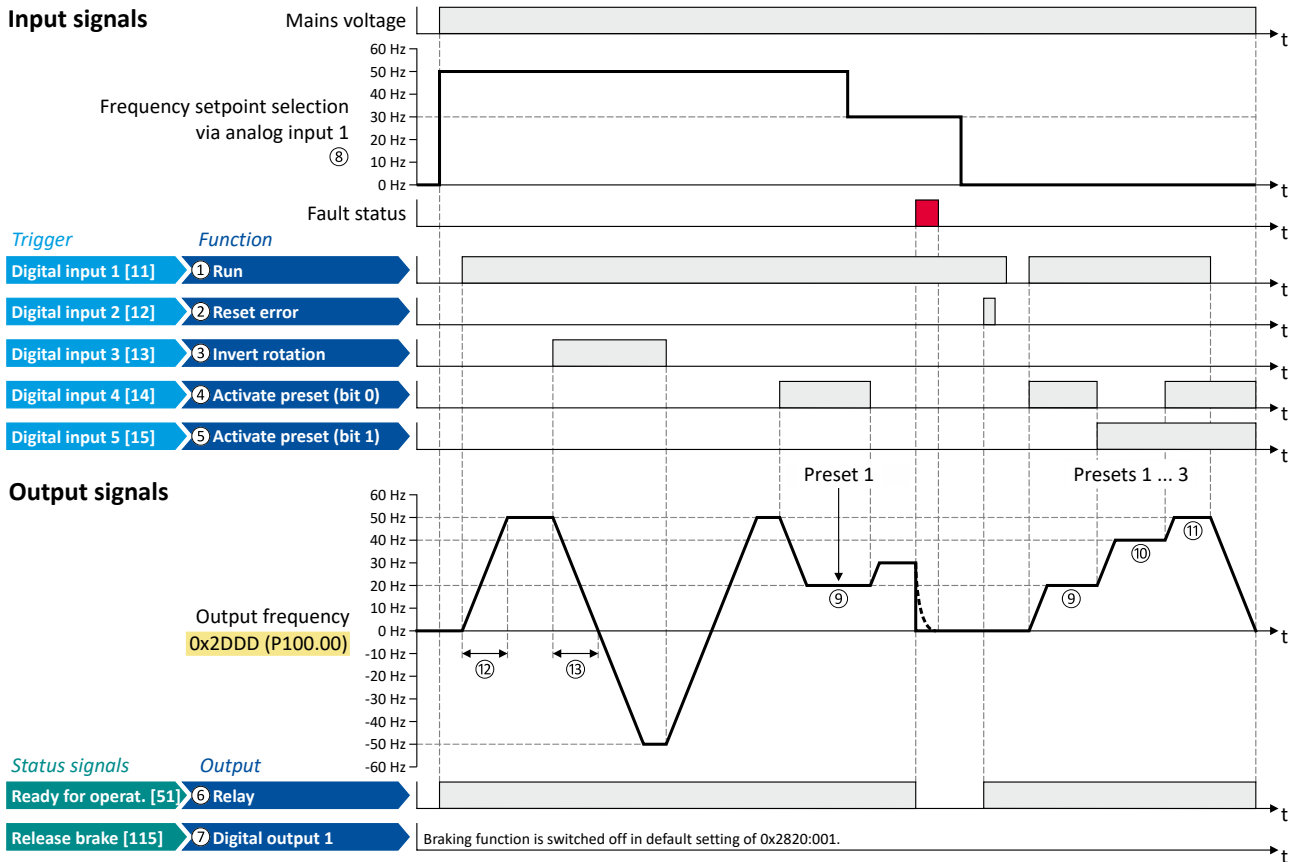

Parameter	Designation	Default setting
Control functions		
① 0x2631:002 (P400.02)	Run	Digital input 1 [11]
② 0x2631:004 (P400.04)	Reset fault	Digital input 2 [12]
③ 0x2631:013 (P400.13)	Reverse rotational direction	Digital input 3 [13]
④ 0x2631:018 (P400.18)	Activate preset (bit 0)	Digital input 4 [14]
⑤ 0x2631:019 (P400.19)	Activate preset (bit 1)	Digital input 5 [15]
Configuration of digital outputs		
⑥ 0x2634:001 (P420.01)	Relay	Ready for operation [51]
⑦ 0x2634:002 (P420.02)	Digital output 1	Release holding brake [115]
Settings for the frequency setpoint		
⑧ 0x2860:001 (P201.01)	Frequency control: Default setpoint source	Analog input 1 [2]
⑨ 0x2911:001 (P450.01)	Frequency setpoint presets: Preset 1	20 Hz
⑩ 0x2911:002 (P450.02)	Frequency setpoint presets: Preset 2	40 Hz
⑪ 0x2911:003 (P450.03)	Frequency setpoint presets: Preset 3	50 Hz
⑫ 0x2917 (P220.00)	Acceleration time 1	5.0 s
⑬ 0x2918 (P221.00)	Deceleration time 1	5.0 s

All functional possible settings for controlling the inverter are described in the "Start, stop and rotating direction commands" chapter. [49](#)



5.8 Motor data

The term "motor data" comprises all parameters only depending on the motor and only characterising the electrical behaviour of the motor. Motor data are independent of the application in which the inverter and the motor are used.

Preconditions

The equivalent circuit data ("Settings" tab, path: "Basic setting\motor", parameterisation dialog "Derived motor properties and equivalent circuit") apply to a motor in star connection. In case of a motor in delta connection, the delta values must be converted into equivalent star values.

Possible settings

If a Lenze motor is connected to the inverter, you can select the motor in the engineering tool from the "motor catalogue".

- For details see chapter "[Select motor from motor catalog](#)". [📖 46](#)

Otherwise the motor data must be set manually (for details see chapter "[Manual setting of the motor data](#)"). [📖 47](#)

Basic setting

Motor data

Select motor from motor catalog



5.8.1 Select motor from motor catalog

The following describes how to parameterise your drive system by selecting a Lenze motor from the motor catalogue. Several processes are started invisibly in the background to load/calculate the settings for the relevant parameters.

Preconditions

- Access to a Lenze engineering tool (e. g. »EASY Starter«).
- Parameters can be set online or offline (with or without connected motor).

Required steps

1. Open the Lenze engineering tool that provides for the functionality of a "Motor catalog".
2. Click the **Select motor...** button. In case of the »EASY Starter«, you find the **Select motor...** button on the "settings". tab.
3. Select the motor used in the "Select motor" dialog:

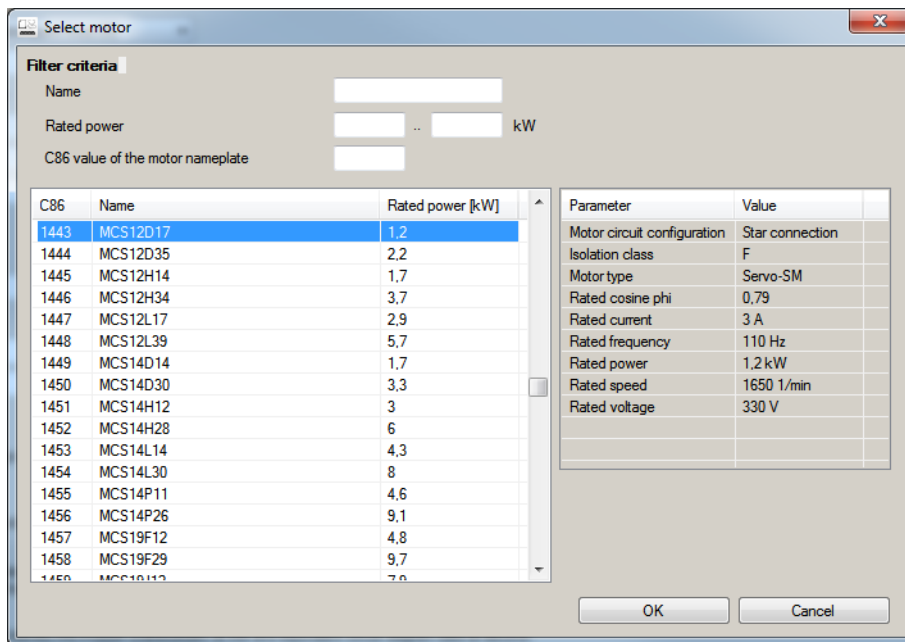

By entering filter criteria, you can restrict the selection.

Name (e. g. "MCS..."), rated power and C86 value can be found on the motor nameplate.

4. Press the **Please select** button to select the thermal sensor.

This is not required for all motors. For older motors, such as MDSKA056-22 (C86=10), a thermal sensor **CANNOT** be selected.



Observe the notes on the ? button.

5. Click the **OK** button to start the optimisation.



Parameterisation sequence

As soon as the parameterisation has been started, the following steps are initiated by the engineering tool:

1. The motor rating data and the motor equivalent circuit diagram data are loaded from the motor catalogue.
2. The motor controller settings and the speed controller settings are automatically calculated based on the previously loaded data.

Notes:

- The data involved in this parameterisation are provided by the motor catalog alone. Further user data is not required.
- The inverter characteristic is not changed by this optimisation.

Parameter

Address	Name / setting range / [default setting]	Information
0x2C01:010	Motor parameters: Motor name	The name (e.g. " 1") can be freely selected by the user. If the motor in the engineering tool has been selected from the "motor catalog", the respective motor name is automatically entered here (example: "MDSKA080-22, 70").

5.8.2 Manual setting of the motor data

Manually set the motor data in accordance with the manufacturer's information / motor data sheet in the following parameters, provided that a third party motor is connected to the inverter.

Parameter

Address	Name / setting range / [default setting]	Information
0x2910:001 (P335.01)	Inertia settings: Motor moment of inertia (Moment of inert.: Motor inertia) 0.00 ... [3.70]* ... 20000000.00 kg cm ² * Default setting dependent on the model.	Setting of the moment of inertia of the motor, relating to the motor.
0x2C01:001	Motor parameters: Number of pole pairs • Read only	Display of the number of pole pairs calculated from the rated speed and rated frequency.
0x2C01:002	Motor parameters: Stator resistance 0.0000 ... [10.1565]* ... 125.0000 Ω * Default setting dependent on the model.	General motor data. Carry out settings as specified by manufacturer data/motor data sheet.
0x2C01:003	Motor parameters: Stator leakage inductance 0.000 ... [23.566]* ... 500.000 mH * Default setting dependent on the model.	Note! When you enter the motor nameplate data, take into account the phase connection implemented for the motor (star or delta connection). Only enter the data applying to the connection type selected.
0x2C01:004 (P320.04)	Motor parameters: Rated speed (Motor parameters: Rated speed) Device for 50-Hz mains: 50 ... [1450] ... 50000 rpm Device for 60-Hz mains: 50 ... [1750] ... 50000 rpm	General motor data. Carry out settings as specified by motor nameplate data.
0x2C01:005 (P320.05)	Motor parameters: Rated frequency (Motor parameters: Rated frequency) Device for 50-Hz mains: 1.0 ... [50.0] ... 1000.0 Hz Device for 60-Hz mains: 1.0 ... [60.0] ... 1000.0 Hz	Note! When you enter the motor nameplate data, take into account the phase connection implemented for the motor (star or delta connection). Only enter the data applying to the connection type selected.
0x2C01:006 (P320.06)	Motor parameters: Rated power (Motor parameters: Rated power) 0.00 ... [0.25]* ... 655.35 kW * Default setting dependent on the model.	
0x2C01:007 (P320.07)	Motor parameters: Rated voltage (Motor parameters: Rated voltage) 0 ... [230]* ... 65535 V * Default setting dependent on the model.	
0x2C01:008 (P320.08)	Motor parameters: Cosine phi (Motor parameters: Cosine phi) 0.00 ... [0.80] ... 1.00	
0x2C02:003 (P351.03)	Motor parameter (ASM): Magnetising current (ASM motor par.: Magn. current) 0.00 ... [0.96]* ... 500.00 A * Default setting dependent on the model.	Equivalent circuit data required for the motor model of the asynchronous machine.

Basic setting

Motor control mode

Manual setting of the motor data



Address	Name / setting range / [default setting]	Information
0x2C03:001 (P352.01)	Motor parameter (PSM): Back EMF constant (PSM motor par.: BEMF constant) 0.0 ... [41.8] ... 100000.0 V/1000rpm • From version 02.00	Voltage induced by the motor (rotor voltage / 1000 rpm). For permanently excited synchronous motors, the e.m.f. constant describes the r.m.s. value of the line-to-line voltage (phase voltage) induced in idle state by the motor (reference: 1000 rpm, 20 °C). Measured: Line to Line (L - L)
0x6075 (P323.00)	Rated motor current (Rated mot.curr.) 0.001 ... [1.700]* ... 500.000 A * Default setting dependent on the model. • Setting can only be changed if the inverter is disabled.	The rated motor current that needs to be set here serves as a reference value for different parameters that involve a setting for/display of a current value in percent. Example: • Rated motor current = 1.7 A • Max. current 0x6073 (P324.00) = 200 % Rated motor current = 3.4 A
0x6076 (P325.00)	Rated motor torque (Rated mot torque) 0.001 ... [1.650]* ... 4294967.295 Nm * Default setting dependent on the model. • Setting can only be changed if the inverter is disabled.	The rated motor torque to be set here serves as a reference value for different parameters with a setting/display of a torque value in percent. Example: • Rated motor torque = 1.65 Nm • Max. torque 0x6072 (P326.00) = 250 % Rated motor torque = 4.125 Nm
0x6080 (P322.00)	Max. motor speed (Max. motor speed) 0 ... [6075] ... 480000 rpm	Limitation of the max. motor speed. Depending on the parameter setting of 0x2D44:001 (P350.01) (Overspeed monitoring: threshold), the speed limitation (0x6080 / Max. motor speed) may become active before speed monitoring.

5.9 Motor control mode

The inverter supports different modes for closed-loop/open-loop motor control.

Parameter

Address	Name / setting range / [default setting]	Information
0x2C00 (P300.00)	Motor control mode (Motor ctrl mode) • Setting can only be changed if the inverter is disabled.	Selection of the motor control type.
	3 Sensorless control (SL PSM) (from version 02.00)	This control type is used for the sensorless control of a synchronous motor. ▶ Sensorless control for synchronous motor (SL-PSM) □ 162
	4 Sensorless vector control (SLVC)	This control type is used for sensorless vector control of an asynchronous motor. ▶ Sensorless vector control (SLVC) □ 165
	6 V/f characteristic control (VFC open loop)	This control mode is used for the speed control of an asynchronous motor via a V/f characteristic and is the simplest control mode. ▶ V/f characteristic control for asynchronous motor (VFC open loop) □ 167
	8 Sensorless control for synchronous motors (SLSM-PSM) (from version 05.05)	This control type is used for the sensorless control of a synchronous motor. Compared to the sensorless "SL-PSM" control, the "SLSM-PSM" control offers the following advantages: • Lower power consumption and more torque through HF injection in the lower speed range • Easier commissioning due to support for automatic identification of the motor ▶ Sensorless control for synchronous motor (SLSM-PSM) □ 185

The detailed description of each motor control type can be found in the chapter "[Configuring the motor control](#)". [□ 160](#)



6 Start, stop and rotating direction commands

6.1 Control selection

The selected "control source" serves to provide the inverter with its start, stop, and reversal commands.

Possible control sources:

- Digital inputs
- Keypad
- Network

The following signal flow shows the internal control logics:

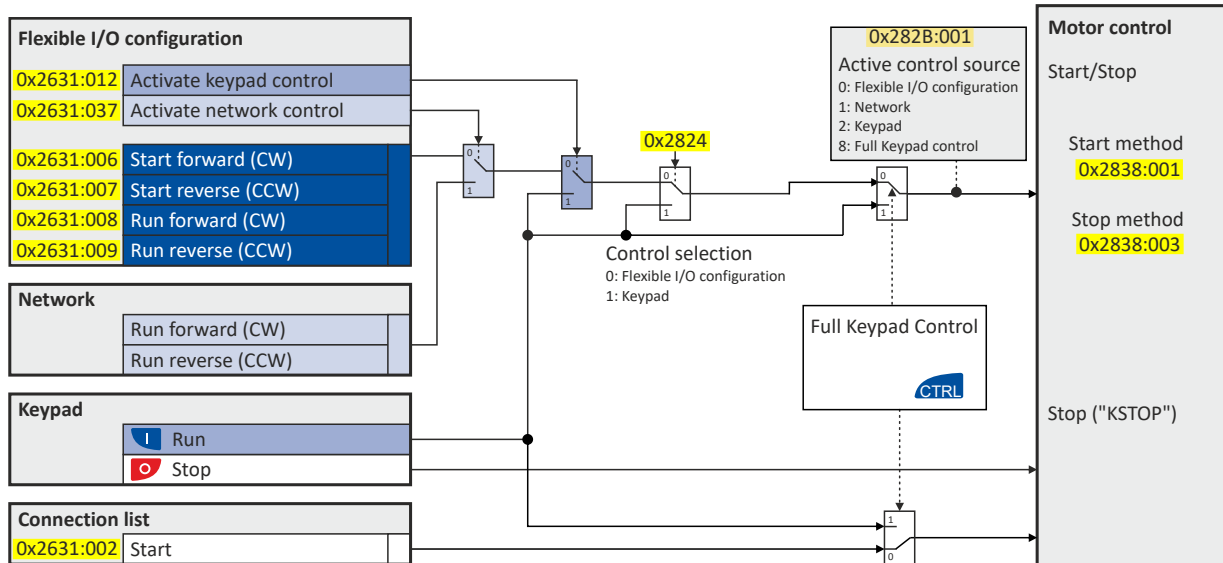

NOTICE

Stop commands are always active from any connected source, regardless of which control source is selected!

If, for example, the network control is activated and a keypad is plugged in for diagnostic purposes, the motor is also stopped when the  keypad key is pressed.

► **Exception:** A stop command has no effect in jog operation.

Start, stop and rotating direction commands

Control selection



In order to control the inverter from the network, the network share [0x2631:037 \(P400.37\)](#) must be configured.

In case of an activated network control, the following functions are still active:

- [0x2631:001 \(P400.01\)](#): Enable inverter
- [0x2631:002 \(P400.02\)](#): Run
- [0x2631:003 \(P400.03\)](#): Activate quick stop
- [0x2631:004 \(P400.04\)](#): Reset error
- [0x2631:005 \(P400.05\)](#): DC braking
- [0x2631:010 \(P400.10\)](#): Jog forward (CW)
- [0x2631:011 \(P400.11\)](#): Jog reverse (CCW)*
- [0x2631:012 \(P400.12\)](#): Activate keypad control*
- [0x2631:037 \(P400.37\)](#): Activate network control*
- [0x2631:043 \(P400.43\)](#): Activate fault 1
- [0x2631:044 \(P400.44\)](#): Activate fault 2
- [0x2631:054 \(P400.54\)](#): Reset position counter

(*Not active in case of network operation in CiA402 mode).

In case of an activated network control, the following functions are also still active if they are not configured in the NetWordIN1 bit functionality:



- [0x2631:048 \(P400.48\)](#): Activate PID influence ramp
- [0x2631:041 \(P400.41\)](#): Select parameter set (bit 0)
- [0x2631:042 \(P400.42\)](#): Select parameter set (bit 1)

All other functions configurable via [0x2631:xx \(P400.xx\)](#) are deactivated in case of network control.

Details

- The default setting "Flexible I/O configuration [0]" in [0x2824 \(P200.00\)](#) enables a flexible control of the inverter via digital inputs, network and keypad. The control of the inverter via the digital inputs is preconfigured. For details see the subchapter "[Flexible I/O configuration](#)". [51](#)
- For details of the network control of the inverter, see the chapter "[Control the inverter via network](#)". [258](#)
- If the keypad is to be used as the control source for the application, set "Keypad [1]" in [0x2824 \(P200.00\)](#). For details, see subchapter "[Keypad control](#)". [52](#)
- The control source that is currently active is displayed in [0x282B:001 \(P125.01\)](#).

Parameter

Address	Name / setting range / [default setting]	Information
0x2824 (P200.00)	Control selection (Control select.)	Selection of the type of inverter control.
	0 Flexible I/O configuration	This selection enables a flexible assignment of the start, stop, and rotating direction commands with digital signal sources. <ul style="list-style-type: none"> • Digital signal sources can be digital inputs, network and keypad. • The I/O configuration is made via the parameters 0x2631:xx (P400.xx).
	1 Keypad	This selection enables the motor to be started exclusively via the start key of the keypad. Other signal sources for starting the motor are ignored. <div style="display: flex; align-items: center; gap: 10px;">  Start motor  Stop motor </div> <p>Note!</p> <ul style="list-style-type: none"> • The functions "Enable inverter" 0x2631:001 (P400.01) and "Run" 0x2631:002 (P400.02) must be set to TRUE to start the motor. • If jog operation is active, the motor cannot be stopped via the  keypad key.



6.1.1 Flexible I/O configuration

Use parameters 0x2631:xx (P400.xx) to individually adapt the inverter control to the respective application. This is basically effected by assigning digital control sources ("triggers") to functions of the inverter.

NOTICE

A digital signal source can be assigned to several functions.

Possible consequence: unforeseeable behaviour of the drive in case of incorrect assignment

► Carry out assignment of a digital signal source to several functions with greater care.

Details

- The flexible I/O configuration is active if the selection "Flexible I/O configuration [0]" (default) is set in 0x2824 (P200.00).
- Each subcode of 0x2631 (P400) is permanently assigned to a specific function. Functions are for example "Enable inverter", "Activate quick stop" or "Start forward (CW)".
- For a function, exactly one (digital) trigger can be set:



- Possible triggers to be selected are for example the digital input and internal status signals of the inverter.
- A list of all available triggers can be found in the "Trigger list". [59](#)
- The corresponding function is executed if the trigger condition is fulfilled.

Example: changing the function assignment of a digital input

Task for this example:

1. The preset assignment of the digital input 3 for the function "Reverse rotational direction" is to be cancelled.
2. Instead, the digital input 3 is to be assigned to the "Activate DC braking" function.

For this purpose, the following two settings are required:

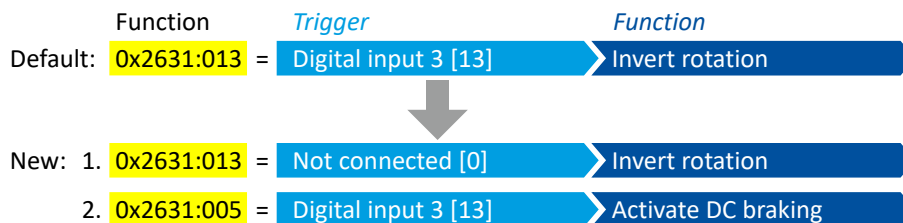

Related topics

- Flexible I/O configuration of the start, stop and rotating direction commands [54](#)

Start, stop and rotating direction commands

Control selection
Keypad control



6.1.2 Keypad control

The "Keypad" control selection enables the motor to be started exclusively via the start key of the keypad. Other signal sources for starting the motor are ignored.

Details

If the keypad is to be used as the sole control source for the application, set [0x2824 \(P200.00\)](#) to "Keypad [1]".

If the local keypad control is active, "LOC" is displayed in the lower status row of the keypad. The keys on the keypad then have the following function:

Function of keypad keys in operating mode			
Key	Actuation	Condition	Action
	Briefly	Local keypad control active. Display "LOC"	Run motor.
	Briefly	No Jog operation	Stop motor. Display "KSTOP"
	Briefly	Operating mode	Change to parameterization mode. ▶ Keypad parameterisation mode 403
	Longer than 3 s	None (anytime possible)	Save parameter settings in the user memory of the memory module.
	Briefly	During operation	Scroll through information in the above status line.
	Briefly	Operating mode	Activate full keypad control. Display "ON?" → Confirm with Control and setpoint selection can now only be carried out via keypad. Renewed clicking: Exit full keypad control. Display "OFF?" → Confirm with ▶ Keypad full control 53
	Briefly	Local keypad control active. Display "LOC"	Reversal of rotation direction. Display "REV?" → Confirm with ▶ Configure R/F and CTRL keys 426

• In case of keypad control, the following functions continue to be active:

- [0x2631:001 \(P400.01\)](#): Enable inverter
- [0x2631:003 \(P400.03\)](#): Activate quick stop
- [0x2631:004 \(P400.04\)](#): Reset fault
- [0x2631:005 \(P400.05\)](#): Activate DC braking
- [0x2631:010 \(P400.10\)](#): Jog forward (CW)
- [0x2631:011 \(P400.11\)](#): Jog reverse (CCW)
- All other functions of [0x2631:012 \(P400.12\)](#) - [0x2631:055 \(P400.55\)](#)

Related topics

▶ [Keypad](#) [399](#)



Start, stop and rotating direction commands

Control selection
Keypad full control

6.1.3 Keypad full control

The "Keypad Full Control" control mode can be activated with the keypad key "CTRL". Both the control and the setpoint selection are then made via the keypad. This special control mode can be, for instance, used during the commissioning phase if external control and setpoint sources are not ready to use yet.



⚠ CAUTION!

If the "Keypad Full Control" control mode is active, the "Run" 0x2631:002 (P400.02) function is internally set to TRUE.

In this case, the motor cannot be stopped via this function.

- ▶ For stopping the motor, use the  keypad key, deactivate the inverter enable or activate the "quick stop" function.

Details

- After the "CTRL" key has been pressed, the activation of the control mode must be confirmed with the  key. (The  key serves to cancel the action.)
- When the control mode is changed over, the motor is first stopped and the "Forward" direction of rotation is set. Then, the motor can be started and stopped via the keypad.

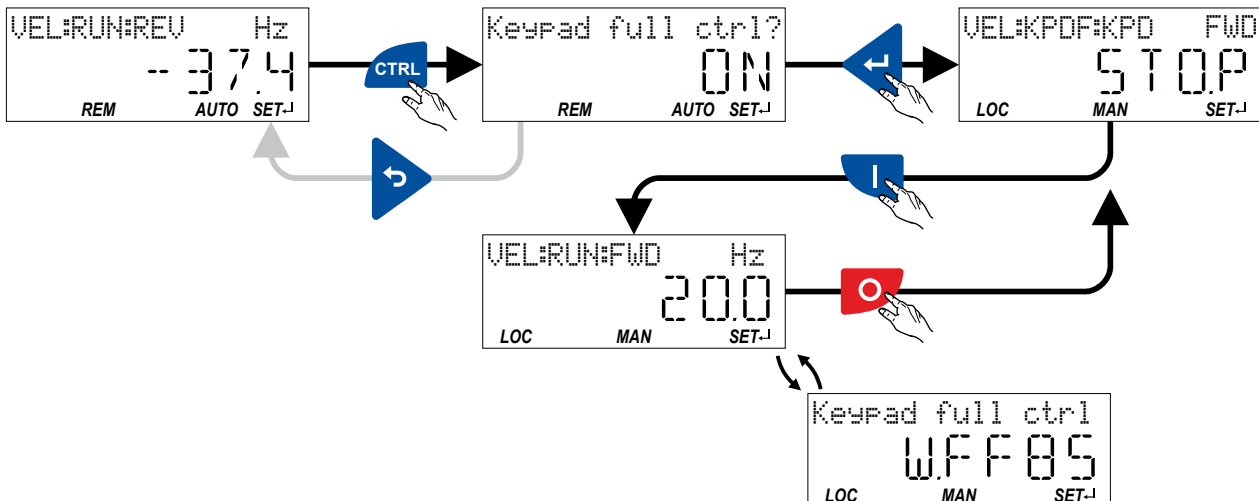

If the "Keypad Full Control" control mode is active,

- the keypad shows the warning "Keypad full ctrl" alternately with the status display.
- the set standard setpoint sources are ignored.
- a changeover to other setpoint sources is not possible.
- a changeover to network control is not possible.

In case of keypad control, the following functions continue to be active:

- 0x2631:001 (P400.01): Enable inverter
- 0x2631:003 (P400.03): Activate quick stop
- 0x2631:004 (P400.04): Reset fault
- 0x2631:005 (P400.05): Activate DC braking
- 0x2631:010 (P400.10): Jog forward (CW)
- 0x2631:011 (P400.11): Jog reverse (CCW)
- All other functions of 0x2631:012 (P400.12) - 0x2631:055 (P400.55)

The control mode can be terminated again if the "CTRL" keypad key is pressed again.

Related topics

- ▶ [Configure R/F and CTRL keys](#)  426

Start, stop and rotating direction commands

Flexible I/O configuration of the start, stop and rotating direction commands



6.2 Flexible I/O configuration of the start, stop and rotating direction commands

Configuration of the triggers for the basic functions for controlling the motor.

Details

The following table contains a short overview of the basic functions. For more details see the following parameter descriptions.

Function	Info
Enable inverter 0x2631:001 (P400.01)	<p>Enable/disable operation.</p> <ul style="list-style-type: none"> The function must be set to TRUE to start the motor. Either via a digital input or the default setting "Constant TRUE [1]". If the function is set to FALSE, the inverter is disabled. The motor has no torque (coasts). <p>▶ Example: Enable inverter 68</p>
Run 0x2631:002 (P400.02)	<p>Function 1: Start / stop motor (default setting)</p> <ul style="list-style-type: none"> Function 1 is active if no further start commands (start forward/start reverse) have been connected to triggers, no keypad control is active and no network control is active. <p>TRUE: Let motor rotate forward (CW). FALSE: Stop the motor.</p> <p>▶ Example: Start/stop (1 signal) and reversal 62</p> <p>Function 2: Start enable/stop motor</p> <ul style="list-style-type: none"> Function 2 is active if further start commands have been connected to triggers, the keypad control is active or the network control is active. <p>TRUE: Start commands of the active control source are enabled. FALSE: Stop the motor.</p> <p>▶ Example: Start forward/start reverse/stop (edge-controlled) 63 ▶ Example: Run forward/Run reverse/stop (status-controlled) 65</p>
Activate quick stop 0x2631:003 (P400.03)	<p>Bring the motor to a standstill in best time.</p> <p>▶ Example: Quick stop 67</p>
Start forward (CW) 0x2631:006 (P400.06)	<p>Start the motor edge-controlled.</p> <ul style="list-style-type: none"> In order to be able to start the motor, the "Run" function must be set to TRUE. The motor is stopped by resetting the "Run" function to FALSE. The functions are deactivated in case of keypad or network control. <p>▶ Example: Start forward/start reverse/stop (edge-controlled) 63</p>
Start reverse (CCW) 0x2631:007 (P400.07)	
Run forward (CW) 0x2631:008 (P400.08)	<p>Let the motor rotate in a status-controlled way.</p> <ul style="list-style-type: none"> In order to be able to start the motor, the "Run" function must be set to TRUE. The functions are deactivated in the case of keypad or network control. <p>▶ Example: Run forward/Run reverse/stop (status-controlled) 65</p>
Run reverse (CCW) 0x2631:009 (P400.09)	
Jog forward (CW) 0x2631:010 (P400.10)	<p>Jog operation: Let the motor rotate in a status-controlled way with setpoint preset.</p> <p>⚠ CAUTION!</p> <p>The jog operation has a higher priority than the "Run" function, all other start commands and the keypad key .</p> <ul style="list-style-type: none"> If the jog operation is active, the motor cannot be stopped with the previously mentioned functions! However, jog operation can be interrupted by the "Quick stop" function. Jog operation can always be activated, even in case of keypad or network control. <p>▶ Example: Jog forward/Jog reverse 69</p>
Jog reverse (CCW) 0x2631:011 (P400.11)	
Reverse rotational direction 0x2631:013 (P400.13)	<p>Invert the frequency setpoint.</p> <ul style="list-style-type: none"> The function can be used in combination with all start commands. The function is deactivated in the case of network control. <p>▶ Example: Start/stop (1 signal) and reversal 62</p>

Assignment guidelines

The error message "Trigger/functions connected incorrectly" (error code 25216 | 0x6280) is output if one of the following assignment guidelines is not observed:

- If the "flexible I/O configuration" is active as control source, the "Enable inverter" or "Run" function must be connected to a digital input in order that the motor can be stopped again any time!
- With keypad or network control, the two functions "Enable inverter" and "Run" can also be set to "Constant TRUE [1]" to start the motor.
- The use of the "Start forward (CW)" and "Start reverse (CCW)" functions excludes the use of the "Run forward (CW)" and "Run reverse (CCW)" functions, and vice versa.



Start, stop and rotating direction commands

Flexible I/O configuration of the start, stop and rotating direction commands

Parameter

Address	Name / setting range / [default setting]	Information
0x2631:001 (P400.01)	Function list: Enable inverter (Function list: Enable inverter) <ul style="list-style-type: none"> Setting can only be changed if the inverter is disabled. Further possible settings: ▶ Trigger list □ 59 	Assignment of a trigger for the "Enable inverter" function. Trigger = TRUE: The inverter is enabled (unless there is another cause for inverter disable). Trigger = FALSE: The inverter is disabled. Notes: <ul style="list-style-type: none"> This function must be set to TRUE to start the motor. The signal TRUE is activated either via an assigned digital input or the default setting "Constant TRUE [1]". Changing to the inhibited state causes an immediate stop of the motor, regardless of the stop method set in 0x2838:003 (P203.03). The motor has no torque and coasts down. The cause(s) for the inhibited state are shown in 0x282A:001 (P126.01). ▶ Example: Enable inverter □ 68
	1 Constant TRUE	Trigger is constantly TRUE.
0x2631:002 (P400.02)	Function list: Run (Function list: Run) <ul style="list-style-type: none"> Setting can only be changed if the inverter is disabled. Further possible settings: ▶ Trigger list □ 59 	Assignment of a trigger to the "Run" function. Function 1: Start / stop motor (default setting) Function 1 is active if no further starting commands (start forward/start reverse) have been connected to triggers, no keypad control is active and no network control is active. Trigger = TRUE: Let motor rotate forward (CW). Trigger = FALSE: Stop motor. Notes to function 1: <ul style="list-style-type: none"> If "Enable inverter" 0x2631:001 (P400.01) is set = "Constant TRUE [1]", the only permissible trigger for this function is a digital input in order that the motor can be stopped again any time. The stop method can be selected in 0x2838:003 (P203.03). The function also serves to realize an automatic start after switch-on. ▶ Start behavior □ 39 ▶ Example: Start/stop (1 signal) and reversal □ 62 Function 2: Start enable/stop motor Function 2 is active if further starting commands have been connected to triggers, keypad control is active or network control is active. Trigger = TRUE: Startbefehle der aktiven Steuerquelle sind freigeben. Trigger = FALSE: Stop motor. Notes to function 2: <ul style="list-style-type: none"> If no separate start enable is required for the application, the trigger "Constant TRUE [1]" must be set. The stop method can be selected in 0x2838:003 (P203.03). ▶ Example: Start forward/start reverse/stop (edge-controlled) □ 63 ▶ Example: Run forward/Run reverse/stop (status-controlled) □ 65
	11 Digital input 1	State of X3/DI1, taking an inversion set in 0x2632:001 (P411.01) into consideration.
	0x2631:003 (P400.03)	Function list: Activate quick stop (Function list: Quick stop) <ul style="list-style-type: none"> Setting can only be changed if the inverter is disabled. Further possible settings: ▶ Trigger list □ 59
0 Not connected	No trigger assigned (trigger is constantly FALSE).	

Start, stop and rotating direction commands

Flexible I/O configuration of the start, stop and rotating direction commands



Address	Name / setting range / [default setting]	Information
0x2631:006 (P400.06)	Function list: Start forward (CW) (Function list: Start forward) <ul style="list-style-type: none"> Setting can only be changed if the inverter is disabled. Further possible settings: ▶ Trigger list □ 59 	Assignment of a trigger for the "Start forward (CW)" function. Trigger = FALSE↗TRUE (edge): Let motor rotate forward. Trigger = TRUE↘FALSE (edge): No action. Notes: <ul style="list-style-type: none"> In order to start the motor, "Enable inverter" 0x2631:001 (P400.01) and "Run" 0x2631:002 (P400.02) must be set to TRUE. After the start, the motor runs until "Run" is set to FALSE, another stop command is given or the inverter is disabled. In the case of a bipolar setpoint selection (e.g. ±10 V), the function is executed independent of the direction of rotation. The rotating direction is determined by the sign of the setpoint. ▶ Example: Start forward/start reverse/stop (edge-controlled) □ 63
	0 Not connected	No trigger assigned (trigger is constantly FALSE).
0x2631:007 (P400.07)	Function list: Start reverse (CCW) (Function list: Start reverse) <ul style="list-style-type: none"> Setting can only be changed if the inverter is disabled. Further possible settings: ▶ Trigger list □ 59 	Assignment of a trigger for the "Start reverse (CCW)" function Trigger = FALSE↗TRUE (edge): Let motor rotate backward. Trigger = TRUE↘FALSE (edge): No action. Notes: <ul style="list-style-type: none"> In order to start the motor, "Enable inverter" 0x2631:001 (P400.01) and "Run" 0x2631:002 (P400.02) must be set to TRUE. After the start, the motor runs until "Run" is set to FALSE, another stop command is given or the inverter is disabled. In the case of a bipolar setpoint selection (e.g. ±10 V), the function is executed independent of the direction of rotation. The rotating direction is determined by the sign of the setpoint. ▶ Example: Start forward/start reverse/stop (edge-controlled) □ 63
	0 Not connected	No trigger assigned (trigger is constantly FALSE).
0x2631:008 (P400.08)	Function list: Run forward (CW) (Function list: Run forward) <ul style="list-style-type: none"> Setting can only be changed if the inverter is disabled. Further possible settings: ▶ Trigger list □ 59 	Assignment of a trigger for the "Run forward (CW)" function. Trigger = TRUE: Let motor rotate forward. Trigger = FALSE: Stop motor. Notes: <ul style="list-style-type: none"> In order to start the motor, "Enable inverter" 0x2631:001 (P400.01) and "Run" 0x2631:002 (P400.02) must be set to TRUE. The inverter always responds to the run command detected last. A start enable must exist. The stop method can be selected in 0x2838:003 (P203.03). In the case of a bipolar setpoint selection (e.g. ±10 V), the function is executed independent of the direction of rotation. The rotating direction is determined by the sign of the setpoint. The "Run forward (CW)" function also serves to realise an automatic start after switch-on. ▶ Start behavior □ 39 ▶ Example: Run forward/Run reverse/stop (status-controlled) □ 65
	0 Not connected	No trigger assigned (trigger is constantly FALSE).
0x2631:009 (P400.09)	Function list: Run reverse (CCW) (Function list: Run reverse) <ul style="list-style-type: none"> Setting can only be changed if the inverter is disabled. Further possible settings: ▶ Trigger list □ 59 	Assignment of a trigger for the "Run reverse (CCW)" function. Trigger = TRUE: Let motor rotate backward. Trigger = FALSE: Stop motor. Notes: <ul style="list-style-type: none"> In order to start the motor, "Enable inverter" 0x2631:001 (P400.01) and "Run" 0x2631:002 (P400.02) must be set to TRUE. The inverter always responds to the run command detected last. A start enable must exist. The stop method can be selected in 0x2838:003 (P203.03). In the case of a bipolar setpoint selection (e.g. ±10 V), the function is executed independent of the direction of rotation. The rotating direction is determined by the sign of the setpoint. The "Run reverse (CCW)" function also serves to realise an automatic start after switch-on. ▶ Start behavior □ 39 ▶ Example: Run forward/Run reverse/stop (status-controlled) □ 65
	0 Not connected	No trigger assigned (trigger is constantly FALSE).



Start, stop and rotating direction commands

Flexible I/O configuration of the start, stop and rotating direction commands

Address	Name / setting range / [default setting]	Information
0x2631:010 (P400.10)	Function list: Jog forward (CW) (Function list: Jog forward) <ul style="list-style-type: none"> Setting can only be changed if the inverter is disabled. 	Assignment of a trigger for the "Jog forward (CW)" function. Trigger = TRUE: Let motor rotate forward with preset 5. Trigger = FALSE: Stop motor. ⚠ CAUTION! The jog operation has a higher priority than the "Run" function, all other start commands and the keypad key . <ul style="list-style-type: none"> If jog operation is active, the motor cannot be stopped with the previously mentioned functions! However, jog operation can be interrupted by the "Quick stop" function. Notes: <ul style="list-style-type: none"> The preset 5 can be set in 0x2911:005 (P450.05). The stop method can be selected in 0x2838:003 (P203.03). If "Jog forward (CW)" and "Jog reverse (CCW)" are activated at the same time, the motor is stopped using the set stop method and jog operation must be triggered again. Jog operation cannot be started automatically. The "Start at power-up" option in 0x2838:002 (P203.02) does not apply to jog operation. ▶ Example: Jog forward/Jog reverse 69
0	Not connected	No trigger assigned (trigger is constantly FALSE).
11	Digital input 1	State of X3/DI1, taking an inversion set in 0x2632:001 (P411.01) into consideration.
12	Digital input 2	State of X3/DI2, taking an inversion set in 0x2632:002 (P411.02) into consideration.
13	Digital input 3	State of X3/DI3, taking an inversion set in 0x2632:003 (P411.03) into consideration.
14	Digital input 4	State of X3/DI4, taking an inversion set in 0x2632:004 (P411.04) into consideration.
15	Digital input 5	State of X3/DI5, taking an inversion set in 0x2632:005 (P411.05) into consideration.
16	Digital input 6	State of X3/DI6, taking an inversion set in 0x2632:006 (P411.06) into consideration.
17	Digital input 7	State of X3/DI7, taking an inversion set in 0x2632:007 (P411.07) into consideration.
50	Running	TRUE if inverter and start are enabled and output frequency > 0 Hz. Otherwise FALSE. Exception, quick stop mode: TRUE if inverter and start are enabled and output frequency > 0.2 Hz. Otherwise FALSE.
51	Ready for operation	TRUE, wenn Inverter betriebsbereit (kein Fehler aktiv und Zwischenkreisspannung ok). Sonst FALSE.
53	Stop active	TRUE if inverter is enabled and motor is not started and output frequency = 0.
54	Quick stop active	TRUE if quick stop is active. Otherwise FALSE.
58	Device warning active	TRUE if warning is active. Otherwise FALSE. <ul style="list-style-type: none"> A warning has no impact on the operating status of the inverter. A warning is reset automatically if the cause has been eliminated.
59	Device trouble active	TRUE if a fault is active. Otherwise FALSE. <ul style="list-style-type: none"> In the event of a fault, the motor is brought to a standstill with the quick stop ramp. The inverter is then disabled. Exception: In case of a serious fault, the inverter is disabled immediately. The motor has no torque (coasts). The error state will be left automatically if the error condition is not active anymore. The restart behaviour after trouble can be configured. ▶ Automatic restart after a fault 361
60	Heatsink temperature warning active	TRUE if current heatsink temperature > warning threshold for temperature monitoring. Otherwise FALSE. <ul style="list-style-type: none"> Display of the current heatsink temperature in 0x2D84:001 (P117.01). Setting of the warning threshold in 0x2D84:002.
68	Stop command active	TRUE if delay to standstill active. Otherwise FALSE.
69	Rotational direction reversed	TRUE if output frequency is negative. Otherwise FALSE.

Start, stop and rotating direction commands

Flexible I/O configuration of the start, stop and rotating direction commands



Address	Name / setting range / [default setting]	Information
70	Frequency threshold exceeded	TRUE if current output frequency > frequency threshold. Otherwise FALSE. <ul style="list-style-type: none"> • Display of the current output frequency in 0x2DDD (P100.00). • Setting Frequency threshold in 0x4005 (P412.00). <p>▶ Trigger action if a frequency threshold is exceeded □ 381</p>
71	Actual speed = 0	TRUE if actual output frequency = 0 Hz (± 0.3 Hz), irrespective of the operating mode. Otherwise FALSE. <ul style="list-style-type: none"> • Display of the current output frequency in 0x2DDD (P100.00).
78	Current limit reached	TRUE if current motor current \geq maximum current. Otherwise FALSE. <ul style="list-style-type: none"> • Display of the present motor current in 0x2D88 (P104.00). • Setting for the maximum current in 0x6073 (P324.00).
79	Torque limit reached (from version 02.00)	TRUE if torque limit has been reached or exceeded. Otherwise FALSE. <ul style="list-style-type: none"> • Setting "Actual positive torque limit" in 0x2949:003 (P337.03). • Setting Actual negative torque limit in 0x2949:004 (P337.04). <p>▶ Motor torque monitoring □ 231</p>
81	Error of analog input 1 active	TRUE if the monitoring of the input signal at the analog input 1 has responded. Otherwise FALSE. This trigger is set as a function of the following settings: <ul style="list-style-type: none"> • Monitoring threshold 0x2636:008 (P430.08) • Monitoring condition 0x2636:009 (P430.09) The setting of the Error response in 0x2636:010 (P430.10) has no effect on this trigger. <p>▶ Analog input 1 □ 240</p>
82	Error of analog input 2 active	TRUE if the monitoring of the input signal at the analog input 2 has responded. Otherwise FALSE. This trigger is set as a function of the following settings: <ul style="list-style-type: none"> • Monitoring threshold 0x2637:008 (P431.08) • Monitoring condition 0x2637:009 (P431.09) The setting of the Error response in 0x2637:010 (P431.10) has no effect on this trigger. <p>▶ Analog input 2 □ 244</p>
83	Load loss detected	TRUE if actual motor current < threshold for load loss detection after delay time of the load loss detection has elapsed. Otherwise FALSE. <ul style="list-style-type: none"> • Display of the actual current in 0x6078 (P103.00). • Setting Threshold in 0x4006:001 (P710.01). • Setting Delay time in 0x4006:002 (P710.02). <p>▶ Load loss detection □ 206</p>
84	Heavy load monitoring	TRUE if the actual apparent current of the motor exceeds the threshold for longer than the delay time. FALSE if the actual apparent current of the motor falls below the threshold value minus 5 % (hysteresis). <p>▶ Heavy load monitoring □ 235</p>
102	Sequence suspended (from version 03.00)	Status signal of the "sequencer" function: TRUE if the sequence is currently suspended. <p>▶ Sequencer □ 87</p>
103	Sequence done (from version 03.00)	Status signal of the "sequencer" function: TRUE if the sequence is completed (final segment has been passed through). <p>▶ Sequencer □ 87</p>
104	Local control active	TRUE if local keypad control ("LOC") active. Otherwise FALSE.
105	Remote control active	TRUE if remote control ("REM") via terminals, network, etc. active. Otherwise FALSE.
106	Manual setpoint selection active	TRUE if manual setpoint selection ("MAN") via keypad active. Otherwise FALSE. <ul style="list-style-type: none"> • Selection of the trigger for the "Activate keypad setpoint" function in 0x2631:016 (P400.16).
107	Automatic setpoint selection active	TRUE if automatic setpoint selection ("AUTO") via terminals, network, etc. active. Otherwise FALSE.

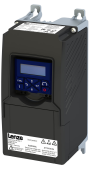

Start, stop and rotating direction commands

Flexible I/O configuration of the start, stop and rotating direction commands
Trigger list

Address	Name / setting range / [default setting]	Information
	201 Internal value (from version 05.00)	Internal values of the manufacturer.
	202 Internal value (from version 05.00)	
	203 Internal value (from version 05.00)	
	204 Internal value (from version 05.00)	
	205 Internal value (from version 05.00)	
	206 Internal value (from version 05.00)	
0x2631:011 (P400.11)	Function list: Jog reverse (CCW) (Function list: Jog reverse) <ul style="list-style-type: none"> Setting can only be changed if the inverter is disabled. For further possible settings, see parameter 0x2631:010 (P400.10). □ 57 	Assignment of a trigger for the "Jog reverse (CCW)" function. Trigger = TRUE: Let motor rotate backward with preset 6. Trigger = FALSE: Stop motor. ⚠ CAUTION! The jog operation has a higher priority than the "Run" function, all other start commands and the keypad key  . <ul style="list-style-type: none"> If jog operation is active, the motor cannot be stopped with the previously mentioned functions! However, jog operation can be interrupted by the "Quick stop" function. Notes: <ul style="list-style-type: none"> The preset 6 can be set in 0x2911:006 (P450.06). The stop method can be selected in 0x2838:003 (P203.03). If "Jog forward (CW)" and "Jog reverse (CCW)" are activated at the same time, the motor is stopped using the set stop method and jog operation must be triggered again. Jog operation cannot be started automatically. The "Start at power-up" option in 0x2838:002 (P203.02) does not apply to jog operation. ▶ Example: Jog forward/Jog reverse □ 69
	0 Not connected	No trigger assigned (trigger is constantly FALSE).
0x2631:013 (P400.13)	Function list: Reverse rotational direction (Function list: Reverse rot.dir.) <ul style="list-style-type: none"> Setting can only be changed if the inverter is disabled. Further possible settings: ▶ Trigger list □ 59 	Assignment of a trigger for the "Reverse rotational direction" function. Trigger = TRUE: the setpoint specified is inverted (i. e. the sign is inverted). Trigger = FALSE: no action / deactivate function again. ▶ Example: Start/stop (1 signal) and reversal □ 62
	13 Digital input 3	State of X3/DI3, taking an inversion set in 0x2632:003 (P411.03) into consideration.

6.2.1 Trigger list

The trigger list lists all selection options (triggers) for the functions which can be configured using the parameters 0x2631:xx (P400.xx).

Selection	Information
0 Not connected	No trigger assigned (trigger is constantly FALSE).
1 Constant TRUE	Trigger is constantly TRUE.
11 Digital input 1	State of X3/DI1, taking an inversion set in 0x2632:001 (P411.01) into consideration.
12 Digital input 2	State of X3/DI2, taking an inversion set in 0x2632:002 (P411.02) into consideration.
13 Digital input 3	State of X3/DI3, taking an inversion set in 0x2632:003 (P411.03) into consideration.
14 Digital input 4	State of X3/DI4, taking an inversion set in 0x2632:004 (P411.04) into consideration.
15 Digital input 5	State of X3/DI5, taking an inversion set in 0x2632:005 (P411.05) into consideration.
16 Digital input 6	State of X3/DI6, taking an inversion set in 0x2632:006 (P411.06) into consideration.
17 Digital input 7	State of X3/DI7, taking an inversion set in 0x2632:007 (P411.07) into consideration.
50 Running	TRUE if inverter and start are enabled and output frequency > 0 Hz. Otherwise FALSE. Exception, quick stop mode: TRUE if inverter and start are enabled and output frequency > 0.2 Hz. Otherwise FALSE.

Start, stop and rotating direction commands

Flexible I/O configuration of the start, stop and rotating direction commands
Trigger list



Selection	Information
51 Ready for operation	TRUE, wenn Inverter betriebsbereit (kein Fehler aktiv und Zwischenkreisspannung ok). Sonst FALSE.
53 Stop active	TRUE if inverter is enabled and motor is not started and output frequency = 0.
54 Quick stop active	TRUE if quick stop is active. Otherwise FALSE.
58 Device warning active	TRUE if warning is active. Otherwise FALSE. <ul style="list-style-type: none"> • A warning has no impact on the operating status of the inverter. • A warning is reset automatically if the cause has been eliminated.
59 Device trouble active	TRUE if a fault is active. Otherwise FALSE. <ul style="list-style-type: none"> • In the event of a fault, the motor is brought to a standstill with the quick stop ramp. The inverter is then disabled. • Exception: In case of a serious fault, the inverter is disabled immediately. The motor has no torque (coasts). • The error state will be left automatically if the error condition is not active anymore. • The restart behaviour after trouble can be configured. ▶ Automatic restart after a fault □ 361
60 Heatsink temperature warning active	TRUE if current heatsink temperature > warning threshold for temperature monitoring. Otherwise FALSE. <ul style="list-style-type: none"> • Display of the current heatsink temperature in 0x2D84:001 (P117.01). • Setting of the warning threshold in 0x2D84:002.
68 Stop command active	TRUE if delay to standstill active. Otherwise FALSE.
69 Rotational direction reversed	TRUE if output frequency is negative. Otherwise FALSE.
70 Frequency threshold exceeded	TRUE if current output frequency > frequency threshold. Otherwise FALSE. <ul style="list-style-type: none"> • Display of the current output frequency in 0x2DDD (P100.00). • Setting Frequency threshold in 0x4005 (P412.00). ▶ Trigger action if a frequency threshold is exceeded □ 381
71 Actual speed = 0	TRUE if actual output frequency = 0 Hz (± 0.3 Hz), irrespective of the operating mode. Otherwise FALSE. <ul style="list-style-type: none"> • Display of the current output frequency in 0x2DDD (P100.00).
78 Current limit reached	TRUE if current motor current ≥ maximum current. Otherwise FALSE. <ul style="list-style-type: none"> • Display of the present motor current in 0x2D88 (P104.00). • Setting for the maximum current in 0x6073 (P324.00).
79 Torque limit reached (from version 02.00)	TRUE if torque limit has been reached or exceeded. Otherwise FALSE. <ul style="list-style-type: none"> • Setting "Actual positive torque limit" in 0x2949:003 (P337.03). • Setting Actual negative torque limit in 0x2949:004 (P337.04). ▶ Motor torque monitoring □ 231
81 Error of analog input 1 active	TRUE if the monitoring of the input signal at the analog input 1 has responded. Otherwise FALSE. <p>This trigger is set as a function of the following settings:</p> <ul style="list-style-type: none"> • Monitoring threshold 0x2636:008 (P430.08) • Monitoring condition 0x2636:009 (P430.09) <p>The setting of the Error response in 0x2636:010 (P430.10) has no effect on this trigger.</p> <p>▶ Analog input 1 □ 240</p>
82 Error of analog input 2 active	TRUE if the monitoring of the input signal at the analog input 2 has responded. Otherwise FALSE. <p>This trigger is set as a function of the following settings:</p> <ul style="list-style-type: none"> • Monitoring threshold 0x2637:008 (P431.08) • Monitoring condition 0x2637:009 (P431.09) <p>The setting of the Error response in 0x2637:010 (P431.10) has no effect on this trigger.</p> <p>▶ Analog input 2 □ 244</p>
83 Load loss detected	TRUE if actual motor current < threshold for load loss detection after delay time of the load loss detection has elapsed. Otherwise FALSE. <ul style="list-style-type: none"> • Display of the actual current in 0x6078 (P103.00). • Setting Threshold in 0x4006:001 (P710.01). • Setting Delay time in 0x4006:002 (P710.02). ▶ Load loss detection □ 206



Start, stop and rotating direction commands

Flexible I/O configuration of the start, stop and rotating direction commands
Trigger list

Selection		Information
84	Heavy load monitoring	TRUE if the actual apparent current of the motor exceeds the threshold for longer than the delay time. FALSE if the actual apparent current of the motor falls below the threshold value minus 5 % (hysteresis). ▶ Heavy load monitoring □ 235
102	Sequence suspended (from version 03.00)	Status signal of the "sequencer" function: TRUE if the sequence is currently suspended. ▶ Sequencer □ 87
103	Sequence done (from version 03.00)	Status signal of the "sequencer" function: TRUE if the sequence is completed (final segment has been passed through). ▶ Sequencer □ 87
104	Local control active	TRUE if local keypad control ("LOC") active. Otherwise FALSE.
105	Remote control active	TRUE if remote control ("REM") via terminals, network, etc. active. Otherwise FALSE.
106	Manual setpoint selection active	TRUE if manual setpoint selection ("MAN") via keypad active. Otherwise FALSE. • Selection of the trigger for the "Activate keypad setpoint" function in 0x2631:016 (P400.16) .
107	Automatic setpoint selection active	TRUE if automatic setpoint selection ("AUTO") via terminals, network, etc. active. Otherwise FALSE.
201	Internal value (from version 05.00)	Internal values of the manufacturer.
202	Internal value (from version 05.00)	
203	Internal value (from version 05.00)	
204	Internal value (from version 05.00)	
205	Internal value (from version 05.00)	
206	Internal value (from version 05.00)	

Start, stop and rotating direction commands

Flexible I/O configuration of the start, stop and rotating direction commands
 Example: Start/stop (1 signal) and reversal



6.2.2 Example: Start/stop (1 signal) and reversal

This example shows a simple control option via two switches which should be sufficient for many applications:

- The switch S1 starts the motor in forward rotating direction. The switch S1 in the initial position stops the motor again.
- The switch S2 switches the direction of rotation.

Connection plan	Function
	Potentiometer R1: Frequency setpoint selection
	Switch S1: Run
	Switch S2: Reverse rotational direction

The example uses the preset I/O configuration of the inverter:

Parameter	Designation	Setting for this example (corresponds to default setting)
0x2631:001 (P400.01)	Enable inverter	Constant TRUE [1]
0x2631:002 (P400.02)	Run	Digital input 1 [11]
0x2631:013 (P400.13)	Reverse rotational direction	Digital input 3 [13]

Input signals

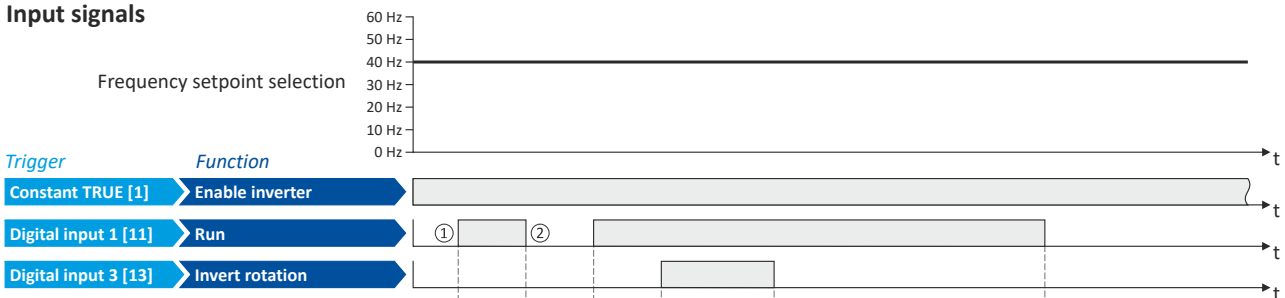

Output signals

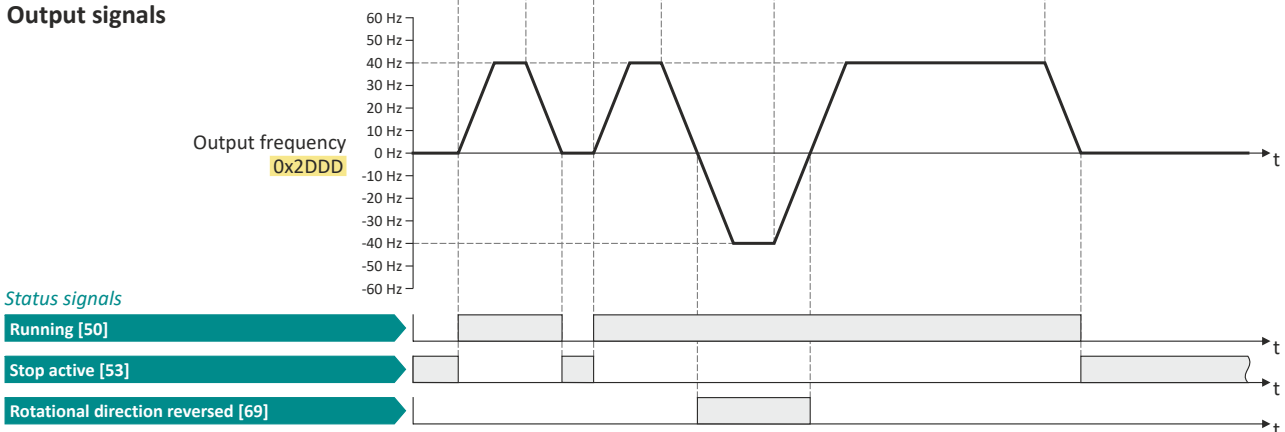

The status signals can be assigned to digital outputs. [▶ Configure digital outputs](#) 247

- ① If the inverter is enabled and no error is active, the motor can be started with the "Run" function in forward rotating direction.
- ② If "Run" is set to FALSE, the motor is stopped with the stop method set in 0x2838:003 (P203.03). In the example: Stop with standard ramp.



Start, stop and rotating direction commands

Flexible I/O configuration of the start, stop and rotating direction commands
 Example: Start forward/start reverse/stop (edge-controlled)

6.2.3 Example: Start forward/start reverse/stop (edge-controlled)



The "Run" function automatically becomes a "start enable" if the functions "Start forward (CW)" / "Start reverse (CCW)" are connected to triggers.

This example shows an edge-controlled start/stop via three buttons:

- In the non-operating state of button S1 (normally-closed contact), there is already a start enable.
- Button S2 starts the motor in forward rotating direction.
- Button S3 starts the motor in backward rotating direction.
- Button S1 (normally-closed contact) stops the motor by (short-time) cancellation of the start command. The inverter then waits for the next start command via button S2/S3.

Connection plan	Function	
	Potentiometer R1	Frequency setpoint selection
	Button S1	Stopping
	Button S2	Start forward (CW)
	Button S3	Start reverse (CCW)

Parameter	Name	Setting for this example
0x2631:001 (P400.01)	Enable inverter	Constant TRUE [1]
0x2631:002 (P400.02)	Run	Digital input 1 [11]
0x2631:004 (P400.04)	Reset fault	Not connected [0]
0x2631:006 (P400.06)	Start forward (CW)	Digital input 2 [12]
0x2631:007 (P400.07)	Start reverse (CCW)	Digital input 3 [13]
0x2631:013 (P400.13)	Reverse rotational direction	Not connected [0]

Start, stop and rotating direction commands

Flexible I/O configuration of the start, stop and rotating direction commands
 Example: Start forward/start reverse/stop (edge-controlled)

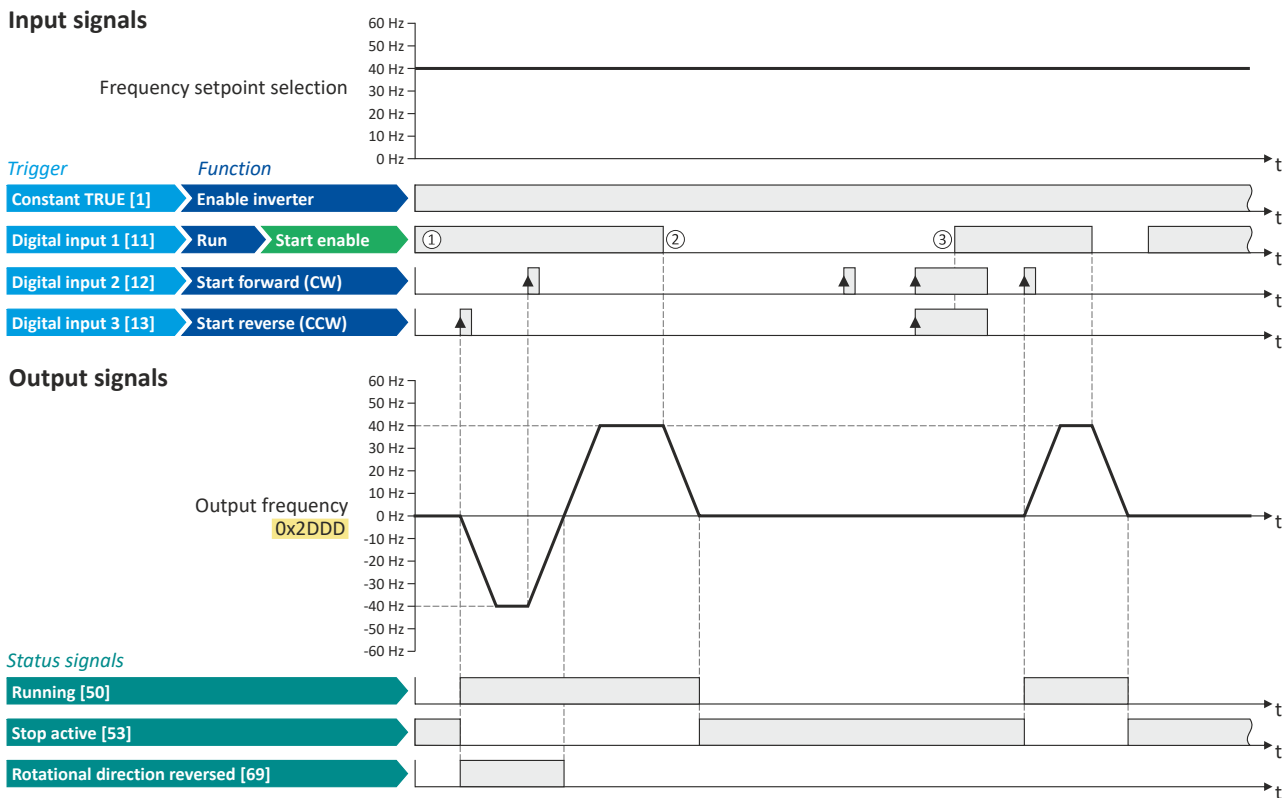

The status signals can be assigned to digital outputs. ▶ [Configure digital outputs](#) 247

- ① The "Run" function serves as start enable for the functions "Start forward (CW)" and "Start reverse (CCW)". Without start enable, the motor cannot be started.
- ② If the start command is cancelled, the motor is stopped with the stop method set in [0x2838:003 \(P203.03\)](#). In the example: Stop with standard ramp.
- ③ If, at start enable, "Start forward (CW)" and "Start reverse (CCW)" are already set to TRUE, the motor remains stopped and the inverter waits for the next valid start edge.



Start, stop and rotating direction commands

Flexible I/O configuration of the start, stop and rotating direction commands
 Example: Run forward/Run reverse/stop (status-controlled)

6.2.4 Example: Run forward/Run reverse/stop (status-controlled)



The "Run" function automatically becomes a "start enable" if the functions "Run forward (CW)"/"Run reverse (CCW)" are connected to triggers.

This example shows a status-controlled start/stop via three switches:

- Switch S1 enables the start. Without start enable, the motor cannot be started.
- Switch S2 starts the motor in forward direction of rotation.
- Switch S3 starts the motor in backward direction of rotation.
- The motor is stopped by cancelling the run commands (switches S2 and S3 open) or by cancelling the start enable (switch S1 open).

Connection plan	Function	
	Potentiometer R1	Frequency setpoint selection
	Switch S1	Start enable
	Switch S2	Run forward (CW)
	Switch S3	Run reverse (CCW)

Parameter	Designation	Setting for this example
0x2631:001 (P400.01)	Enable inverter	Constant TRUE [1]
0x2631:002 (P400.02)	Run	Digital input 1 [11]
0x2631:004 (P400.04)	Reset fault	Not connected [0]
0x2631:008 (P400.08)	Run forward (CW)	Digital input 2 [12]
0x2631:009 (P400.09)	Run reverse (CCW)	Digital input 3 [13]
0x2631:013 (P400.13)	Reverse rotational direction	Not connected [0]

Start, stop and rotating direction commands

Flexible I/O configuration of the start, stop and rotating direction commands
 Example: Run forward/Run reverse/stop (status-controlled)

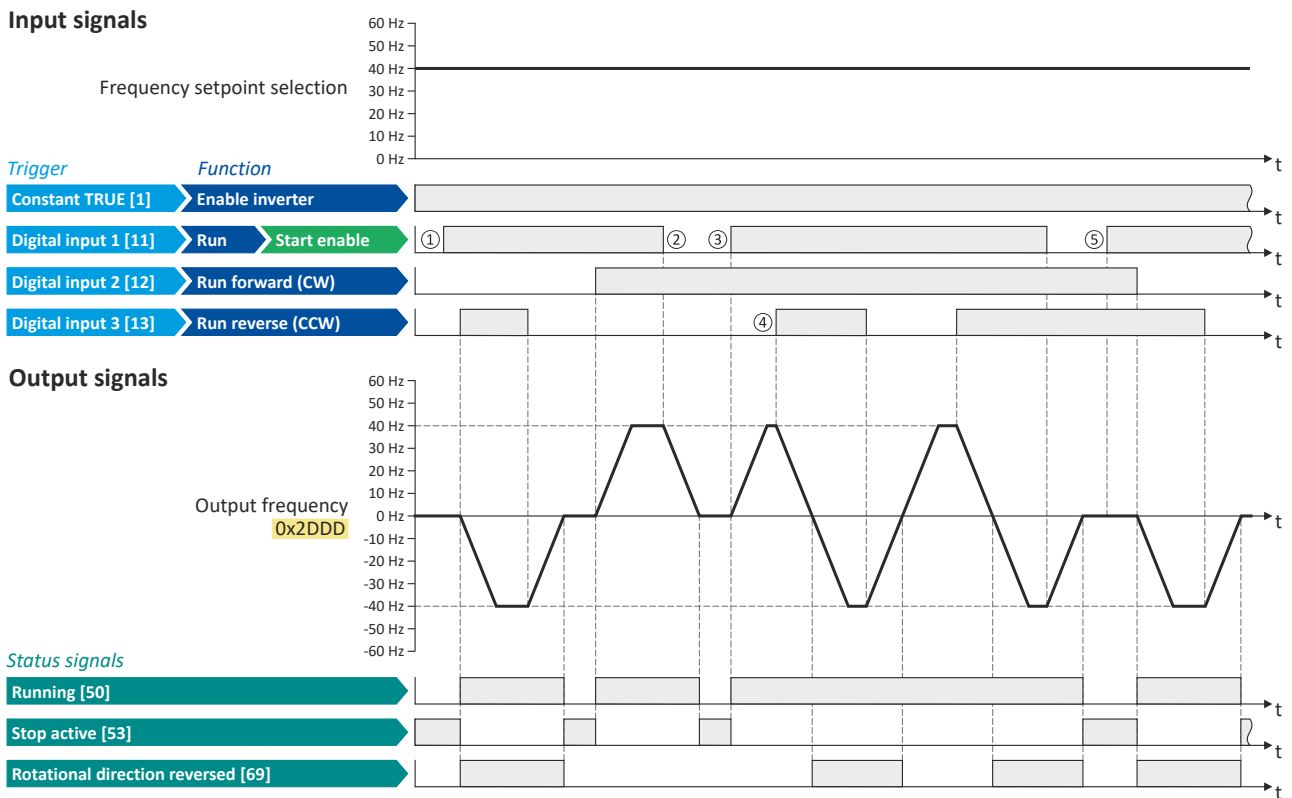

The status signals can be assigned to digital outputs. ▶ [Configure digital outputs](#) 247

- ① The "Run" function serves as start enable for the functions "Run forward (CW)" and "Run reverse (CCW)". Without start enable, the motor cannot be started.
- ② If the start command is cancelled, the motor is stopped with the stop method set in [0x2838:003 \(P203.03\)](#). In the example: Stop with standard ramp. After a renewed start enable, the inverter waits for the next run command.
- ③ If, at start enable, either "Run forward (CW)" or "Run reverse (CCW)" is set to TRUE, the motor starts in the triggered direction.
- ④ The inverter always responds to the run command detected last (if start enable is available). In the example, the "Run reverse (CCW)" command replaces the still active "Run forward (CW)" command.
- ⑤ If, at start enable, both run commands are set to TRUE, the motor remains stopped until only one valid run command is available.



Start, stop and rotating direction commands

Flexible I/O configuration of the start, stop and rotating direction commands
Example: Quick stop

6.2.5 Example: Quick stop

This example illustrates the "quick stop" function. If a quick stop is activated, the motor is brought to a standstill within the deceleration time set in [0x291C \(P225.00\)](#).

- The switch S1 starts the motor in forward rotating direction. The switch S1 in the initial position stops the motor again.
- The switch S2 activates the "quick stop" function.



Cancelling the quick stop causes a restart of the motor if the "Run" function is still active (switch S1 closed)!

Connection plan	Function	
	Potentiometer R1	Frequency setpoint selection
	Switch S1	Run
	Switch S2	Activate quick stop

Parameter	Name	Setting for this example
0x2631:001 (P400.01)	Enable inverter	Constant TRUE [1]
0x2631:002 (P400.02)	Run	Digital input 1 [11]
0x2631:003 (P400.03)	Activate quick stop	Digital input 2 [12]
0x2631:004 (P400.04)	Reset fault	Not connected [0]
0x2917 (P220.00)	Acceleration time 1	3.0 s
0x2918 (P221.00)	Deceleration time 1	3.0 s
0x291C (P225.00)	Quick stop deceleration time	1.0 s

Input signals

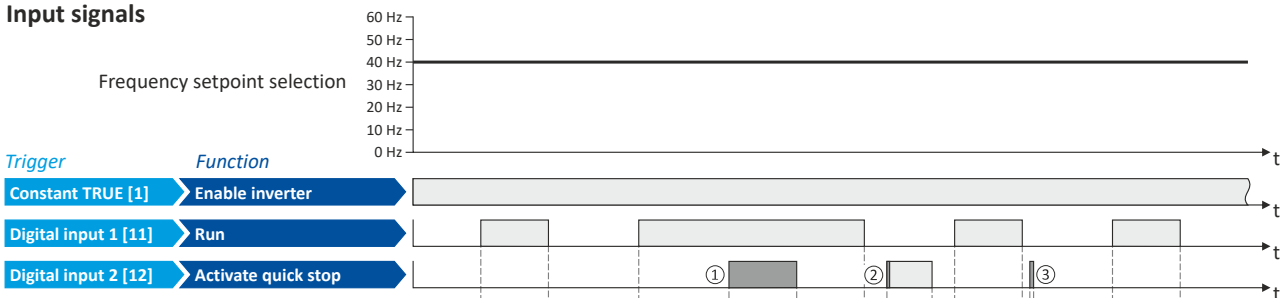

Output signals

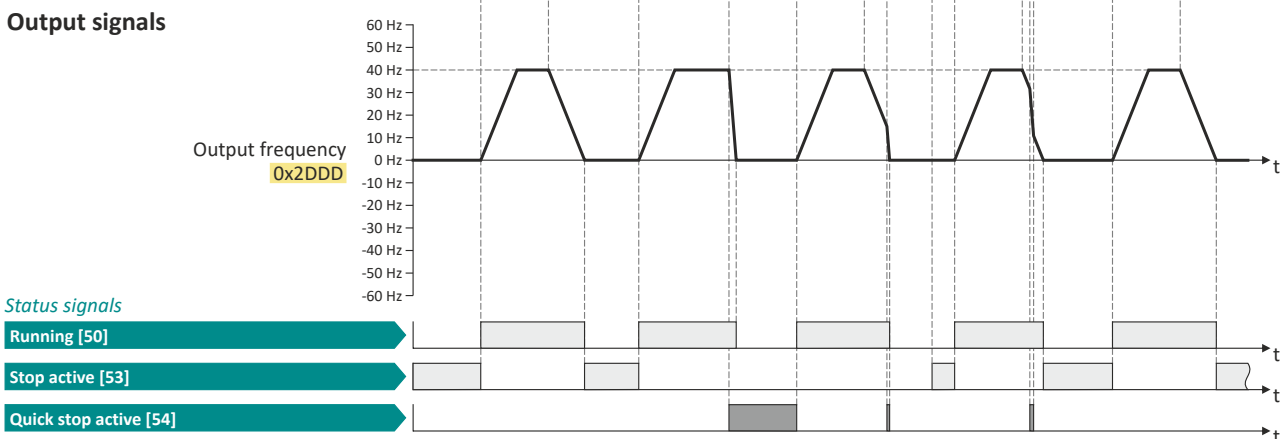

The status signals can be assigned to digital outputs. [▶ Configure digital outputs 247](#)

- ① If a quick stop is activated, the motor is decelerated to the frequency setpoint 0 Hz within a short period of time. The "Quick stop active [54]" status is set as long as quick stop is activated. The "Stop active [53]" status is not set.
- ② An active stop command is interrupted by a quick stop.
- ③ If quick stop is cancelled again before standstill is reached, stopping is continued with the stop method set in [0x2838:003 \(P203.03\)](#). In the example: Stop with standard ramp.

Start, stop and rotating direction commands

Flexible I/O configuration of the start, stop and rotating direction commands
 Example: Enable inverter



6.2.6 Example: Enable inverter

This example shows how to use the "Inverter enable" function for a separate enable input.

- In sleep mode of switch S1 (normally-closed contact), "Inverter enable" is already available.
- Switch S2 starts the motor in forward rotating direction (if switch S1 is closed). Switch S2 in initial position stops the motor again.
- Switch S1 disables the inverter. The motor becomes torqueless (coasts).

Connection plan	Function
	Potentiometer R1: Frequency setpoint selection
	Switch S1: Disable inverter
	Switch S2: Run

Parameter	Name	Setting for this example
0x2631:001 (P400.01)	Enable inverter	Digital input 1 [11]
0x2631:002 (P400.02)	Run	Digital input 2 [12]
0x2631:004 (P400.04)	Reset fault	Not connected [0]

Input signals

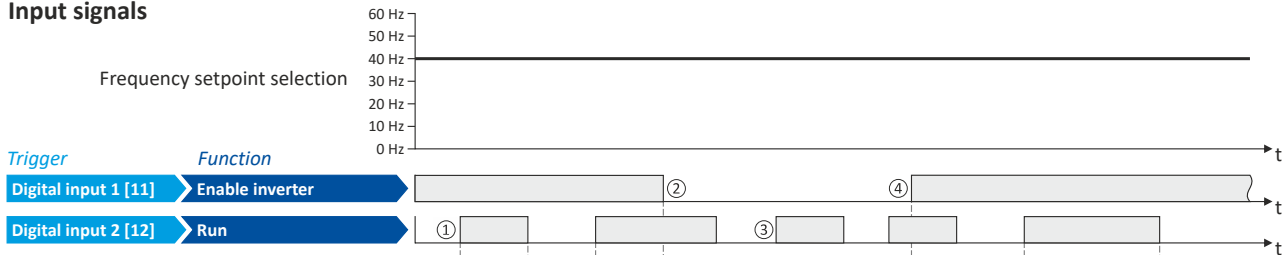

Output signals

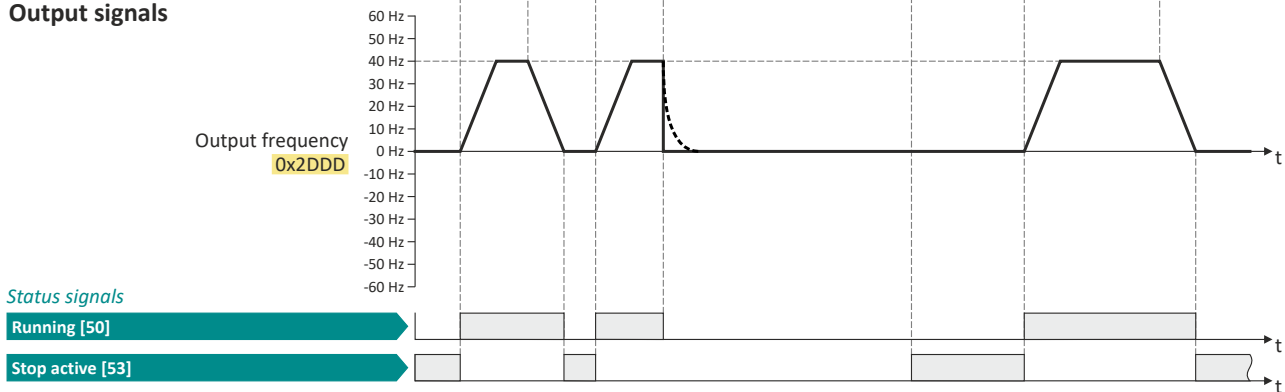

The status signals can be assigned to digital outputs. [▶ Configure digital outputs](#) 247

- ① If the inverter is enabled and no error is active, the motor can be started with the "Run" function in forward rotating direction.
- ② If "Inverter enable" is set to FALSE, the inverter is disabled. The motor becomes torqueless and coasts to standstill as a function of the mass inertia of the machine.
- ③ Without "Inverter enable", the motor cannot be started.
- ④ In the default setting, the motor does not start if the "Run" function is set to TRUE during "Inverter enable". "Start" has to be triggered again after "Inverter enable" to start the motor.
[▶ Start behavior](#) 39



Start, stop and rotating direction commands

Flexible I/O configuration of the start, stop and rotating direction commands
Example: Jog forward/Jog reverse

6.2.7 Example: Jog forward/Jog reverse

This example shows the functions "Jog forward (CW)" and "Jog reverse (CCW)" for Jog operation.

- The switch S1 starts the motor in forward rotating direction. The switch S1 in the initial position stops the motor again.
- The button S2 starts the motor in the forward direction of rotation with frequency preset 5.
- The button S3 starts the motor in the backward direction of rotation with frequency preset 6.
- The motor rotates in jog operation as long as the respective button is pressed. If both buttons are pressed at the same time, the motor is stopped.

CAUTION!

The jog operation has a higher priority than the "Run" function, all other start commands and the keypad key .

If jog operation is active, the motor cannot be stopped with the previously mentioned functions!

- ▶ The jog operation is stopped by cancelling the functions "Jog forward (CW)"/"Jog reverse (CCW)".
- ▶ The jog operation can be interrupted with the "Activate quick stop" [0x2631:003 \(P400.03\)](#) function.

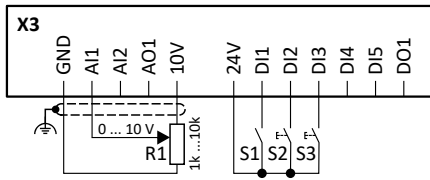
Connection plan	Function	
	Potentiometer R1	Frequency setpoint selection
	Switch S1	Run
	Button S2	Jog forward (CW)
	Button S3	Jog reverse (CCW)

Parameter	Name	Setting for this example
0x2631:001 (P400.01)	Enable inverter	Constant TRUE [1]
0x2631:002 (P400.02)	Run	Digital input 1 [11]
0x2631:004 (P400.04)	Reset fault	Not connected [0]
0x2631:010 (P400.10)	Jog forward (CW)	Digital input 2 [12]
0x2631:011 (P400.11)	Jog reverse (CCW)	Digital input 3 [13]
0x2631:013 (P400.13)	Reverse rotational direction	Not connected [0]
0x2911:005 (P450.05)	Frequency setpoint presets: Preset 5	15 Hz (is used for jog forward)
0x2911:006 (P450.06)	Frequency setpoint presets: Preset 6	10 Hz (is used for jog reverse)

Start, stop and rotating direction commands

Flexible I/O configuration of the start, stop and rotating direction commands
 Example: Jog forward/Jog reverse



Input signals

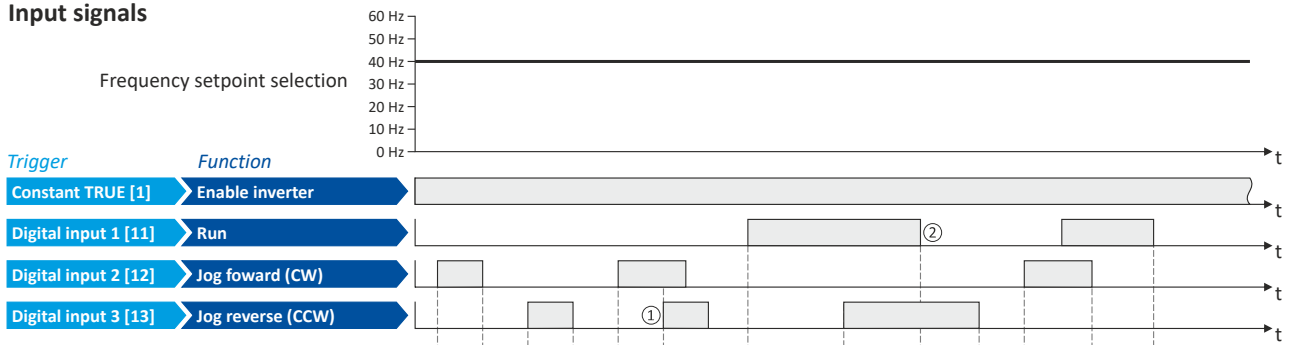

Output signals

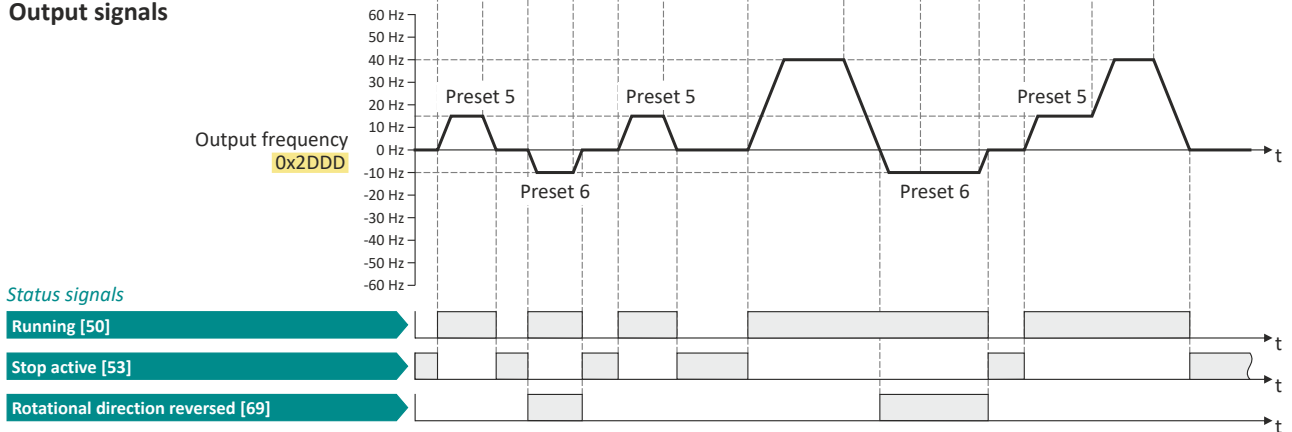

The status signals can be assigned to digital outputs. ▶ [Configure digital outputs](#) 247

- ① If "Jog forward (CW)" and "Jog reverse (CCW)" are activated at the same time, the motor is stopped with the stop method set in `0x2838:003` (`P203.03`) and the jog operation must be triggered again.
- ② The jog operation cannot be terminated with the "Run" function but only by cancelling the jog command.



Start, stop and rotating direction commands

Control/restrict direction of rotation of the motor

6.3 Control/restrict direction of rotation of the motor

In the default setting, both directions of motor rotation are enabled. Optionally, the direction of rotation can be restricted so that only a clockwise rotation (CW) of the motor is possible.

Preconditions

Wiring of the motor phases must be carried out correctly with regard to the direction of motor rotation.

In the documentation and the parameter selection texts, the following terms are used for the direction of rotation:

- Forward = clockwise direction of rotation (CW)
- Reverse = counter-clockwise direction of rotation (CCW)

Details

The direction of rotation of the motor can be controlled in various ways:

- Via the function "Reverse rotational direction". Possible triggers for the function "Reverse rotational direction" are available for selection in [0x2631:013 \(P400.13\)](#), e.g. the digital inputs and internal status signals of the inverter.
- Via the network. The definition of the direction of rotation is possible via the mappable NetWordIN1 data word or one of the predefined process data words.
- By specifying a bipolar setpoint value via an analog input. Either via a bipolar input range (-10 ... +10 V) or the configuration of a bipolar setting range.

If a reversal of rotation is not required, the direction of rotation can be restricted in [0x283A \(P304.00\)](#) to "Only clockwise (CW) [0]".

Parameter

Address	Name / setting range / [default setting]	Information
0x283A (P304.00)	Limitation of rotation (Limit. rotation)	Optional restriction of the rotating direction.
	0 Only clockwise (CW)	The motor can only be rotated clockwise (CW). The transfer of negative frequency and PID setpoints to the motor control is prevented. <ul style="list-style-type: none">• This function takes effect after the "Reverse rotational direction" function (0x2631:013 (P400.13)).• Since this function only prevents negative setpoints, counter-clockwise rotation (CCW) is possible if the motor has been wired for this rotating direction.
	1 Both rotational directions	Both directions of motor rotation are enabled.

Related topics

- ▶ [Example: Start/stop \(1 signal\) and reversal](#) 62

Start, stop and rotating direction commands

Changing the control source during operation



6.4 Changing the control source during operation

The term "control sources" in this connection refers to the digital signal sources from which the inverter receives its start, stop, and reversal commands.

Possible control sources:

- Digital inputs
- Keypad
- Network

Details

First, select in [0x2824 \(P200.00\)](#) whether the start of the motor is to be configured flexibly (default setting) or exclusively via the keypad. ▶ [Control selection](#) [49](#)

If "Flexible I/O configuration" is set, a change-over from one control source to another can be effected during operation via the functions listed in the following table. The inverter not only supports such a change-over via its digital inputs, but also as a function of internal inverter states.

Activate keypad control 0x2631:012 (P400.12)	Activate network control 0x2631:037 (P400.37)	Active control source
FALSE / Not connected	FALSE / Not connected	Flexible I/O configuration (default setting) <ul style="list-style-type: none"> • The motor is controlled via the digital inputs. • For preconfigured assignment of the digital inputs, see chapter "Function assignment of the inputs and outputs (default setting)". 44 • For description of the basic functions for controlling the motor, see chapter "Flexible I/O configuration of the start, stop and rotating direction commands". 54
FALSE / Not connected	TRUE	Network <ul style="list-style-type: none"> • Starting the motor is only possible via the network control word. • Exception: jog operation; see chapter "Flexible I/O configuration of the start, stop and rotating direction commands". 54 ▶ Example: Change-over from terminal control to network control 77
TRUE	Any	Keypad <ul style="list-style-type: none"> • Starting the motor is only possible via the  keypad key. • Exception: jog operation; see chapter "Flexible I/O configuration of the start, stop and rotating direction commands". 54 ▶ Example: Change-over from terminal control to keypad control 75

Parameter

Address	Name / setting range / [default setting]	Information
0x2631:012 (P400.12)	Function list: Activate keypad control (Function list: Keypad control) • Further possible settings: ▶ Trigger list 59	Assignment of a trigger for the "Activate keypad control" function. Trigger = TRUE: activate keypad as control source. Trigger = FALSE: no action / deactivate keypad as control source again.
	0 Not connected	No trigger assigned (trigger is constantly FALSE).
0x2631:037 (P400.37)	Function list: Activate network control (Function list: Network control) • Further possible settings: ▶ Trigger list 59	Assignment of a trigger for the "Activate network control" function. Trigger = TRUE: Activate network control. Trigger = FALSE: no action / deactivate network control again.
	0 Not connected	No trigger assigned (trigger is constantly FALSE).
	114 Network control active (from version 02.00)	TRUE if the network control is requested via bit 5 of the AC drive control word 0x400B:001 (P592.01) . Otherwise FALSE. Notes: • Set this selection if the network control is to be activated via bit 5 of the AC drive control word. • The AC drive control word can be used with any communication protocol. ▶ AC drive control word 305



Start, stop and rotating direction commands

Changing the control source during operation

Internal control logic

The following signal flow shows the internal control logic:

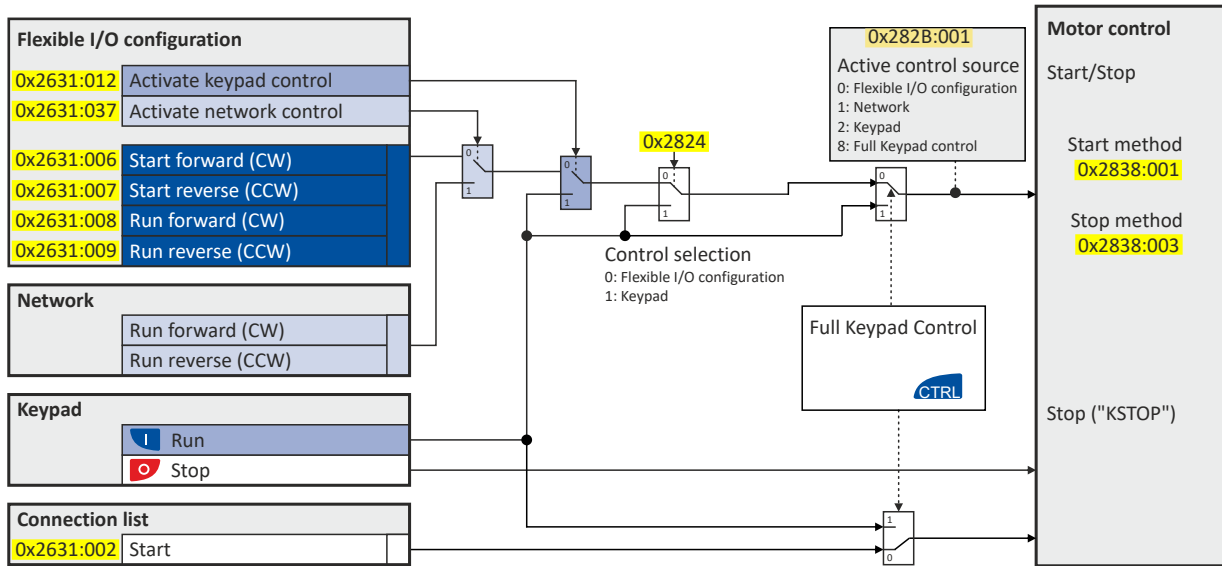

Notes:

In case of an activated **keypad or network control**, the "Run" 0x2631:002 (P400.02) function must be set to TRUE to start the motor in addition to the inverter enable, either via digital input or by the "Constant TRUE [1]" setting.

In case of an activated **network control**, the following functions are still active:

- 0x2631:001 (P400.01): Enable inverter
- 0x2631:002 (P400.02): Run
- 0x2631:003 (P400.03): Activate quick stop
- 0x2631:004 (P400.04): Reset error
- 0x2631:005 (P400.05): DC braking
- 0x2631:010 (P400.10): Jog forward (CW)
- 0x2631:011 (P400.11): Jog reverse (CCW)*
- 0x2631:012 (P400.12): Activate keypad control*
- 0x2631:037 (P400.37): Activate network control*
- 0x2631:043 (P400.43): Activate fault 1
- 0x2631:044 (P400.44): Activate fault 2
- 0x2631:054 (P400.54): Reset position counter

(*Not active in case of network operation in CiA402 mode 0x6060=2).

In case of an activated **network control**, the following functions are also still active if they are not configured in the NetWordIN1 bit functionality:

- 0x2631:048 (P400.48): Activate PID influence ramp
- 0x2631:041 (P400.41): Select parameter set (bit 0)
- 0x2631:042 (P400.42): Select parameter set (bit 1)

All other functions configurable via 0x2631:xx (P400.xx) are deactivated in case of network control.

In case of **keypad control**, the following functions continue to be active:

- 0x2631:001 (P400.01): Enable inverter
- 0x2631:002 (P400.02): Run
- 0x2631:003 (P400.03): Activate quick stop
- 0x2631:004 (P400.04): Reset error
- 0x2631:005 (P400.05): DC braking
- 0x2631:010 (P400.10): Jog forward (CW)
- 0x2631:011 (P400.11): Jog reverse (CCW)*
- All other functions of 0x2631:012 (P400.12) - 0x2631:055 (P400.55)

Start, stop and rotating direction commands

Changing the control source during operation



The functions for setpoint changeover. ▶ [Changing the setpoint source during operation](#)  125

Diagnostic parameters:

- [0x282A:001 \(P126.01\)](#): Cause of disable
- [0x282A:002 \(P126.02\)](#): Cause of quick stop
- [0x282A:003 \(P126.03\)](#): Cause of stop
- [0x282B:001 \(P125.01\)](#): Active control source





Start, stop and rotating direction commands

Changing the control source during operation

Example: Change-over from terminal control to keypad control

6.4.1 Example: Change-over from terminal control to keypad control

- The control is executed primarily via the I/O terminals: Switch S1 serves to start and stop the motor.
- Switch S2 serves to optionally change over to local keypad control. In case of activated keypad control, the motor can only be started via the  keypad key. However, the condition is that switch S1 is closed.
- If switch S1 is opened again or the  keypad key is pressed, the motor is stopped (irrespective of the active control source).
- For details of the keypad control of the inverter, see the chapter "[Keypad operating mode](#)".

 400

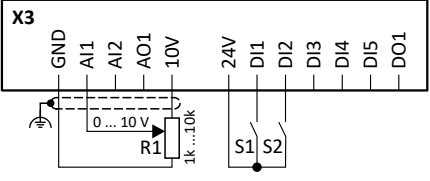
Connection plan	Function	
	Potentiometer R1	Frequency setpoint selection
	Switch S1	Run
	Switch S2	Activate keypad control

Parameter	Designation	Setting for this example
0x2631:001 (P400.01)	Enable inverter	Constant TRUE [1]
0x2631:002 (P400.02)	Run	Digital input 1 [11]
0x2631:004 (P400.04)	Reset fault	Not connected [0]
0x2631:012 (P400.12)	Activate keypad control	Digital input 2 [12]
0x2824 (P200.00)	Control selection	Flexible I/O configuration [0]

Start, stop and rotating direction commands

Changing the control source during operation

Example: Change-over from terminal control to keypad control



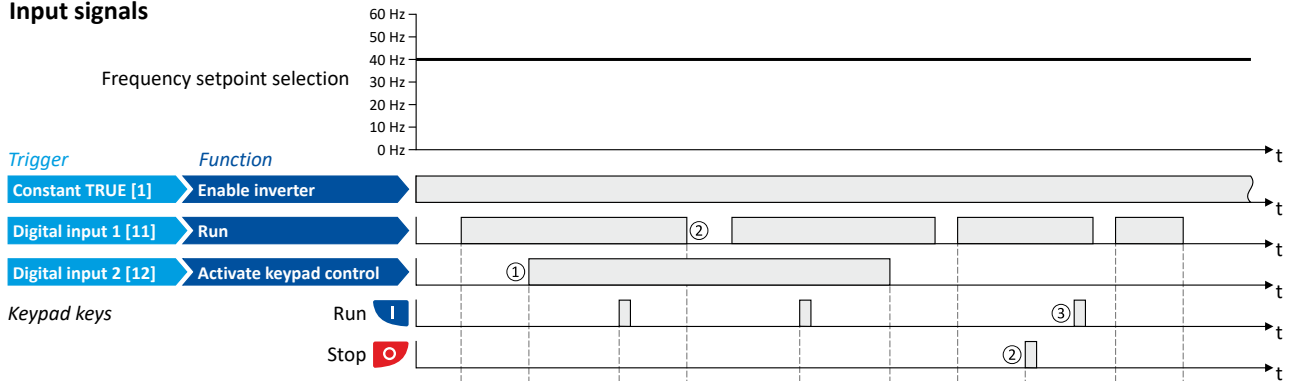

Input signals

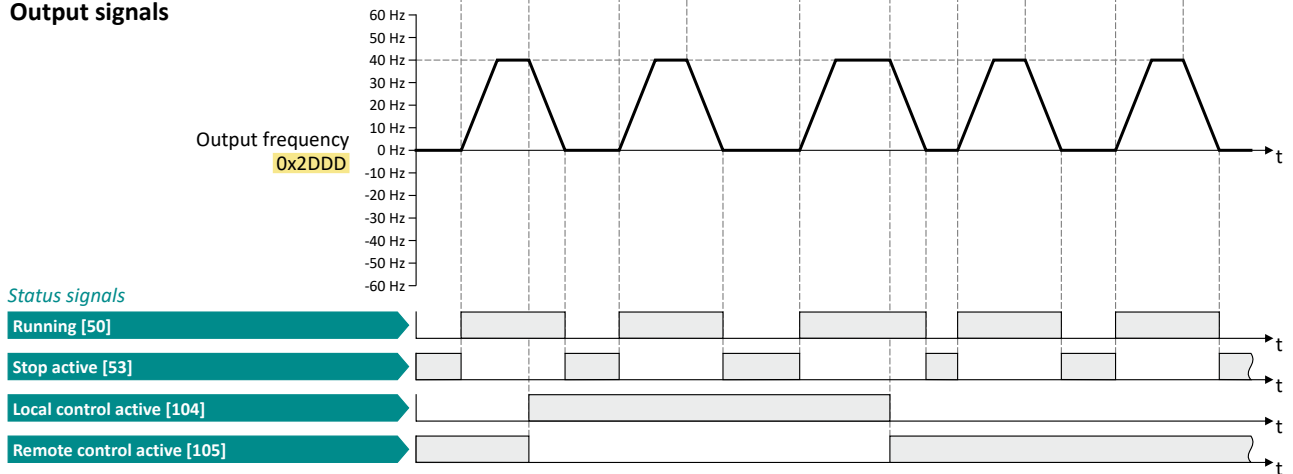

Output signals



The status signals can be assigned to digital outputs. [▶ Configure digital outputs](#) 247

- ① When changing over to another control source, the motor is first stopped with the stop method set in `0x2838:003 (P203.03)`.
- ② The motor will also be stopped if the "Run" function is deactivated or the  keypad key is pressed (irrespective of the active control source).
- ③ After stopping with the  keypad key and before a renewed start command from another control source, the  key on the keypad must be pressed to cancel the keypad stop again ("KSTOP").



Start, stop and rotating direction commands

Changing the control source during operation
 Example: Change-over from terminal control to network control

6.4.2 Example: Change-over from terminal control to network control

- The control is executed primarily via the I/O terminals. The switch S1 serves to start and stop the motor.
- Switch S2 serves to activate the network control. In case of activated keypad control, the motor can only be started via the network control word. However, the condition is that switch S1 is closed.
- If the switch S1 is opened again, the motor is stopped (irrespective of the active control source).

Connection plan	Function
	Potentiometer R1: Frequency setpoint selection
	Switch S1: Run
	Switch S2: Activate network control

Parameter	Name	Setting for this example
0x2631:001 (P400.01)	Enable inverter	Constant TRUE [1]
0x2631:002 (P400.02)	Run	Digital input 1 [11]
0x2631:004 (P400.04)	Reset fault	Not connected [0]
0x2631:037 (P400.37)	Activate network control	Digital input 2 [12]
0x2824 (P200.00)	Control selection	Flexible I/O configuration [0]

Input signals

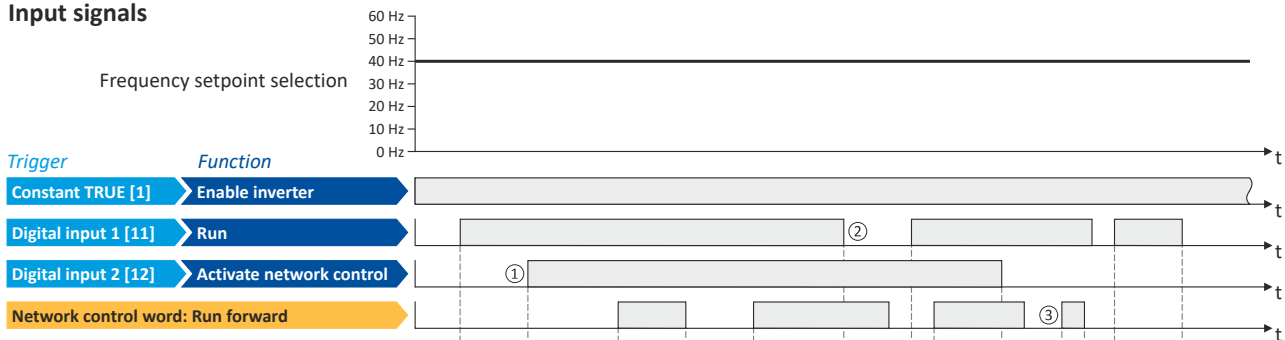

Output signals

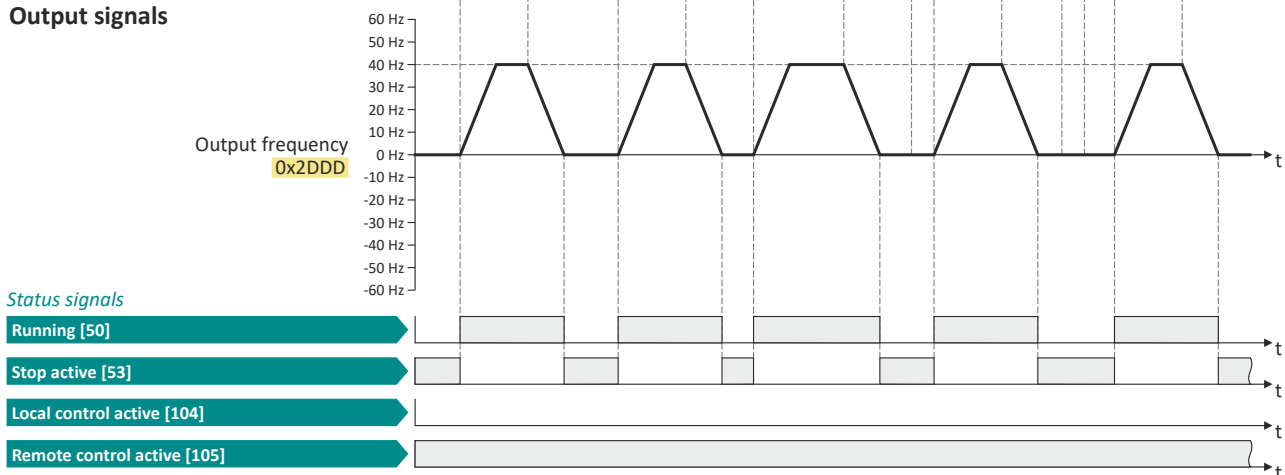

The status signals can be assigned to digital outputs. [▶ Configure digital outputs](#) 247

- ① When changing over to another control source, the motor is first stopped with the stop method set in [0x2838:003 \(P203.03\)](#).
- ② The motor will also be stopped if the "Run" function is deactivated (irrespective of the active control source).
- ③ Commands via the network are ignored if the network control is not active.

Configuring the frequency control

Basic setting
Standard setpoint source



7 Configuring the frequency control

7.1 Basic setting

In the following, the steps required for configuring the frequency control are described.

1. Set **0x6060 (P301.00)** to "MS: Velocity mode [-2]" operating mode (default setting).
2. Select the standard setpoint source for the frequency control in **0x2860:001 (P201.01)**.
3. Configure the selected standard setpoint source. ▶ [Configure setpoint sources](#) 82
4. Adjust the ramp times to the application. ▶ [Ramp times](#) 80
5. Optional: [Configuring the process controller](#) 112

The following signal flow shows the internal setpoint logics:

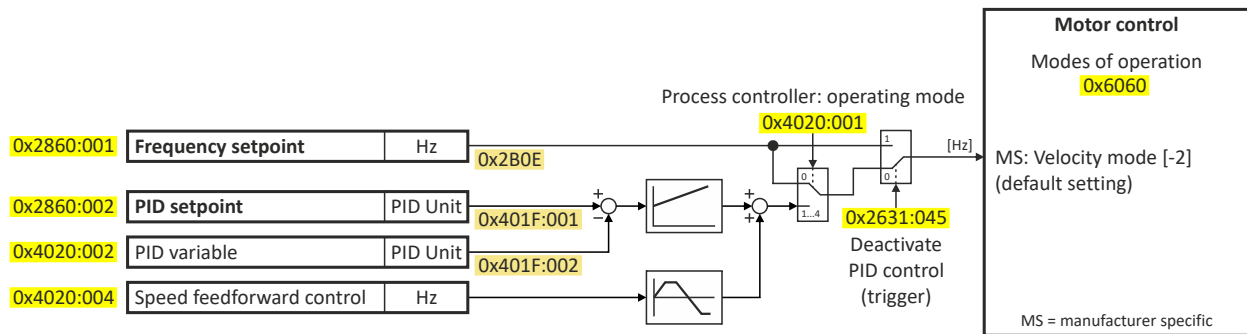

The frequency control is now active and the inverter responds to the frequency setpoint given by the selected setpoint source.

7.1.1 Standard setpoint source

The selected "setpoint source" serves to provide the inverter with its setpoint. The setpoint source can be selected individually for each operating mode.

Possible setpoint sources are:

- Analog inputs
- Keypad
- Network
- Parameterisable setpoints (presets)
- "Motor potentiometer" function
- "Sequencer" function

Details

- For applications only requiring one setpoint, it is sufficient to define the standard setpoint source in **0x2860:001 (P201.01)**.
- For applications requiring a change-over of the setpoint source during operation, the functions for setpoint change-over have to be configured accordingly. ▶ [Changing the setpoint source during operation](#) 125

Parameter

Address	Name / setting range / [default setting]	Information
0x2860:001 (P201.01)	Frequency control: Default setpoint source (Freq. setp. src.)	Selection of the standard setpoint source for operating mode "MS: Velocity mode". <ul style="list-style-type: none"> • The selected standard setpoint source is always active in the operating mode 0x6060 (P301.00) = "MS: Velocity mode [-2]" when no setpoint change-over to another setpoint source via corresponding triggers/functions is active. ▶ Changing the setpoint source during operation 125
	1 Keypad	The setpoint is specified locally by the keypad. <ul style="list-style-type: none"> • Default setting: 0x2601:001 (P202.01) • Use the ↑ and ↓ navigation keys to change the keypad setpoint (also during running operation).



Configuring the frequency control

Basic setting
Standard setpoint source

Address	Name / setting range / [default setting]	Information
2	Analog input 1	The setpoint is defined as analog signal via the analog input 1. ▶ Analog input 1 □ 240
3	Analog input 2	The setpoint is defined as analog signal via the analog input 2. ▶ Analog input 2 □ 244
4	HTL input (from version 04.00)	The digital inputs DI3 and DI4 can be configured as HTL input to use an HTL encoder as setpoint encoder or define the setpoint as a reference frequency ("pulse train").
5	Network	The setpoint is defined as process data object via the network. ▶ Define setpoint via network □ 273
11	Frequency preset 1	For the setpoint selection, preset values can be parameterised and selected. ▶ Setpoint presets □ 83
12	Frequency preset 2	
13	Frequency preset 3	
14	Frequency preset 4	
15	Frequency preset 5	
16	Frequency preset 6	
17	Frequency preset 7	
18	Frequency preset 8	
19	Frequency preset 9	
20	Frequency preset 10	
21	Frequency preset 11	
22	Frequency preset 12	
23	Frequency preset 13	
24	Frequency preset 14	
25	Frequency preset 15	
31	Segment preset 1 (from version 03.00)	For the setpoint selection, the segment presets parameterised for the "sequencer" function can be selected as well. ▶ Sequencer □ 87
32	Segment preset 2 (from version 03.00)	
33	Segment preset 3 (from version 03.00)	
34	Segment preset 4 (from version 03.00)	
35	Segment preset 5 (from version 03.00)	
36	Segment preset 6 (from version 03.00)	
37	Segment preset 7 (from version 03.00)	
38	Segment preset 8 (from version 03.00)	
50	Motor potentiometer	The setpoint is generated by the "motor potentiometer" function. This function can be used as an alternative setpoint control which is controlled via two signals: "MOP setpoint up" and "MOP setpoint down". ▶ Motor potentiometer (MOP) □ 85
201	Internal value (from version 05.00)	Internal values of the manufacturer.
202	Internal value (from version 05.00)	
203	Internal value (from version 05.00)	
204	Internal value (from version 05.00)	
205	Internal value (from version 05.00)	
206	Internal value (from version 05.00)	

Configuring the frequency control

Basic setting
Ramp times



7.1.2 Ramp times

The frequency setpoint is internally guided via a ramp generator. The acceleration time and the deceleration time are independently adjustable.

Details

- The acceleration time set in **0x2917 (P220.00)** refers to an acceleration from standstill to the maximum frequency set in **0x2916 (P211.00)**. At a low setpoint selection, the real acceleration time decreases accordingly.
- The deceleration time set in **0x2918 (P221.00)** refers to the deceleration of the set maximum frequency to standstill. In case of a lower actual frequency, the actual deceleration time is reduced accordingly.

Input signals

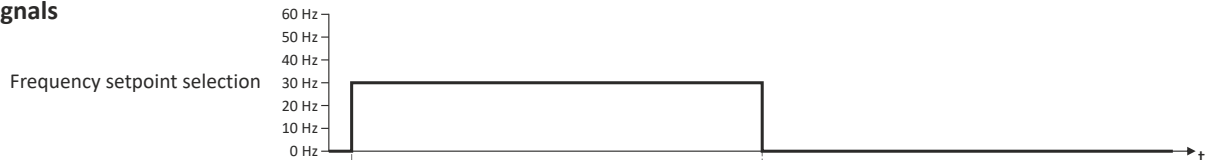

Output signals

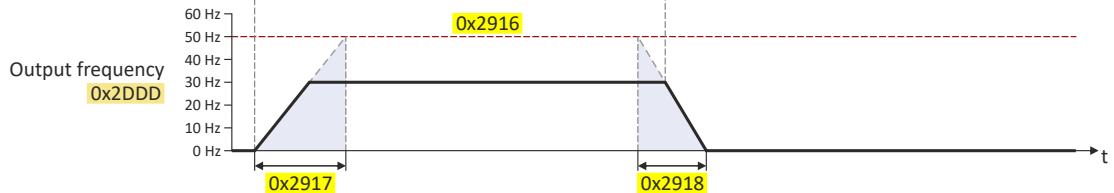

Parameter

Address	Name / setting range / [default setting]	Information
0x2917 (P220.00)	Acceleration time 1 (Accelerat.time 1) 0.0 ... [5.0] ... 3600.0 s	Acceleration time 1 for the operating mode "MS: Velocity mode". <ul style="list-style-type: none"> • The acceleration time set refers to the acceleration from standstill to the maximum frequency set. In the case of a lower setpoint selection, the actual acceleration time is reduced accordingly. • Setting is not effective in the operating mode 0x6060 (P301.00) = "CiA: Velocity mode [2]".
0x2918 (P221.00)	Deceleration time 1 (Decelerat.time 1) 0.0 ... [5.0] ... 3600.0 s	Deceleration time 1 for the operating mode "MS: Velocity mode". <ul style="list-style-type: none"> • The deceleration time set refers to the deceleration from the maximum frequency set to standstill. In the case of a lower actual frequency, the actual deceleration time is reduced accordingly. • Setting is not effective in the operating mode 0x6060 (P301.00) = "CiA: Velocity mode [2]".
0x291C (P225.00)	Quick stop deceleration time (QSP dec. time) 0.0 ... [1.0] ... 3600.0 s	Quick stop deceleration time for the operating mode "MS: Velocity mode". <ul style="list-style-type: none"> • If the "Quick stop" function is activated, the motor is brought to a standstill within the deceleration time set here. • The deceleration time set refers to the deceleration from the maximum frequency set to standstill. In the case of a lower actual frequency, the actual deceleration time is reduced accordingly. • Setting is not effective in the operating mode 0x6060 (P301.00) = "CiA: Velocity mode [2]". ▶ Example: Quick stop □ 67
0x291E:001 (P226.01)	S-Ramp characteristic: Smoothing factor (S-ramp char.: Smoothing factor) 0.0 ... [0.0] ... 100.0 %	Factor for S-rounding of the acceleration/deceleration ramps. <ul style="list-style-type: none"> • With the setting "0.0", the S-rounding is deactivated and acceleration/ deceleration with linear ramps is carried out. • The smoothing factor increases the ramp time as follows: 50 % --> 1.5 x configured ramp time 100 % --> 2 x configured ramp time



Configuring the frequency control

Basic setting
Ramp times

Example for operating mode

Parameter	Name	Setting for this example
0x2631:001 (P400.01)	Enable inverter	Constant TRUE [1]
0x2631:002 (P400.02)	Run	Digital input 1 [11]
0x2915 (P210.00)	Minimum frequency	15 Hz
0x2916 (P211.00)	Maximum frequency	40 Hz
0x2917 (P220.00)	Acceleration time 1	4 s
0x2918 (P221.00)	Deceleration time 1	3 s

Input signals

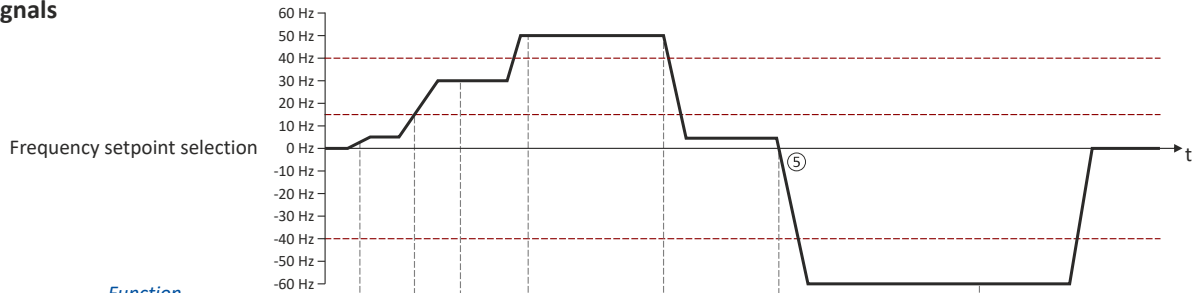

Trigger

Function

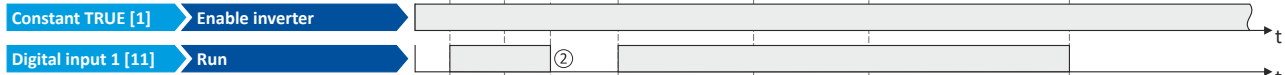

Output signals

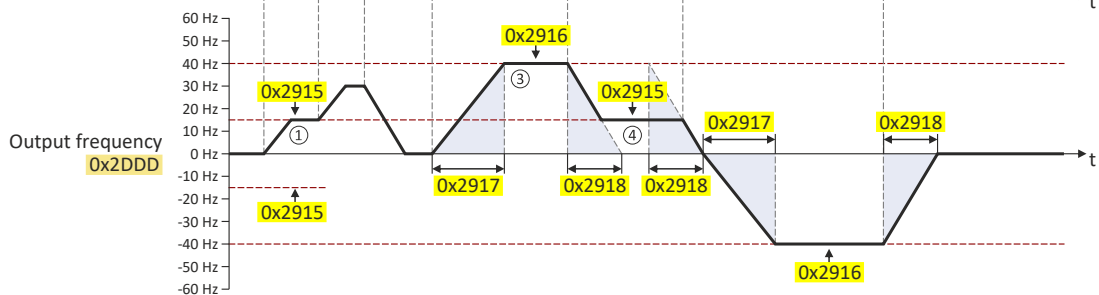

- ① After a start command, the motor is accelerated to the minimum frequency. This is also the case if the setpoint selection is = 0 Hz. If the setpoint exceeds the minimum frequency, the ramp generator follows the setpoint.
- ② If the start command is deactivated again, the motor is stopped with the stop method set in 0x2838:003 (P203.03) (here: Standard ramp).
- ③ The motor is accelerated to the set maximum frequency.
- ④ If the setpoint falls below the minimum frequency, it is decelerated up to the minimum frequency.
- ⑤ In case of a sign reversal of the setpoint, a change of direction of rotation takes place, the minimum and maximum frequency, however, continue to apply.

Configuring the frequency control

Configure setpoint sources
Keypad



7.2 Configure setpoint sources

The following setpoint sources are described in this chapter:

- [Keypad](#) 82
- [Setpoint presets](#) 83
- [Motor potentiometer \(MOP\)](#) 85
- [Sequencer](#) 87

Setpoint sources described in other chapters:

- [Analog input 1](#) 240
- [Analog input 2](#) 244
- Network: [Define setpoint via network](#) 273

7.2.1 Keypad

For the manual setpoint selection via keypad, the following default settings are used:

Parameter

Address	Name / setting range / [default setting]	Information
0x2601:001 (P202.01)	Keypad setpoints: Frequency setpoint (Keypad setpoints: KP freq.setpoint) 0.0 ... [20.0] ... 599.0 Hz	Default setting of the keypad setpoint for the operating mode 0x6060 (P301.00) = "MS: Velocity mode [-2]".
0x2601:002 (P202.02)	Keypad setpoints: Process controller setpoint (Keypad setpoints: KP PID setpoint) -300.00 ... [0.00] ... 300.00 PID unit	Default setting of the keypad setpoint for the reference value of the PID control.

The increment for keypad setpoints can be adapted in [0x2862 \(P701.00\)](#) by pressing a keypad arrow key once.

A switch-over to the keypad during operation is also possible as an alternative to the standard setpoint source setting.

- ▶ [Example: Change-over from AI1 setpoint to keypad setpoint](#) 131

Related topics

- ▶ [Keypad](#) 399



Configuring the frequency control

Configure setpoint sources
Setpoint presets

7.2.2 Setpoint presets

15 different frequency setpoints (presets) can be parameterised for the frequency control. 8 process controller setpoints (presets) can also be parameterised for the optional PID control.

Parameter

Address	Name / setting range / [default setting]	Information
0x2911:001 (P450.01)	Frequency setpoint presets: Preset 1 (Freq. presets: Freq. preset 1) 0.0 ... [20.0] ... 599.0 Hz	Parameterisable frequency setpoints (presets) for operating mode "MS: Velocity mode".
0x2911:002 (P450.02)	Frequency setpoint presets: Preset 2 (Freq. presets: Freq. preset 2) 0.0 ... [40.0] ... 599.0 Hz	
0x2911:003 (P450.03)	Frequency setpoint presets: Preset 3 (Freq. presets: Freq. preset 3) Device for 50-Hz mains: 0.0 ... [50.0] ... 599.0 Hz Device for 60-Hz mains: 0.0 ... [60.0] ... 599.0 Hz	
0x2911:004 (P450.04)	Frequency setpoint presets: Preset 4 (Freq. presets: Freq. preset 4) 0.0 ... [0.0] ... 599.0 Hz	
0x2911:005 (P450.05)	Frequency setpoint presets: Preset 5 (Freq. presets: Freq. preset 5) 0.0 ... [0.0] ... 599.0 Hz	
0x2911:006 (P450.06)	Frequency setpoint presets: Preset 6 (Freq. presets: Freq. preset 6) 0.0 ... [0.0] ... 599.0 Hz	
0x2911:007 (P450.07)	Frequency setpoint presets: Preset 7 (Freq. presets: Freq. preset 7) 0.0 ... [0.0] ... 599.0 Hz	
0x2911:008 (P450.08)	Frequency setpoint presets: Preset 8 (Freq. presets: Freq. preset 8) 0.0 ... [0.0] ... 599.0 Hz	
0x2911:009 (P450.09)	Frequency setpoint presets: Preset 9 (Freq. presets: Freq. preset 9) 0.0 ... [0.0] ... 599.0 Hz	
0x2911:010 (P450.10)	Frequency setpoint presets: Preset 10 (Freq. presets: Freq. preset 10) 0.0 ... [0.0] ... 599.0 Hz	
0x2911:011 (P450.11)	Frequency setpoint presets: Preset 11 (Freq. presets: Freq. preset 11) 0.0 ... [0.0] ... 599.0 Hz	
0x2911:012 (P450.12)	Frequency setpoint presets: Preset 12 (Freq. presets: Freq. preset 12) 0.0 ... [0.0] ... 599.0 Hz	
0x2911:013 (P450.13)	Frequency setpoint presets: Preset 13 (Freq. presets: Freq. preset 13) 0.0 ... [0.0] ... 599.0 Hz	
0x2911:014 (P450.14)	Frequency setpoint presets: Preset 14 (Freq. presets: Freq. preset 14) 0.0 ... [0.0] ... 599.0 Hz	
0x2911:015 (P450.15)	Frequency setpoint presets: Preset 15 (Freq. presets: Freq. preset 15) 0.0 ... [0.0] ... 599.0 Hz	

Configuring the frequency control

Configure setpoint sources

Setpoint presets



Address	Name / setting range / [default setting]	Information
0x4022:001 (P451.01)	PID setpoint presets: Preset 1 (PID presets: PID preset 1) -300.00 ... [0.00] ... 300.00 PID unit	Parameterisable process controller setpoints (presets) for PID control.
0x4022:002 (P451.02)	PID setpoint presets: Preset 2 (PID presets: PID preset 2) -300.00 ... [0.00] ... 300.00 PID unit	
0x4022:003 (P451.03)	PID setpoint presets: Preset 3 (PID presets: PID preset 3) -300.00 ... [0.00] ... 300.00 PID unit	
0x4022:004 (P451.04)	PID setpoint presets: Preset 4 (PID presets: PID preset 4) -300.00 ... [0.00] ... 300.00 PID unit	
0x4022:005 (P451.05)	PID setpoint presets: Preset 5 (PID presets: PID preset 5) -300.00 ... [0.00] ... 300.00 PID unit	
0x4022:006 (P451.06)	PID setpoint presets: Preset 6 (PID presets: PID preset 6) -300.00 ... [0.00] ... 300.00 PID unit	
0x4022:007 (P451.07)	PID setpoint presets: Preset 7 (PID presets: PID preset 7) -300.00 ... [0.00] ... 300.00 PID unit	
0x4022:008 (P451.08)	PID setpoint presets: Preset 8 (PID presets: PID preset 8) -300.00 ... [0.00] ... 300.00 PID unit	

A switch-over to a preset during operation is also possible as an alternative to the standard setpoint source setting.

▶ [Example: Change-over from keypad setpoint to preset 1 ... 7](#)  133



Configuring the frequency control

Configure setpoint sources
Motor potentiometer (MOP)

7.2.3 Motor potentiometer (MOP)

The "Motor potentiometer" function can be used as an alternative setpoint control that is controlled via two functions: "MOP setpoint up" and "MOP setpoint down".

Details

If the motor potentiometer is active as the setpoint source, the setpoint generated by this function ("MOP value") can be changed according to following the truth table via the triggers assigned to the two functions "MOP setpoint up" and "MOP setpoint down":

MOP setpoint up 0x2631:023 (P400.23)	MOP setpoint down 0x2631:024 (P400.24)	Response of the function
FALSE	FALSE	The last MOP value is maintained.
TRUE	FALSE	The MOP value is increased to a maximum of the upper limit value for the respective operating mode with the acceleration time 2. (The motor follows the setpoint change with acceleration time 1.)
FALSE	TRUE	The MOP value is increased to a maximum of the lower limit value for the respective operating mode with the deceleration time 2. (The motor follows the setpoint change with deceleration time 1.)
TRUE	TRUE	The last MOP value is maintained.

The start behavior can be selected in [0x4003 \(P413.00\)](#). In the default setting, the last MOP value is used as the initial value. The last MOP value remains available after switching the mains voltage off and on again. As an alternative, an adjustable initial value or the minimum value can be used for starting.

Parameter

Address	Name / setting range / [default setting]	Information
0x2631:023 (P400.23)	Function list: MOP setpoint up (Function list: MOP up) • Further possible settings: ▶ Trigger list 59	Assignment of a trigger for the "MOP setpoint up" function. Trigger = TRUE: setpoint generated by the "Motor potentiometer" function ("MOP value") is maximally increased to the upper range limit with acceleration time 2. Trigger = FALSE: last MOP value is maintained. Notes: • If the "MOP setpoint up" and "MOP setpoint down" functions are active at the same time, the last MOP value is maintained. • Acceleration time 2 can be set in 0x2919 (P222.00) .
	0 Not connected	No trigger assigned (trigger is constantly FALSE).
0x2631:024 (P400.24)	Function list: MOP setpoint down (Function list: MOP down) • Further possible settings: ▶ Trigger list 59	Assignment of a trigger for the "MOP setpoint down" function. Trigger = TRUE: setpoint generated by the "Motor potentiometer" function ("MOP value") is maximally decreased to the lower range limit with deceleration time 2. Trigger = FALSE: last MOP value is maintained. Notes: • If the "MOP setpoint up" and "MOP setpoint down" functions are active at the same time, the last MOP value is maintained. • Deceleration time 2 can be set in 0x291A (P223.00) .
	0 Not connected	No trigger assigned (trigger is constantly FALSE).
0x4003 (P413.00)	MOP starting mode (MOP startmode)	Selection of the initial value which is used after activation of the function.
	0 Last value	The last MOP value is used as initial value. It is still provided after the mains voltage has been switched off and on again. Note: The last MOP value is saved in the internal EEPROM of the inverter. If the memory module is transferred to a compatible device, the last MOP value will therefore not be accepted.
	1 Starting value	The starting value of the corresponding operating mode is used as initial value: • 0x4004:001 (P414.01) for the operating mode "MS: Velocity mode" • 0x4004:002 (P414.02) for PID control • 0x4004:003 (P414.03) for the operating mode "MS: Torque mode"
	2 Minimum value	The minimum value of the corresponding operating mode is used as initial value: • 0x2915 (P210.00) for the operating mode "MS: Velocity mode" • 0x404E:001 (P605.01) for PID control

Configuring the frequency control

Configure setpoint sources
Motor potentiometer (MOP)



Address	Name / setting range / [default setting]	Information
0x4004:001 (P414.01)	MOP starting values: Frequency (MOP start value: Frequency) 0.0 ... [0.0] ... 599.0 Hz	Starting value for operating mode "MS: Velocity mode". • This value is used as initial value if "Starting value [1]" is set in 0x4003 (P413.00) .
0x4004:002 (P414.02)	MOP starting values: PID value (MOP start value: PID value) -300.00 ... [0.00] ... 300.00 PID unit	Starting value for reference value of the PID control. • This value is used as initial value if "Starting value [1]" is set in 0x4003 (P413.00) .
0x4004:003 (P414.03)	MOP starting values: Torque (MOP start value: Torque) 0.0 ... [0.0] ... 1000.0 %	Starting value for operating mode "MS: Torque mode". • This value is used as initial value if "Starting value [1]" is set in 0x4003 (P413.00) . • 100 % = motor rated torque (0x6076 (P325.00)).
0x4009:001	MOP values saved: Frequency • Read only: x.x Hz	Display of the last MOP value saved internally for the operating mode "MS: Velocity mode". • This value is used as initial value if "Last value [0]" is set in 0x4003 (P413.00) .
0x4009:002	MOP values saved: PID value • Read only: x.xx PID unit	Display of the last MOP value saved internally for the reference value of the PID control. • This value is used as initial value if "Last value [0]" is set in 0x4003 (P413.00) .
0x4009:003	MOP values saved: Torque • Read only: x.x %	Display of the last MOP value saved internally for the operating mode "MS: Torque mode". • This value is used as initial value if "Last value [0]" is set in 0x4003 (P413.00) . • 100 % = motor rated torque (0x6076 (P325.00)).

A switch-over to the motor potentiometer during operation is also possible as an alternative to the standard setpoint source setting.

► [Example: Change-over from AI1 setpoint to MOP setpoint](#) 136



7.2.4 Sequencer

The "sequencer" function serves to transfer a programmed sequence of setpoints to the motor control. The switch-over to the next setpoint can be made time-controlled or even-controlled. Optionally, the "sequencer" function can also trigger the digital and analog outputs.



The sequencer only generates setpoints. However, the sequencer does not control the motor operation (does not output any start and stop commands).

Basics: Sequences, steps and segments

- Overall, sequences with the numbers 1 to 8 can be configured.
- Each sequence consists of 16 configurable steps.
- Each step of a sequence can call a "segment".
 - A segment contains, among other things preset setpoints (speed setpoint, PID control value, torque setpoint), a combined acceleration/deceleration for the speed setpoint and optionally a configuration for the digital and analog outputs.
 - 8 different segments and one end segment can be configured.
- Alternatively to calling a single segment, a complete sequence (with a higher number) can also be called from one step. This serves to implement nested sequences or summarize several sequences to one sequence.

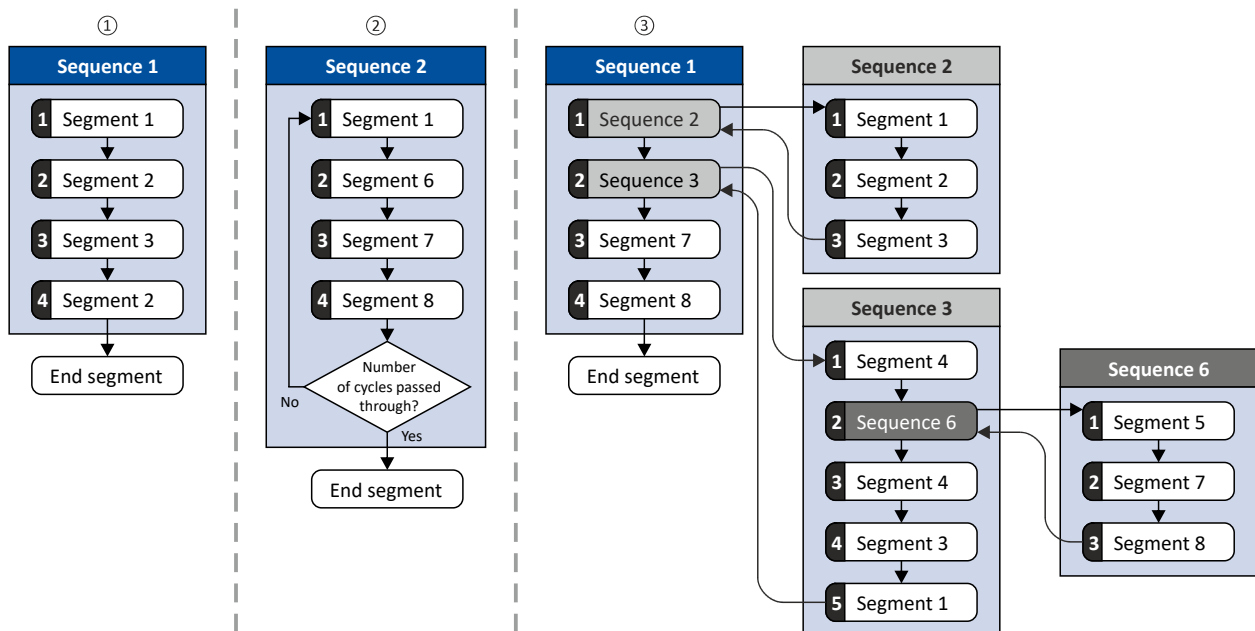

- Simple sequence with four steps.
- Simple sequence with four steps that are passed through several times (number of cycles > 1). For each sequence, the number of cycles can be set individually.
- Nested sequence, in which other (sub) sequences are called by one (main) sequence.

Configuring the frequency control

Configure setpoint sources
Sequencer



Commissioning

For commissioning the sequencer, we recommend the following proceeding:

1. Configure segments (including end segment).
Details: [▶ Segment configuration](#) 108
2. Configure sequences:
 - a) Assign the segments to the single steps of a sequence.
 - b) Set the number of cycles for the respective sequence.Details: [▶ Sequence configuration](#) 109
3. Make the basic setting of the sequencer:
 - a) Set the desired operating mode (time and/or step operation).
 - b) Optionally adjust the sequence end mode and the sequence start mode.Details: [▶ Sequencer basic settings](#) 103
4. Configure the control of the sequencer:
 - a) Assign the functions for selecting a sequence to suitable triggers (e. g. digital inputs).
 - b) Assign the functions for controlling the sequencer (start, stop, cancel, ...) to suitable triggers.Details: [▶ Sequencer control functions](#) 106

Control

The sequencer can be controlled with the following function. For details, see chapter "[Sequencer control functions](#)". 106

Function	Information
Select sequence (bit 0) ... Select sequence (bit 3)	Bit coded selection of the sequence to be started.
Start sequence	The selected sequence is started. The start can take place edge or status-controlled depending on the configuration.
Next sequence step	Immediate jump to the next step irrespective of the time set for the segment.
Pause sequence	The sequencer stops in the current step. The elapsing time set for the segment is stopped. The sequencer setpoint remains active.
Suspend sequence	There is a temporary return to the normal setpoint control. The sequence is then continued at the point where it was suspended.
Stop sequence	Direct jump to the end segment. The further execution depends on the selected end of sequence mode.
Abort sequence	Immediate return to the normal setpoint control. The end segment is not executed anymore.

Diagnostics

For diagnosing the sequencer, the diagnostic parameters listed in chapter "[Sequencer diagnostics](#)" are available. 110

Internal status signals

The sequencer provides different internal status signals (see the following table). These status signals can be assigned to the relay, the digital outputs or the status word NetWordOUT1.

[▶ Configure digital outputs](#) 247

Internal status signal	Information
"Sequencer controlled [100]"	The control is executed via the sequencer (according to the configuration of the digital outputs for the current segment).
"Sequence active [101]"	The sequence is running and is currently not suspended.
"Sequence suspended [102]"	The sequence is currently suspended.
"Sequence done [103]"	The sequence is completed (end segment was passed through).



Configuring the frequency control

Configure setpoint sources
Sequencer

7.2.4.1 Segment configuration

Each step of a sequence can call a "segment". A segment contains, among other things preset setpoints (speed setpoint, PID control value, torque setpoint), a combined acceleration/ deceleration for the speed setpoint and optionally a configuration for the digital and analog outputs.

Details

As a total, 8 segments and one end segment can be configured.

- The settings are only effective if a sequence is active and the respective segment is executed.
- Only those settings that are relevant for the corresponding operating mode must be made; i.e. if the PID control is not used, no PID setpoint has to be set for the segment.
- The following figure shows the segment settings relevant for the operating mode **0x6060 (P301.00) = "MS: Velocity mode [-2]"**.
- The table below provides a brief overview of the possible settings of the different segments.

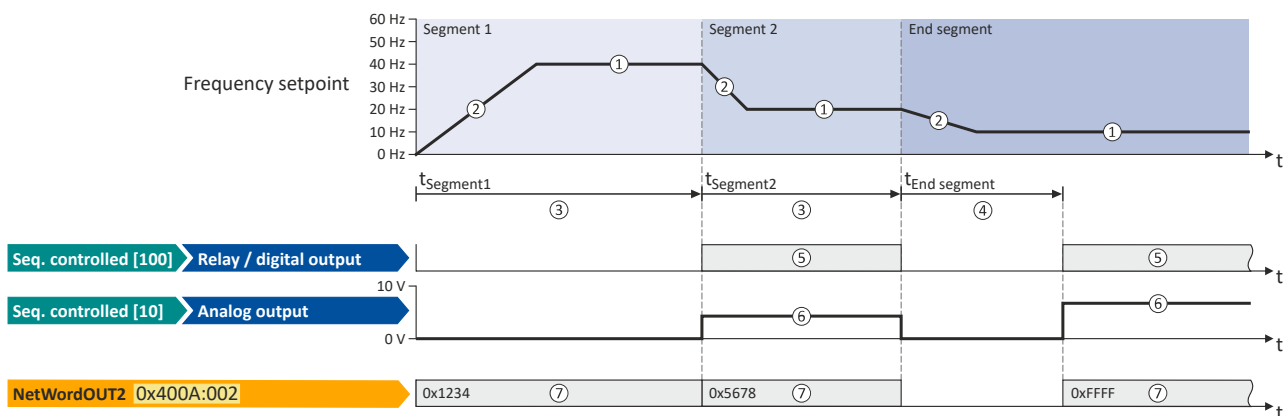

Setting		Info
Frequency setpoint	①	Only relevant for the operating mode 0x6060 (P301.00) = "MS: Velocity mode [-2]" . The direction of rotation is implemented according to the sign.
Acceleration/deceleration	②	Only relevant for the operating mode 0x6060 (P301.00) = "MS: Velocity mode [-2]" . The set time refers to the acceleration from standstill to the set maximum frequency. The deceleration is effected with the same ramp.
Time	③	Meaning for segment 1 ... 8: Runtime for the segment after the expiration of which it is switched over to the next step of the sequence. Only relevant for Sequencer mode 0x4025 (P800.00) = "Time operation [1]" or "Time & step operation [3]".
	④	Meaning for end segment: Delay time for activating the output states configured for the end segment.
Digital outputs	⑤	Optionally: Set digital outputs to a certain level for the execution time of the segment.
Analog outputs	⑥	Optionally: Set analog outputs to an adjustable voltage value for the execution time of the segment.
PID setpoint		Only relevant if the PID control in 0x4020:001 (P600.01) is activated. ▶ Configuring the process controller □ 112
Torque setpoint		Only relevant for the operating mode 0x6060 (P301.00) = "MS: Torque mode [-1]" . ▶ Configuring the torque control □ 146
NetWordOUT2	⑦	Optionally: Set the NetWordOUT2 data word to an adjustable value for the execution time of the segment. The NetWordOUT2 data word 0x400A:002 (P591.02) can be mapped to a network register to transfer the set value as process data. ▶ Output messages of the "sequencer" function via network □ 281

In the following, all parameters relevant for the segment configuration are given.



If the sequencer is active, write accesses to all parameters are blocked that concern the active segment configuration!

Configuring the frequency control

Configure setpoint sources
Sequencer



Parameter

Address	Name / setting range / [default setting]	Information
0x4026:001 (P801.01)	Sequencer segment 1: Frequency setpoint (Segment 1: Frequency setp.) -599.0 ... [0.0] ... 599.0 Hz • From version 03.00	Frequency setpoint for the segment. • Only relevant for operating mode 0x6060 (P301.00) = "MS: Velocity mode [-2]". • Direction of rotation according to sign.
0x4026:002 (P801.02)	Sequencer segment 1: Acceleration/deceleration (Segment 1: Accel./decel.) 0.0 ... [5.0] ... 3600.0 s • From version 03.00	Acceleration/deceleration for the segment. • Only relevant for operating mode 0x6060 (P301.00) = "MS: Velocity mode [-2]". • The set time refers to the acceleration from standstill to the set maximum frequency. The deceleration is effected with the same ramp.
0x4026:003 (P801.03)	Sequencer segment 1: Time (Segment 1: Time) 0.0 ... [0.0] ... 100000.0 s • From version 03.00	Runtime for the segment after the expiry of which it is switched over to the next step of the sequence. • Only relevant for Sequencer mode 0x4025 (P800.00) = "Time operation [1]" or "Time & step operation [3]". • With the setting "0.0", the segment will be skipped.
0x4026:004 (P801.04)	Sequencer segment 1: Digital outputs (Segment 1: Digital outp.) 0 ... [0] ... 255 • From version 03.00	Optionally: Set digital outputs to the level set here for the execution time of the segment. Note! In order that the control of a digital output is executed by the sequencer, the following assignment must be made for the respective digital output: • Relay: 0x2634:001 (P420.01) = "Sequencer controlled [100]" • Digital output 1: 0x2634:002 (P420.02) = "Sequencer controlled [100]"
	Bit 0 Relay	0 = X9/NO-COM open and NC-COM closed. 1 = X9/NO-COM closed and NC-COM open. An inversion set in 0x2635:001 (P421.01) is taken into consideration here.
	Bit 1 Digital output 1	0 = set digital output 1 to LOW level. 1 = set digital output 1 to HIGH level. An inversion set in 0x2635:002 (P421.02) is taken into consideration here.
	Bit 2 Digital output 2	Function is not supported in this device.
0x4026:005 (P801.05)	Sequencer segment 1: Analog outputs (Segment 1: Analog outp.) 0.00 ... [0.00] ... 10.00 VDC • From version 03.00	Optionally: Set analog output to the voltage value set here for the execution time of the segment. Note! In order that the control of the analog output is executed by the sequencer, the following assignment must be made for the analog output: • Analog output 1: 0x2639:002 (P440.02) = "Sequencer controlled [10]"
0x4026:006 (P801.06)	Sequencer segment 1: PID setpoint (Segment 1: PID setp.) -300.00 ... [0.00] ... 300.00 PID unit • From version 03.00	PID control value for the segment. • Only relevant if the PID control in 0x4020:001 (P600.01) is activated.
0x4026:007 (P801.07)	Sequencer segment 1: Torque setpoint (Segment 1: Torque setp.) -400.0 ... [100.0] ... 400.0 % • From version 03.00	Torque setpoint for the segment. • Only relevant for operating mode 0x6060 (P301.00) = "MS: Torque mode [-1]".
0x4026:008	Sequencer segment 1: NetWordOUT2 0 ... [0] ... 65535 • From version 03.00	Optionally: Set the NetWordOUT2 data word to the value set here for the execution time of the segment. • The NetWordOUT2 data word 0x400A:002 (P591.02) can be mapped to a network register to transfer the set value as process date.
0x4026:009	Sequencer segment 1: Reserved 0 ... [0] ... 4294967295.0 • From version 03.00	
0x4027:001 (P802.01)	Sequencer segment 2: Frequency setpoint (Segment 2: Frequency setp.) -599.0 ... [0.0] ... 599.0 Hz • From version 03.00	Frequency setpoint for the segment. • Only relevant for operating mode 0x6060 (P301.00) = "MS: Velocity mode [-2]". • Direction of rotation according to sign.
0x4027:002 (P802.02)	Sequencer segment 2: Acceleration/deceleration (Segment 2: Accel./decel.) 0.0 ... [5.0] ... 3600.0 s • From version 03.00	Acceleration/deceleration for the segment. • Only relevant for operating mode 0x6060 (P301.00) = "MS: Velocity mode [-2]". • The set time refers to the acceleration from standstill to the set maximum frequency. The deceleration is effected with the same ramp.



Configuring the frequency control

Configure setpoint sources
Sequencer

Address	Name / setting range / [default setting]	Information
0x4027:003 (P802.03)	Sequencer segment 2: Time (Segment 2: Time) 0.0 ... [0.0] ... 100000.0 s • From version 03.00	Runtime for the segment after the expiry of which it is switched over to the next step of the sequence. • Only relevant for Sequencer mode 0x4025 (P800.00) = "Time operation [1]" or "Time & step operation [3]". • With the setting "0.0", the segment will be skipped.
0x4027:004 (P802.04)	Sequencer segment 2: Digital outputs (Segment 2: Digital outp.) 0 ... [0] ... 255 • From version 03.00	Optionally: Set digital outputs to the level set here for the execution time of the segment. Note! In order that the control of a digital output is executed by the sequencer, the following assignment must be made for the respective digital output: • Relay: 0x2634:001 (P420.01) = "Sequencer controlled [100]" • Digital output 1: 0x2634:002 (P420.02) = "Sequencer controlled [100]"
	Bit 0 Relay	0 = X9/NO-COM open and NC-COM closed. 1 = X9/NO-COM closed and NC-COM open. An inversion set in 0x2635:001 (P421.01) is taken into consideration here.
	Bit 1 Digital output 1	0 = set digital output 1 to LOW level. 1 = set digital output 1 to HIGH level. An inversion set in 0x2635:002 (P421.02) is taken into consideration here.
	Bit 2 Digital output 2	Function is not supported in this device.
0x4027:005 (P802.05)	Sequencer segment 2: Analog outputs (Segment 2: Analog outp.) 0.00 ... [0.00] ... 10.00 VDC • From version 03.00	Optionally: Set analog output to the voltage value set here for the execution time of the segment. Note! In order that the control of the analog output is executed by the sequencer, the following assignment must be made for the analog output: • Analog output 1: 0x2639:002 (P440.02) = "Sequencer controlled [10]"
0x4027:006 (P802.06)	Sequencer segment 2: PID setpoint (Segment 2: PID setp.) -300.00 ... [0.00] ... 300.00 PID unit • From version 03.00	PID control value for the segment. • Only relevant if the PID control in 0x4020:001 (P600.01) is activated.
0x4027:007 (P802.07)	Sequencer segment 2: Torque setpoint (Segment 2: Torque setp.) -400.0 ... [100.0] ... 400.0 % • From version 03.00	Torque setpoint for the segment. • Only relevant for operating mode 0x6060 (P301.00) = "MS: Torque mode [-1]".
0x4027:008	Sequencer segment 2: NetWordOUT2 0 ... [0] ... 65535 • From version 03.00	Optionally: Set the NetWordOUT2 data word to the value set here for the execution time of the segment. • The NetWordOUT2 data word 0x400A:002 (P591.02) can be mapped to a network register to transfer the set value as process date.
0x4027:009	Sequencer segment 2: Reserved 0 ... [0] ... 4294967295.0 • From version 03.00	
0x4028:001 (P803.01)	Sequencer segment 3: Frequency setpoint (Segment 3: Frequency setp.) -599.0 ... [0.0] ... 599.0 Hz • From version 03.00	Frequency setpoint for the segment. • Only relevant for operating mode 0x6060 (P301.00) = "MS: Velocity mode [-2]". • Direction of rotation according to sign.
0x4028:002 (P803.02)	Sequencer segment 3: Acceleration/deceleration (Segment 3: Accel./decel.) 0.0 ... [5.0] ... 3600.0 s • From version 03.00	Acceleration/deceleration for the segment. • Only relevant for operating mode 0x6060 (P301.00) = "MS: Velocity mode [-2]". • The set time refers to the acceleration from standstill to the set maximum frequency. The deceleration is effected with the same ramp.
0x4028:003 (P803.03)	Sequencer segment 3: Time (Segment 3: Time) 0.0 ... [0.0] ... 100000.0 s • From version 03.00	Runtime for the segment after the expiry of which it is switched over to the next step of the sequence. • Only relevant for Sequencer mode 0x4025 (P800.00) = "Time operation [1]" or "Time & step operation [3]". • With the setting "0.0", the segment will be skipped.

Configuring the frequency control

Configure setpoint sources
Sequencer



Address	Name / setting range / [default setting]	Information
0x4028:004 (P803.04)	Sequencer segment 3: Digital outputs (Segment 3: Digital outp.) 0 ... [0] ... 255 • From version 03.00	Optionally: Set digital outputs to the level set here for the execution time of the segment. Note! In order that the control of a digital output is executed by the sequencer, the following assignment must be made for the respective digital output: • Relay: 0x2634:001 (P420.01) = "Sequencer controlled [100]" • Digital output 1: 0x2634:002 (P420.02) = "Sequencer controlled [100]"
	Bit 0 Relay	0 = X9/NO-COM open and NC-COM closed. 1 = X9/NO-COM closed and NC-COM open. An inversion set in 0x2635:001 (P421.01) is taken into consideration here.
	Bit 1 Digital output 1	0 = set digital output 1 to LOW level. 1 = set digital output 1 to HIGH level. An inversion set in 0x2635:002 (P421.02) is taken into consideration here.
	Bit 2 Digital output 2	Function is not supported in this device.
0x4028:005 (P803.05)	Sequencer segment 3: Analog outputs (Segment 3: Analog outp.) 0.00 ... [0.00] ... 10.00 VDC • From version 03.00	Optionally: Set analog output to the voltage value set here for the execution time of the segment. Note! In order that the control of the analog output is executed by the sequencer, the following assignment must be made for the analog output: • Analog output 1: 0x2639:002 (P440.02) = "Sequencer controlled [10]"
0x4028:006 (P803.06)	Sequencer segment 3: PID setpoint (Segment 3: PID setp.) -300.00 ... [0.00] ... 300.00 PID unit • From version 03.00	PID control value for the segment. • Only relevant if the PID control in 0x4020:001 (P600.01) is activated.
0x4028:007 (P803.07)	Sequencer segment 3: Torque setpoint (Segment 3: Torque setp.) -400.0 ... [100.0] ... 400.0 % • From version 03.00	Torque setpoint for the segment. • Only relevant for operating mode 0x6060 (P301.00) = "MS: Torque mode [-1]".
0x4028:008	Sequencer segment 3: NetWordOUT2 0 ... [0] ... 65535 • From version 03.00	Optionally: Set the NetWordOUT2 data word to the value set here for the execution time of the segment. • The NetWordOUT2 data word 0x400A:002 (P591.02) can be mapped to a network register to transfer the set value as process date.
0x4028:009	Sequencer segment 3: Reserved 0 ... [0] ... 4294967295.0 • From version 03.00	
0x4029:001 (P804.01)	Sequencer segment 4: Frequency setpoint (Segment 4: Frequency setp.) -599.0 ... [0.0] ... 599.0 Hz • From version 03.00	Frequency setpoint for the segment. • Only relevant for operating mode 0x6060 (P301.00) = "MS: Velocity mode [-2]". • Direction of rotation according to sign.
0x4029:002 (P804.02)	Sequencer segment 4: Acceleration/deceleration (Segment 4: Accel./decel.) 0.0 ... [5.0] ... 3600.0 s • From version 03.00	Acceleration/deceleration for the segment. • Only relevant for operating mode 0x6060 (P301.00) = "MS: Velocity mode [-2]". • The set time refers to the acceleration from standstill to the set maximum frequency. The deceleration is effected with the same ramp.
0x4029:003 (P804.03)	Sequencer segment 4: Time (Segment 4: Time) 0.0 ... [0.0] ... 100000.0 s • From version 03.00	Runtime for the segment after the expiry of which it is switched over to the next step of the sequence. • Only relevant for Sequencer mode 0x4025 (P800.00) = "Time operation [1]" or "Time & step operation [3]". • With the setting "0.0", the segment will be skipped.



Configuring the frequency control

Configure setpoint sources
Sequencer

Address	Name / setting range / [default setting]	Information
0x4029:004 (P804.04)	Sequencer segment 4: Digital outputs (Segment 4: Digital outp.) 0 ... [0] ... 255 • From version 03.00	Optionally: Set digital outputs to the level set here for the execution time of the segment. Note! In order that the control of a digital output is executed by the sequencer, the following assignment must be made for the respective digital output: • Relay: 0x2634:001 (P420.01) = "Sequencer controlled [100]" • Digital output 1: 0x2634:002 (P420.02) = "Sequencer controlled [100]"
	Bit 0 Relay	0 = X9/NO-COM open and NC-COM closed. 1 = X9/NO-COM closed and NC-COM open. An inversion set in 0x2635:001 (P421.01) is taken into consideration here.
	Bit 1 Digital output 1	0 = set digital output 1 to LOW level. 1 = set digital output 1 to HIGH level. An inversion set in 0x2635:002 (P421.02) is taken into consideration here.
	Bit 2 Digital output 2	Function is not supported in this device.
0x4029:005 (P804.05)	Sequencer segment 4: Analog outputs (Segment 4: Analog outp.) 0.00 ... [0.00] ... 10.00 VDC • From version 03.00	Optionally: Set analog output to the voltage value set here for the execution time of the segment. Note! In order that the control of the analog output is executed by the sequencer, the following assignment must be made for the analog output: • Analog output 1: 0x2639:002 (P440.02) = "Sequencer controlled [10]"
0x4029:006 (P804.06)	Sequencer segment 4: PID setpoint (Segment 4: PID setp.) -300.00 ... [0.00] ... 300.00 PID unit • From version 03.00	PID control value for the segment. • Only relevant if the PID control in 0x4020:001 (P600.01) is activated.
0x4029:007 (P804.07)	Sequencer segment 4: Torque setpoint (Segment 4: Torque setp.) -400.0 ... [100.0] ... 400.0 % • From version 03.00	Torque setpoint for the segment. • Only relevant for operating mode 0x6060 (P301.00) = "MS: Torque mode [-1]".
0x4029:008	Sequencer segment 4: NetWordOUT2 0 ... [0] ... 65535 • From version 03.00	Optionally: Set the NetWordOUT2 data word to the value set here for the execution time of the segment. • The NetWordOUT2 data word 0x400A:002 (P591.02) can be mapped to a network register to transfer the set value as process date.
0x4029:009	Sequencer segment 4: Reserved 0 ... [0] ... 4294967295.0 • From version 03.00	
0x402A:001 (P805.01)	Sequencer segment 5: Frequency setpoint (Segment 5: Frequency setp.) -599.0 ... [0.0] ... 599.0 Hz • From version 03.00	Frequency setpoint for the segment. • Only relevant for operating mode 0x6060 (P301.00) = "MS: Velocity mode [-2]". • Direction of rotation according to sign.
0x402A:002 (P805.02)	Sequencer segment 5: Acceleration/deceleration (Segment 5: Accel./decel.) 0.0 ... [5.0] ... 3600.0 s • From version 03.00	Acceleration/deceleration for the segment. • Only relevant for operating mode 0x6060 (P301.00) = "MS: Velocity mode [-2]". • The set time refers to the acceleration from standstill to the set maximum frequency. The deceleration is effected with the same ramp.
0x402A:003 (P805.03)	Sequencer segment 5: Time (Segment 5: Time) 0.0 ... [0.0] ... 100000.0 s • From version 03.00	Runtime for the segment after the expiry of which it is switched over to the next step of the sequence. • Only relevant for Sequencer mode 0x4025 (P800.00) = "Time operation [1]" or "Time & step operation [3]". • With the setting "0.0", the segment will be skipped.

Configuring the frequency control

Configure setpoint sources Sequencer



Address	Name / setting range / [default setting]	Information
0x402A:004 (P805.04)	Sequencer segment 5: Digital outputs (Segment 5: Digital outp.) 0 ... [0] ... 255 • From version 03.00	Optionally: Set digital outputs to the level set here for the execution time of the segment. Note! In order that the control of a digital output is executed by the sequencer, the following assignment must be made for the respective digital output: • Relay: 0x2634:001 (P420.01) = "Sequencer controlled [100]" • Digital output 1: 0x2634:002 (P420.02) = "Sequencer controlled [100]"
	Bit 0 Relay	0 = X9/NO-COM open and NC-COM closed. 1 = X9/NO-COM closed and NC-COM open. An inversion set in 0x2635:001 (P421.01) is taken into consideration here.
	Bit 1 Digital output 1	0 = set digital output 1 to LOW level. 1 = set digital output 1 to HIGH level. An inversion set in 0x2635:002 (P421.02) is taken into consideration here.
	Bit 2 Digital output 2	Function is not supported in this device.
0x402A:005 (P805.05)	Sequencer segment 5: Analog outputs (Segment 5: Analog outp.) 0.00 ... [0.00] ... 10.00 VDC • From version 03.00	Optionally: Set analog output to the voltage value set here for the execution time of the segment. Note! In order that the control of the analog output is executed by the sequencer, the following assignment must be made for the analog output: • Analog output 1: 0x2639:002 (P440.02) = "Sequencer controlled [10]"
0x402A:006 (P805.06)	Sequencer segment 5: PID setpoint (Segment 5: PID setp.) -300.00 ... [0.00] ... 300.00 PID unit • From version 03.00	PID control value for the segment. • Only relevant if the PID control in 0x4020:001 (P600.01) is activated.
0x402A:007 (P805.07)	Sequencer segment 5: Torque setpoint (Segment 5: Torque setp.) -400.0 ... [100.0] ... 400.0 % • From version 03.00	Torque setpoint for the segment. • Only relevant for operating mode 0x6060 (P301.00) = "MS: Torque mode [-1]".
0x402A:008	Sequencer segment 5: NetWordOUT2 0 ... [0] ... 65535 • From version 03.00	Optionally: Set the NetWordOUT2 data word to the value set here for the execution time of the segment. • The NetWordOUT2 data word 0x400A:002 (P591.02) can be mapped to a network register to transfer the set value as process date.
0x402A:009	Sequencer segment 5: Reserved 0 ... [0] ... 4294967295.0 • From version 03.00	
0x402B:001 (P806.01)	Sequencer segment 6: Frequency setpoint (Segment 6: Frequency setp.) -599.0 ... [0.0] ... 599.0 Hz • From version 03.00	Frequency setpoint for the segment. • Only relevant for operating mode 0x6060 (P301.00) = "MS: Velocity mode [-2]". • Direction of rotation according to sign.
0x402B:002 (P806.02)	Sequencer segment 6: Acceleration/deceleration (Segment 6: Accel./decel.) 0.0 ... [5.0] ... 3600.0 s • From version 03.00	Acceleration/deceleration for the segment. • Only relevant for operating mode 0x6060 (P301.00) = "MS: Velocity mode [-2]". • The set time refers to the acceleration from standstill to the set maximum frequency. The deceleration is effected with the same ramp.
0x402B:003 (P806.03)	Sequencer segment 6: Time (Segment 6: Time) 0.0 ... [0.0] ... 100000.0 s • From version 03.00	Runtime for the segment after the expiry of which it is switched over to the next step of the sequence. • Only relevant for Sequencer mode 0x4025 (P800.00) = "Time operation [1]" or "Time & step operation [3]". • With the setting "0.0", the segment will be skipped.



Configuring the frequency control

Configure setpoint sources
Sequencer

Address	Name / setting range / [default setting]	Information
0x402B:004 (P806.04)	Sequencer segment 6: Digital outputs (Segment 6: Digital outp.) 0 ... [0] ... 255 • From version 03.00	Optionally: Set digital outputs to the level set here for the execution time of the segment. Note! In order that the control of a digital output is executed by the sequencer, the following assignment must be made for the respective digital output: • Relay: 0x2634:001 (P420.01) = "Sequencer controlled [100]" • Digital output 1: 0x2634:002 (P420.02) = "Sequencer controlled [100]"
	Bit 0 Relay	0 = X9/NO-COM open and NC-COM closed. 1 = X9/NO-COM closed and NC-COM open. An inversion set in 0x2635:001 (P421.01) is taken into consideration here.
	Bit 1 Digital output 1	0 = set digital output 1 to LOW level. 1 = set digital output 1 to HIGH level. An inversion set in 0x2635:002 (P421.02) is taken into consideration here.
	Bit 2 Digital output 2	Function is not supported in this device.
0x402B:005 (P806.05)	Sequencer segment 6: Analog outputs (Segment 6: Analog outp.) 0.00 ... [0.00] ... 10.00 VDC • From version 03.00	Optionally: Set analog output to the voltage value set here for the execution time of the segment. Note! In order that the control of the analog output is executed by the sequencer, the following assignment must be made for the analog output: • Analog output 1: 0x2639:002 (P440.02) = "Sequencer controlled [10]"
0x402B:006 (P806.06)	Sequencer segment 6: PID setpoint (Segment 6: PID setp.) -300.00 ... [0.00] ... 300.00 PID unit • From version 03.00	PID control value for the segment. • Only relevant if the PID control in 0x4020:001 (P600.01) is activated.
0x402B:007 (P806.07)	Sequencer segment 6: Torque setpoint (Segment 6: Torque setp.) -400.0 ... [100.0] ... 400.0 % • From version 03.00	Torque setpoint for the segment. • Only relevant for operating mode 0x6060 (P301.00) = "MS: Torque mode [-1]".
0x402B:008	Sequencer segment 6: NetWordOUT2 0 ... [0] ... 65535 • From version 03.00	Optionally: Set the NetWordOUT2 data word to the value set here for the execution time of the segment. • The NetWordOUT2 data word 0x400A:002 (P591.02) can be mapped to a network register to transfer the set value as process date.
0x402B:009	Sequencer segment 6: Reserved 0 ... [0] ... 4294967295.0 • From version 03.00	
0x402C:001 (P807.01)	Sequencer segment 7: Frequency setpoint (Segment 7: Frequency setp.) -599.0 ... [0.0] ... 599.0 Hz • From version 03.00	Frequency setpoint for the segment. • Only relevant for operating mode 0x6060 (P301.00) = "MS: Velocity mode [-2]". • Direction of rotation according to sign.
0x402C:002 (P807.02)	Sequencer segment 7: Acceleration/deceleration (Segment 7: Accel./decel.) 0.0 ... [5.0] ... 3600.0 s • From version 03.00	Acceleration/deceleration for the segment. • Only relevant for operating mode 0x6060 (P301.00) = "MS: Velocity mode [-2]". • The set time refers to the acceleration from standstill to the set maximum frequency. The deceleration is effected with the same ramp.
0x402C:003 (P807.03)	Sequencer segment 7: Time (Segment 7: Time) 0.0 ... [0.0] ... 100000.0 s • From version 03.00	Runtime for the segment after the expiry of which it is switched over to the next step of the sequence. • Only relevant for Sequencer mode 0x4025 (P800.00) = "Time operation [1]" or "Time & step operation [3]". • With the setting "0.0", the segment will be skipped.

Configuring the frequency control

Configure setpoint sources
Sequencer



Address	Name / setting range / [default setting]	Information
0x402C:004 (P807.04)	Sequencer segment 7: Digital outputs (Segment 7: Digital outp.) 0 ... [0] ... 255 • From version 03.00	Optionally: Set digital outputs to the level set here for the execution time of the segment. Note! In order that the control of a digital output is executed by the sequencer, the following assignment must be made for the respective digital output: • Relay: 0x2634:001 (P420.01) = "Sequencer controlled [100]" • Digital output 1: 0x2634:002 (P420.02) = "Sequencer controlled [100]"
	Bit 0 Relay	0 = X9/NO-COM open and NC-COM closed. 1 = X9/NO-COM closed and NC-COM open. An inversion set in 0x2635:001 (P421.01) is taken into consideration here.
	Bit 1 Digital output 1	0 = set digital output 1 to LOW level. 1 = set digital output 1 to HIGH level. An inversion set in 0x2635:002 (P421.02) is taken into consideration here.
	Bit 2 Digital output 2	Function is not supported in this device.
0x402C:005 (P807.05)	Sequencer segment 7: Analog outputs (Segment 7: Analog outp.) 0.00 ... [0.00] ... 10.00 VDC • From version 03.00	Optionally: Set analog output to the voltage value set here for the execution time of the segment. Note! In order that the control of the analog output is executed by the sequencer, the following assignment must be made for the analog output: • Analog output 1: 0x2639:002 (P440.02) = "Sequencer controlled [10]"
0x402C:006 (P807.06)	Sequencer segment 7: PID setpoint (Segment 7: PID setp.) -300.00 ... [0.00] ... 300.00 PID unit • From version 03.00	PID control value for the segment. • Only relevant if the PID control in 0x4020:001 (P600.01) is activated.
0x402C:007 (P807.07)	Sequencer segment 7: Torque setpoint (Segment 7: Torque setp.) -400.0 ... [100.0] ... 400.0 % • From version 03.00	Torque setpoint for the segment. • Only relevant for operating mode 0x6060 (P301.00) = "MS: Torque mode [-1]".
0x402C:008	Sequencer segment 7: NetWordOUT2 0 ... [0] ... 65535 • From version 03.00	Optionally: Set the NetWordOUT2 data word to the value set here for the execution time of the segment. • The NetWordOUT2 data word 0x400A:002 (P591.02) can be mapped to a network register to transfer the set value as process date.
0x402C:009	Sequencer segment 7: Reserved 0 ... [0] ... 4294967295.0 • From version 03.00	
0x402D:001 (P808.01)	Sequencer segment 8: Frequency setpoint (Segment 8: Frequency setp.) -599.0 ... [0.0] ... 599.0 Hz • From version 03.00	Frequency setpoint for the segment. • Only relevant for operating mode 0x6060 (P301.00) = "MS: Velocity mode [-2]". • Direction of rotation according to sign.
0x402D:002 (P808.02)	Sequencer segment 8: Acceleration/deceleration (Segment 8: Accel./decel.) 0.0 ... [5.0] ... 3600.0 s • From version 03.00	Acceleration/deceleration for the segment. • Only relevant for operating mode 0x6060 (P301.00) = "MS: Velocity mode [-2]". • The set time refers to the acceleration from standstill to the set maximum frequency. The deceleration is effected with the same ramp.
0x402D:003 (P808.03)	Sequencer segment 8: Time (Segment 8: Time) 0.0 ... [0.0] ... 100000.0 s • From version 03.00	Runtime for the segment after the expiry of which it is switched over to the next step of the sequence. • Only relevant for Sequencer mode 0x4025 (P800.00) = "Time operation [1]" or "Time & step operation [3]". • With the setting "0.0", the segment will be skipped.



Configuring the frequency control

Configure setpoint sources
Sequencer

Address	Name / setting range / [default setting]	Information
0x402D:004 (P808.04)	Sequencer segment 8: Digital outputs (Segment 8: Digital outp.) 0 ... [0] ... 255 • From version 03.00	Optionally: Set digital outputs to the level set here for the execution time of the segment. Note! In order that the control of a digital output is executed by the sequencer, the following assignment must be made for the respective digital output: • Relay: 0x2634:001 (P420.01) = "Sequencer controlled [100]" • Digital output 1: 0x2634:002 (P420.02) = "Sequencer controlled [100]"
	Bit 0 Relay	0 = X9/NO-COM open and NC-COM closed. 1 = X9/NO-COM closed and NC-COM open. An inversion set in 0x2635:001 (P421.01) is taken into consideration here.
	Bit 1 Digital output 1	0 = set digital output 1 to LOW level. 1 = set digital output 1 to HIGH level. An inversion set in 0x2635:002 (P421.02) is taken into consideration here.
	Bit 2 Digital output 2	Function is not supported in this device.
0x402D:005 (P808.05)	Sequencer segment 8: Analog outputs (Segment 8: Analog outp.) 0.00 ... [0.00] ... 10.00 VDC • From version 03.00	Optionally: Set analog output to the voltage value set here for the execution time of the segment. Note! In order that the control of the analog output is executed by the sequencer, the following assignment must be made for the analog output: • Analog output 1: 0x2639:002 (P440.02) = "Sequencer controlled [10]"
0x402D:006 (P808.06)	Sequencer segment 8: PID setpoint (Segment 8: PID setp.) -300.00 ... [0.00] ... 300.00 PID unit • From version 03.00	PID control value for the segment. • Only relevant if the PID control in 0x4020:001 (P600.01) is activated.
0x402D:007 (P808.07)	Sequencer segment 8: Torque setpoint (Segment 8: Torque setp.) -400.0 ... [100.0] ... 400.0 % • From version 03.00	Torque setpoint for the segment. • Only relevant for operating mode 0x6060 (P301.00) = "MS: Torque mode [-1]".
0x402D:008	Sequencer segment 8: NetWordOUT2 0 ... [0] ... 65535 • From version 03.00	Optionally: Set the NetWordOUT2 data word to the value set here for the execution time of the segment. • The NetWordOUT2 data word 0x400A:002 (P591.02) can be mapped to a network register to transfer the set value as process date.
0x402D:009	Sequencer segment 8: Reserved 0 ... [0] ... 4294967295.0 • From version 03.00	
0x402E:001 (P822.01)	End segment: Frequency setpoint (End segment: Frequency setp.) -599.0 ... [0.0] ... 599.0 Hz • From version 03.00	Frequency setpoint after the sequence has been completed, i. e., after the steps configured for the sequence have been passed through with the set numbers of cycles. • Only relevant for the operating mode 0x6060 (P301.00) = "MS: Velocity mode [-2]" and if end of sequence mode 0x402F (P824.00) = "Keep running [0]". • Direction of rotation according to sign.
0x402E:002 (P822.02)	End segment: Acceleration/deceleration (End segment: Accel./decel.) 0.0 ... [5.0] ... 3600.0 s • From version 03.00	If end of sequence mode = "continuous operation" (default setting): Acceleration/deceleration for reaching the frequency setpoint set for the end segment after the sequence has been processed. If end of sequence mode = "Stop" or "Stop and abort!": Deceleration for reaching standstill after the sequence has been processed. • Only relevant for operating mode 0x6060 (P301.00) = "MS: Velocity mode [-2]". • The set time refers to the acceleration from standstill to the set maximum frequency. The deceleration is effected with the same ramp.

Configuring the frequency control

Configure setpoint sources Sequencer



Address	Name / setting range / [default setting]	Information
0x402E:003 (P822.03)	End segment: Time (End segment: Time) 0.0 ... [0.0] ... 100000.0 s • From version 03.00	Delay time for activating the output states configured for the end segment. • This parameter has a different meaning than the time settings for the segments 1 ... 8! • The set deceleration time starts when the end segment is started to be processed. After the deceleration time has elapsed: • The digital output is set to the level set in 0x402E:004 (P822.04) (if configured accordingly). • The analog output is set to the voltage value set in 0x402E:005 (P822.05) (if configured accordingly). • The NetWordOUT2 data word is set to the value set in 0x402E:008 .
0x402E:004 (P822.04)	End segment: Digital outputs (End segment: Digital outp.) 0 ... [0] ... 255 • From version 03.00	Optionally: Set digital outputs to the levels set here after the time set for the end segment.
	Bit 0 Relay	0 = X9/NO-COM open and NC-COM closed. 1 = X9/NO-COM closed and NC-COM open. An inversion set in 0x2635:001 (P421.01) is taken into consideration here.
	Bit 1 Digital output 1	0 = set digital output 1 to LOW level. 1 = set digital output 1 to HIGH level. An inversion set in 0x2635:002 (P421.02) is taken into consideration here.
	Bit 2 Digital output 2	Function is not supported in this device.
0x402E:005 (P822.05)	End segment: Analog outputs (End segment: Analog outp.) 0.00 ... [0.00] ... 10.00 VDC • From version 03.00	Optionally: Set analog output to the voltage value set here after the time set for the end segment. Note! In order that the control of the analog output is executed by the sequencer, the following assignment must be made for the analog output: • Analog output 1: 0x2639:002 (P440.02) = "Sequencer controlled [10]"
0x402E:006 (P822.06)	End segment: PID setpoint (End segment: PID setp.) -300.00 ... [0.00] ... 300.00 PID unit • From version 03.00	PID control value after the sequence has been completed, i. e., after the steps configured for the sequence have been passed through with the set numbers of cycles. • Only relevant if PID control is activated in 0x4020:001 (P600.01) and end of sequence mode 0x402F (P824.00) = "Keep running [0]".
0x402E:007 (P822.07)	End segment: Torque setpoint (End segment: Torque setp.) -400.0 ... [100.0] ... 400.0 % • From version 03.00	Torque setpoint after the sequence has been completed, i. e., after the steps configured for the sequence have been passed through with the set numbers of cycles. • Only relevant for the operating mode 0x6060 (P301.00) = "MS: Torque mode [-1]" and if end of sequence mode 0x402F (P824.00) = "Keep running [0]".
0x402E:008	End segment: NetWordOUT2 0 ... [0] ... 65535 • From version 03.00	Optionally: Set NetWordOUT2 data word to the value set here after the time set for the end segment. • The NetWordOUT2 data word 0x400A:002 (P591.02) can be mapped to a network register to transfer the set value as process date.
0x402E:009	End segment: Reserved 0 ... [0] ... 4294967295.0 • From version 03.00	



Configuring the frequency control

Configure setpoint sources
Sequencer

7.2.4.2 Sequence configuration

Overall, sequences with the numbers 1 to 8 can be configured. Each sequence consists of 16 configurable steps. Each step of a sequence can call a segment or a complete sequence (with a higher number).

Details

The following example shows the configuration based on a nested sequence:

- The sequence 1 is the main sequence which calls further (sub) sequences.
- The main sequence is passed through four times. Afterwards, in the preset "continuous operation" end of sequence mode, the setpoint set for the end segment is continuously transmitted to the motor control until the sequence is aborted.

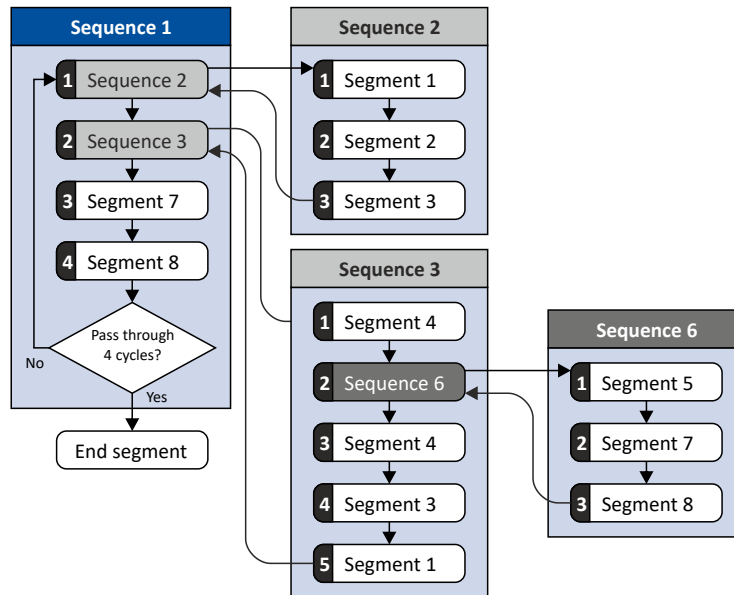

Resulting segment order												
1	2	3	4	5	7	8	4	3	1	7	8	End segment
4 cycles												

Required parameter setting:

	Sequence 1	Sequence 2
Step 1	0x4030:001 (P830.01) = "Sequence 2 [-2]"	0x4032:001 (P835.01) = "Segment 1 [1]"
Step 2	0x4030:002 (P830.02) = "Sequence 3 [-3]"	0x4032:002 (P835.02) = "Segment 2 [2]"
Step 3	0x4030:003 (P830.03) = "Segment 7 [7]"	0x4032:003 (P835.03) = "Segment 3 [3]"
Step 4	0x4030:004 (P830.04) = "Segment 8 [8]"	0x4032:004 (P835.04) = "Skip step [0]"
Step 5	0x4030:005 (P830.05) = "Skip step [0]"	...
Step
Step 16	0x4030:016 (P830.16) = "Skip step [0]"	0x4032:016 (P835.16) = "Skip step [0]"
Number of cycles	0x4031 (P831.00) = 4	0x4033 (P836.00) = 1

	Sequence 3	Sequence 6
Step 1	0x4034:001 (P840.01) = "Segment 4 [4]"	0x403A:001 (P855.01) = "Segment 5 [5]"
Step 2	0x4034:002 (P840.02) = "Sequence 6 [-6]"	0x403A:002 (P855.02) = "Segment 7 [7]"
Step 3	0x4034:003 (P840.03) = "Segment 4 [4]"	0x403A:003 (P855.03) = "Segment 8 [8]"
Step 4	0x4034:004 (P840.04) = "Segment 3 [3]"	0x403A:004 (P855.04) = "Skip step [0]"
Step 5	0x4034:005 (P840.05) = "Segment 1 [1]"	...
Step 6	0x4034:006 (P840.06) = "Skip step [0]"	...
Step
Step 16	0x4034:016 (P840.16) = "Skip step [0]"	0x403A:016 (P855.16) = "Skip step [0]"
Number of cycles	0x4035 (P841.00) = 1	0x403B (P856.00) = 1

Configuring the frequency control

Configure setpoint sources
Sequencer



In the following, all parameters relevant for the sequence configuration are given.



If the sequencer is active, write access to all parameters are blocked that concern the active sequence configuration!

Parameter

Address	Name / setting range / [default setting]	Information
0x4030:001 ... 0x4030:016 (P830.01 ... 16)	Sequence 1: Step 1 ... Step 16 (Sequence 1: Step 1 ... Step 16)	Configuration of the steps 1 ... 16 for sequence 1. <ul style="list-style-type: none"> Alternatively to calling a single segment, a complete sequence (with a higher number) can also be called from one step. This, for instance, serves to configure a main sequence from which several subsequences are called successively. With the setting "0", the respective step is skipped.
	-8 Sequence 8	
	-7 Sequence 7	
	-6 Sequence 6	
	-5 Sequence 5	
	-4 Sequence 4	
	-3 Sequence 3	
	-2 Sequence 2	
	0 Skip step	
	1 Segment 1	
	2 Segment 2	
	3 Segment 3	
	4 Segment 4	
	5 Segment 5	
6 Segment 6		
7 Segment 7		
8 Segment 8		
0x4031 (P831.00)	Number of cycles sequence 1 (Cycl. sequence 1) 1 ... [1] ... 65535 <ul style="list-style-type: none"> From version 03.00 	Definition of how often the sequence 1 is to be passed through. <ul style="list-style-type: none"> 1 = one pass, 2 = two passes, ... 65535 = infinite number of cycles.
0x4032:001 ... 0x4032:016 (P835.01 ... 16)	Sequence 2: Step 1 ... Step 16 (Sequence 2: Step 1 ... Step 16)	Configuration of the steps 1 ... 16 for sequence 2. <ul style="list-style-type: none"> Alternatively to calling a single segment, a complete sequence (with a higher number) can also be called from one step. This, for instance, serves to configure a main sequence from which several subsequences are called successively. With the setting "0", the respective step is skipped.
	-8 Sequence 8	
	-7 Sequence 7	
	-6 Sequence 6	
	-5 Sequence 5	
	-4 Sequence 4	
	-3 Sequence 3	
	0 Skip step	
	1 Segment 1	
	2 Segment 2	
	3 Segment 3	
	4 Segment 4	
	5 Segment 5	
	6 Segment 6	
7 Segment 7		
8 Segment 8		
0x4033 (P836.00)	Number of cycles sequence 2 (Cycl. sequence 2) 1 ... [1] ... 65535 <ul style="list-style-type: none"> From version 03.00 	Definition of how often the sequence 2 is to be passed through. <ul style="list-style-type: none"> 1 = one pass, 2 = two passes, ... 65535 = infinite number of cycles.



Configuring the frequency control

Configure setpoint sources
Sequencer

Address	Name / setting range / [default setting]	Information
0x4034:001 ... 0x4034:016 (P840.01 ... 16)	Sequence 3: Step 1 ... Step 16 (Sequence 3: Step 1 ... Step 16)	Configuration of the steps 1 ... 16 for sequence 3. <ul style="list-style-type: none"> Alternatively to calling a single segment, a complete sequence (with a higher number) can also be called from one step. This, for instance, serves to configure a main sequence from which several subsequences are called successively. With the setting "0", the respective step is skipped.
	-8 Sequence 8	
	-7 Sequence 7	
	-6 Sequence 6	
	-5 Sequence 5	
	-4 Sequence 4	
	0 Skip step	
	1 Segment 1	
	2 Segment 2	
	3 Segment 3	
4 Segment 4		
5 Segment 5		
6 Segment 6		
7 Segment 7		
8 Segment 8		
0x4035 (P841.00)	Number of cycles sequence 3 (Cycl. sequence 3) 1 ... [1] ... 65535 <ul style="list-style-type: none"> From version 03.00 	Definition of how often the sequence 3 is to be passed through. <ul style="list-style-type: none"> 1 = one pass, 2 = two passes, ... 65535 = infinite number of cycles.
0x4036:001 ... 0x4036:016 (P845.01 ... 16)	Sequence 4: Step 1 ... Step 16 (Sequence 4: Step 1 ... Step 16)	Configuration of the steps 1 ... 16 for sequence 4. <ul style="list-style-type: none"> Alternatively to calling a single segment, a complete sequence (with a higher number) can also be called from one step. This, for instance, serves to configure a main sequence from which several subsequences are called successively. With the setting "0", the respective step is skipped.
	-8 Sequence 8	
	-7 Sequence 7	
	-6 Sequence 6	
	-5 Sequence 5	
	0 Skip step	
	1 Segment 1	
	2 Segment 2	
	3 Segment 3	
	4 Segment 4	
5 Segment 5		
6 Segment 6		
7 Segment 7		
8 Segment 8		
0x4037 (P846.00)	Number of cycles sequence 4 (Cycl. sequence 4) 1 ... [1] ... 65535 <ul style="list-style-type: none"> From version 03.00 	Definition of how often the sequence 4 is to be passed through. <ul style="list-style-type: none"> 1 = one pass, 2 = two passes, ... 65535 = infinite number of cycles.
0x4038:001 ... 0x4038:016 (P850.01 ... 16)	Sequence 5: Step 1 ... Step 16 (Sequence 5: Step 1 ... Step 16)	Configuration of the steps 1 ... 16 for sequence 5. <ul style="list-style-type: none"> Alternatively to calling a single segment, a complete sequence (with a higher number) can also be called from one step. This, for instance, serves to configure a main sequence from which several subsequences are called successively. With the setting "0", the respective step is skipped.
	-8 Sequence 8	
	-7 Sequence 7	
	-6 Sequence 6	
	0 Skip step	
	1 Segment 1	
	2 Segment 2	
	3 Segment 3	
	4 Segment 4	
	5 Segment 5	
6 Segment 6		
7 Segment 7		
8 Segment 8		
0x4039 (P851.00)	Number of cycles sequence 5 (Cycl. sequence 5) 1 ... [1] ... 65535 <ul style="list-style-type: none"> From version 03.00 	Definition of how often the sequence 5 is to be passed through. <ul style="list-style-type: none"> 1 = one pass, 2 = two passes, ... 65535 = infinite number of cycles.

Configuring the frequency control

Configure setpoint sources
Sequencer



Address	Name / setting range / [default setting]	Information
0x403A:001 ... 0x403A:016 (P855.01 ... 16)	Sequence 6: Step 1 ... Step 16 (Sequence 6: Step 1 ... Step 16)	Configuration of the steps 1 ... 16 for sequence 6. <ul style="list-style-type: none"> Alternatively to calling a single segment, a complete sequence (with a higher number) can also be called from one step. This, for instance, serves to configure a main sequence from which several subsequences are called successively. With the setting "0", the respective step is skipped.
	-8 Sequence 8	
	-7 Sequence 7	
	0 Skip step	
	1 Segment 1	
	2 Segment 2	
	3 Segment 3	
	4 Segment 4	
	5 Segment 5	
	6 Segment 6	
7 Segment 7		
8 Segment 8		
0x403B (P856.00)	Number of cycles sequence 6 (Cycl. sequence 6) 1 ... [1] ... 65535 • From version 03.00	Definition of how often the sequence 6 is to be passed through. <ul style="list-style-type: none"> 1 = one pass, 2 = two passes, ... 65535 = infinite number of cycles.
0x403C:001 ... 0x403C:016 (P860.01 ... 16)	Sequence 7: Step 1 ... Step 16 (Sequence 7: Step 1 ... Step 16)	Configuration of the steps 1 ... 16 for sequence 7. <ul style="list-style-type: none"> Alternatively to calling a single segment, a complete sequence (with a higher number) can also be called from one step. This, for instance, serves to configure a main sequence from which several subsequences are called successively. With the setting "0", the respective step is skipped.
	-8 Sequence 8	
	0 Skip step	
	1 Segment 1	
	2 Segment 2	
	3 Segment 3	
	4 Segment 4	
	5 Segment 5	
	6 Segment 6	
	7 Segment 7	
8 Segment 8		
0x403D (P861.00)	Number of cycles sequence 7 (Cycl. sequence 7) 1 ... [1] ... 65535 • From version 03.00	Definition of how often the sequence 7 is to be passed through. <ul style="list-style-type: none"> 1 = one pass, 2 = two passes, ... 65535 = infinite number of cycles.
0x403E:001 ... 0x403E:016 (P865.01 ... 16)	Sequence 8: Step 1 ... Step 16 (Sequence 8: Step 1 ... Step 16)	Configuration of the steps 1 ... 16 for sequence 8. <ul style="list-style-type: none"> With the setting "0", the respective step is skipped.
	0 Skip step	
	1 Segment 1	
	2 Segment 2	
	3 Segment 3	
	4 Segment 4	
	5 Segment 5	
	6 Segment 6	
	7 Segment 7	
	8 Segment 8	
0x403F (P866.00)	Number of cycles sequence 8 (Cycl. sequence 8) 1 ... [1] ... 65535 • From version 03.00	Definition of how often the sequence 8 is to be passed through. <ul style="list-style-type: none"> 65535 = infinite number of cycles.



7.2.4.3 Sequencer basic settings

The sequencer is inhibited by default. The desired sequencer mode (time, step or time-step mode) must first be selected in order for the sequencer to be enabled. The sequence start mode and the sequence end mode must also be set. There are different modes to choose from here.

Details

Sequencer mode **0x4025 (P800.00)**

- The sequencer can be operated in time, step or time-step operation.
- The following diagram demonstrates the different sequencer modes:

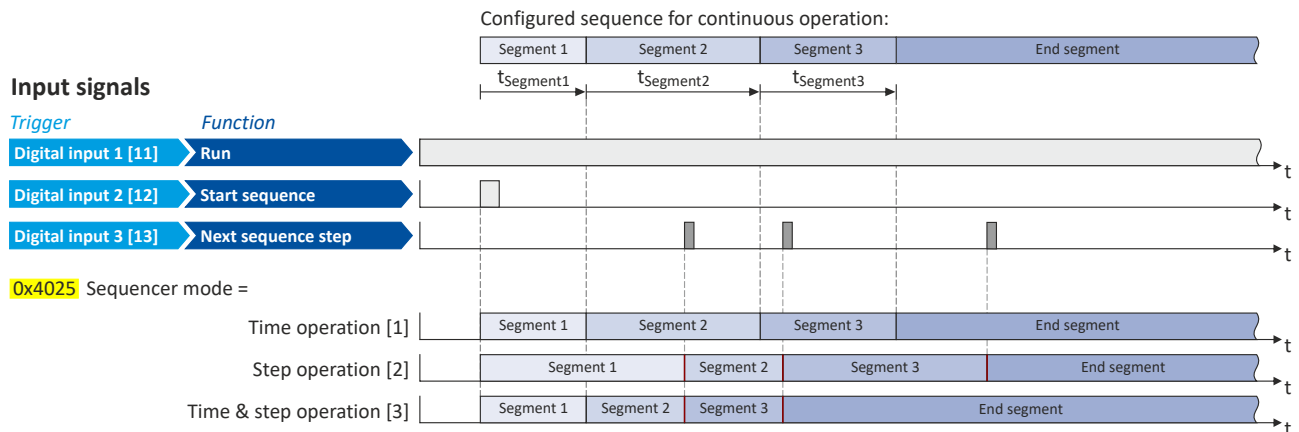

End of sequence mode **0x402F (P824.00)**

- The end of sequence mode defines the action after the end of the sequence.
- In the default setting "Keep running [0]", the setpoint set for the end segment is continuously transmitted to the motor control until the sequence is aborted.
- The following diagram demonstrates the different end of sequence modes:

Input signals

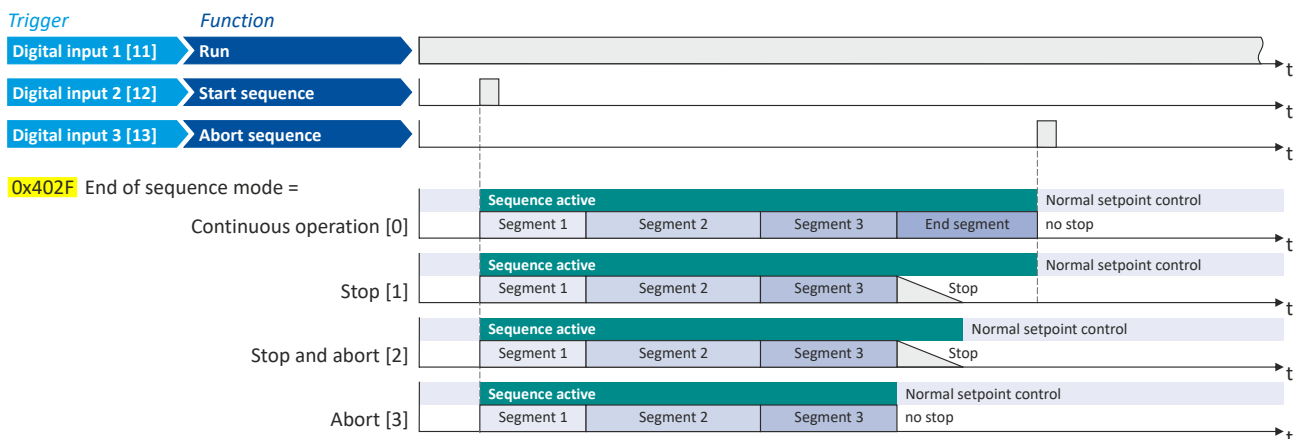

Configuring the frequency control

Configure setpoint sources
Sequencer



Start of sequence mode [0x4040 \(P820.00\)](#)

- The start of sequence mode defines the action after the motor is stopped and restarted or after the motor has been restarted after an error occurred.
- In the default setting "Restart sequencer [0]", the currently selected sequence is restarted.
- The following diagram demonstrates the different start of sequence modes:

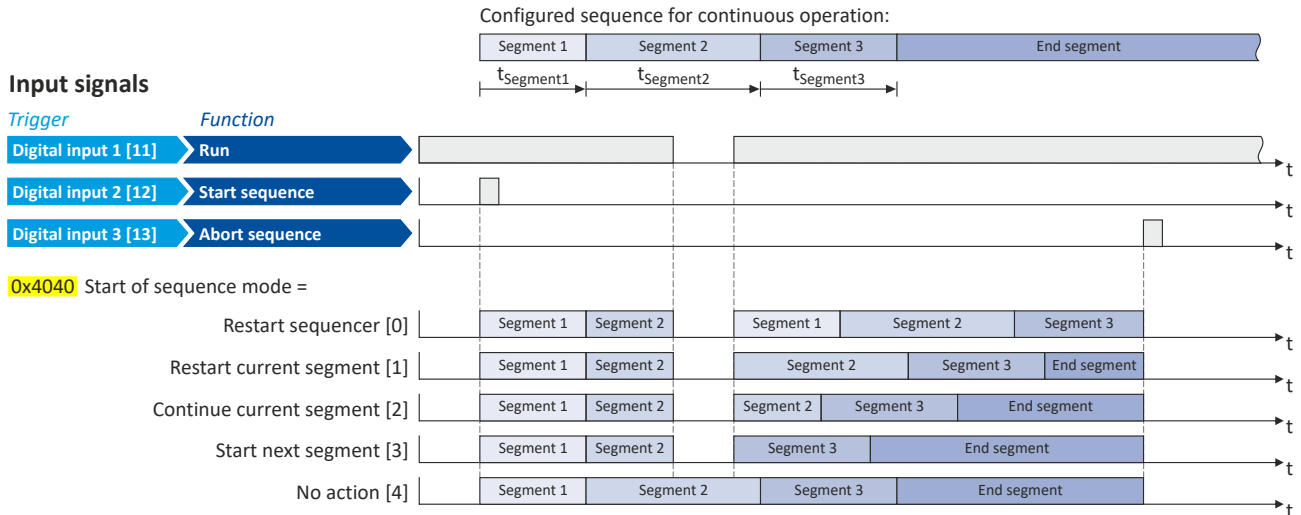

Parameter

Address	Name / setting range / [default setting]	Information
0x4025 (P800.00)	Sequencer mode (Sequencer mode) • From version 02.00	Selection of the sequencer mode.
	0 Disabled	
	1 Time operation (from version 03.00)	The switch-over to the next step of the sequence is made after the time set for the current segment has elapsed.
	2 Step operation (from version 03.00)	The switch-over to the next step of the sequence is made via the trigger assigned in 0x2631:032 (P400.32) to the "Next sequence step" function.
	3 Time & step operation (from version 03.00)	The switch-over to the next step of the sequence is made via the trigger assigned in 0x2631:032 (P400.32) to the "Next sequence step" function, but no later than after the time set for the current segment has elapsed.
0x402F (P824.00)	End of sequence mode (End of seq. mode) • From version 03.00	Selection of the action after the sequence has been completed, i. e., after the steps configured for the sequence have been passed through with the set numbers of cycles.
	0 Keep running	The setpoint set for the end segment is continuously transmitted to the motor control until the sequence is aborted.
	1 Stop	The motor is stopped with the stop method set in 0x2838:003 (P203.03) . The setpoint is continued to be controlled by the sequencer. In order to return to the normal setpoint control, the sequence must be aborted. Note! After returning to the normal setpoint control, a start command is required to restart the motor.
	2 Stop and abort	The motor is stopped with the stop method set in 0x2838:003 (P203.03) . After standstill is reached, it is automatically returned to the normal setpoint control. Note! After returning to the normal setpoint control, a start command is required to restart the motor.
	3 Abort	Return to the normal setpoint control without stopping the motor.



Configuring the frequency control

Configure setpoint sources
Sequencer

Address	Name / setting range / [default setting]	Information
0x4040 (P820.00)	Start of sequence mode (StartOfSeq. mode) • From version 03.00	Selection of the action after the motor has been stopped and restarted or after the motor has been restarted after an error occurred.
	0 Restart sequencer	The currently selected sequence is restarted.
	1 Restart current segment	The current segment of the selected sequence is restarted.
	2 Continue current segment	The current segment of the selected sequence is continued (just like after a break).
	3 Start next segment	The next segment of the selected sequence is started.
4 No action	For debugging purposes: The sequence is continued to be processed (including output states) even if the motor is stopped.	

Configuring the frequency control

Configure setpoint sources
Sequencer



7.2.4.4 Sequencer control functions

The following functions serve to control the sequencer. ▶ [Sequencer](#) 87

Select sequence

A sequence is selected in a binary-coded fashion via the triggers assigned to the four functions "Select sequence (bit 0)" ... "Select sequence (bit 3)" in compliance with the following truth table:

Select sequence				Selection
Bit 3 0x2631:053 (P400.53)	Bit 2 0x2631:052 (P400.52)	Bit 1 0x2631:051 (P400.51)	Bit 0 0x2631:050 (P400.50)	
FALSE	FALSE	FALSE	FALSE	No sequence selected
FALSE	FALSE	FALSE	TRUE	Sequence 1
FALSE	FALSE	TRUE	FALSE	Sequence 2
FALSE	FALSE	TRUE	TRUE	Sequence 3
FALSE	TRUE	FALSE	FALSE	Sequence 4
FALSE	TRUE	FALSE	TRUE	Sequence 5
FALSE	TRUE	TRUE	FALSE	Sequence 6
FALSE	TRUE	TRUE	TRUE	Sequence 7
TRUE	FALSE	FALSE	FALSE	Sequence 8
TRUE	FALSE	FALSE	TRUE	Invalid selection
...				
TRUE	TRUE	TRUE	TRUE	

Start sequence

The selected sequence is not started automatically. For starting the sequence, two functions are available:

- [0x2631:030 \(P400.30\)](#): Run/abort sequence (status-controlled start)
- [0x2631:031 \(P400.31\)](#): Start sequence (edge-controlled start)

Further control functions

The following functions serve to control the started sequence:

- [0x2631:032 \(P400.32\)](#): Next sequence step
- [0x2631:033 \(P400.33\)](#): Pause sequence
- [0x2631:034 \(P400.34\)](#): Suspend sequence
- [0x2631:035 \(P400.35\)](#): Stop sequence
- [0x2631:036 \(P400.36\)](#): Abort sequence

For controlling the sequencer via the network, the sequencer control functions can also be assigned to the NetWordIN1 data word [0x4008:001 \(P590.01\)](#).

Parameter

Address	Name / setting range / [default setting]	Information
0x2631:030 (P400.30)	Function list: Run/abort sequence (Function list: Seq: Run/abort)	Assignment of a trigger for the "Run/abort sequence" function. Trigger = TRUE: Start selected sequence. Trigger = FALSE: Abort sequence. Notes: • The assigned trigger must remain set to TRUE for the duration of the sequence. • If the trigger bit is reset to FALSE, the sequence is aborted. In this case, the standard setpoint or the setpoint source selected via setpoint change-over is active again. • A sequence is selected in a binary-coded fashion via the trigger assigned to the four functions "Select sequence (bit 0)" 0x2631:050 (P400.50) ... "Select sequence (bit 3)" 0x2631:053 (P400.53) . • For an edge-controlled start, the function "Start sequence" 0x2631:031 (P400.31) is optionally available.
	• Setting can only be changed if the inverter is disabled. • From version 03.00 • Further possible settings: ▶ Trigger list 59	
	0 Not connected	No trigger assigned (trigger is constantly FALSE).



Configuring the frequency control

Configure setpoint sources
Sequencer

Address	Name / setting range / [default setting]	Information
0x2631:031 (P400.31)	Function list: Start sequence (Function list: Seq: Start) <ul style="list-style-type: none"> Setting can only be changed if the inverter is disabled. From version 03.00 Further possible settings: ▶ Trigger list 59 	Assignment of a trigger for the "Start sequence" function. Trigger = FALSE \nearrow TRUE (edge): Start selected sequence. Trigger = TRUE \searrow FALSE (edge): No action. Notes: <ul style="list-style-type: none"> After the start, the sequencer remains activated until the function "Stop sequence" 0x2631:035 (P400.35) or the function "Abort sequence" 0x2631:036 (P400.36) is executed. A normal stop command does not reset the start command for the sequencer. For a status-controlled start, the function "Run/abort sequence" 0x2631:030 (P400.30) is optionally available.
	0 Not connected	No trigger assigned (trigger is constantly FALSE).
0x2631:032 (P400.32)	Function list: Next sequence step (Function list: Seq: Next step) <ul style="list-style-type: none"> Setting can only be changed if the inverter is disabled. From version 03.00 Further possible settings: ▶ Trigger list 59 	Assignment of a trigger for the "Next sequence step" function. Trigger = FALSE \nearrow TRUE (edge): Next sequence step. Trigger = TRUE \searrow FALSE (edge): No action. Notes: <ul style="list-style-type: none"> The execution of the current step is completed even if the time parameterised for the segment has not elapsed yet. The function is only relevant for Sequencer mode 0x4025 (P800.00) = "Step operation [2]" or "Time & step operation [3]". A jump to the next sequence step is not possible if the sequence pauses, the sequence is suspended or the final segment is executed.
	0 Not connected	No trigger assigned (trigger is constantly FALSE).
0x2631:033 (P400.33)	Function list: Pause sequence (Function list: Seq: Pause) <ul style="list-style-type: none"> Setting can only be changed if the inverter is disabled. From version 03.00 Further possible settings: ▶ Trigger list 59 	Assignment of a trigger for the "Pause sequence" function. Trigger = TRUE: Pause sequence. Trigger = FALSE: Continue sequence. Notes: <ul style="list-style-type: none"> During the pause, the sequence stops in the current step. The expiration of the time set for the segment is stopped. The sequencer setpoint continues to remain active.
	0 Not connected	No trigger assigned (trigger is constantly FALSE).
0x2631:034 (P400.34)	Function list: Suspend sequence (Function list: Seq: Suspense) <ul style="list-style-type: none"> Setting can only be changed if the inverter is disabled. From version 03.00 Further possible settings: ▶ Trigger list 59 	Assignment of a trigger for the "Suspend sequence" function. Trigger = TRUE: Suspend sequence. Trigger = FALSE: Continue sequence. Notes: <ul style="list-style-type: none"> This function serves to temporarily change over to the standard setpoint or the setpoint source selected via setpoint change-over. The sequence is continued at the point where it was suspended.
	0 Not connected	No trigger assigned (trigger is constantly FALSE).
0x2631:035 (P400.35)	Function list: Stop sequence (Function list: Seq: Stop) <ul style="list-style-type: none"> Setting can only be changed if the inverter is disabled. From version 03.00 Further possible settings: ▶ Trigger list 59 	Assignment of a trigger for the "Stop sequence" function. Trigger = FALSE \nearrow TRUE (edge): Stop sequence. Trigger = TRUE \searrow FALSE (edge): No action. Notes: <ul style="list-style-type: none"> If the sequence is stopped, it is jumped to the final segment. The further execution depends on the selected End of sequence mode 0x402F (P824.00).
	0 Not connected	No trigger assigned (trigger is constantly FALSE).
0x2631:036 (P400.36)	Function list: Abort sequence (Function list: Seq: Abort) <ul style="list-style-type: none"> Setting can only be changed if the inverter is disabled. From version 03.00 Further possible settings: ▶ Trigger list 59 	Assignment of a trigger for the "Abort sequence" function. Trigger = FALSE \nearrow TRUE (edge): Abort sequence. Trigger = TRUE \searrow FALSE (edge): No action. Notes: <ul style="list-style-type: none"> This function serves to directly stop the sequence without the final segment being executed. In this case, the standard setpoint or the setpoint source selected via setpoint change-over is active again.
	0 Not connected	No trigger assigned (trigger is constantly FALSE).

Configuring the frequency control

Configure setpoint sources Sequencer



Address	Name / setting range / [default setting]	Information
0x2631:050 (P400.50)	Function list: Select sequence (bit 0) (Function list: Seq: Select. b0) <ul style="list-style-type: none"> Setting can only be changed if the inverter is disabled. From version 03.00 Further possible settings: ▶ Trigger list 59 	Assignment of a trigger for the "Select sequence (bit 0)" function. Selection bit with the valency 2^0 for bit coded selection of a sequence. Trigger = FALSE: selection bit = "0". Trigger = TRUE: selection bit = "1". Notes: <ul style="list-style-type: none"> The selected sequence is not started automatically. For a status-controlled start, the function "Run/abort sequence" 0x2631:030 (P400.30) is available. For an edge-controlled start, the function "Start sequence" 0x2631:031 (P400.31) is available.
	0 Not connected	No trigger assigned (trigger is constantly FALSE).
0x2631:051 (P400.51)	Function list: Select sequence (bit 1) (Function list: Seq: Select. b1) <ul style="list-style-type: none"> Setting can only be changed if the inverter is disabled. From version 03.00 Further possible settings: ▶ Trigger list 59 	Assignment of a trigger for the "Select sequence (bit 1)" function. Selection bit with the valency 2^1 for the bit-coded selection of a sequence. Trigger = FALSE: selection bit = "0". Trigger = TRUE: selection bit = "1". Notes: <ul style="list-style-type: none"> The selected sequence is not started automatically. For a status-controlled start, the function "Run/abort sequence" 0x2631:030 (P400.30) is available. For an edge-controlled start, the function "Start sequence" 0x2631:031 (P400.31) is available.
	0 Not connected	No trigger assigned (trigger is constantly FALSE).
0x2631:052 (P400.52)	Function list: Select sequence (bit 2) (Function list: Seq: Select. b2) <ul style="list-style-type: none"> Setting can only be changed if the inverter is disabled. From version 03.00 Further possible settings: ▶ Trigger list 59 	Assignment of a trigger for the "Select sequence (bit 2)" function. Selection bit with the valency 2^2 for the bit-coded selection of a sequence. Trigger = FALSE: selection bit = "0". Trigger = TRUE: selection bit = "1". Notes: <ul style="list-style-type: none"> The selected sequence is not started automatically. For a status-controlled start, the function "Run/abort sequence" 0x2631:030 (P400.30) is available. For an edge-controlled start, the function "Start sequence" 0x2631:031 (P400.31) is available.
	0 Not connected	No trigger assigned (trigger is constantly FALSE).
0x2631:053 (P400.53)	Function list: Select sequence (bit 3) (Function list: Seq: Select. b3) <ul style="list-style-type: none"> Setting can only be changed if the inverter is disabled. From version 03.00 Further possible settings: ▶ Trigger list 59 	Assignment of a trigger for the "Select sequence (bit 3)" function. Selection bit with the valency 2^3 for the bit-coded selection of a sequence. Trigger = FALSE: selection bit = "0". Trigger = TRUE: selection bit = "1". Notes: <ul style="list-style-type: none"> The selected sequence is not started automatically. For a status-controlled start, the function "Run/abort sequence" 0x2631:030 (P400.30) is available. For an edge-controlled start, the function "Start sequence" 0x2631:031 (P400.31) is available.
	0 Not connected	No trigger assigned (trigger is constantly FALSE).



Configuring the frequency control

Configure setpoint sources
Sequencer

Example for operating mode

In the following example, the digital inputs 2 and 3 are used for controlling the sequencer.

- The analog input 1 is set as standard setpoint source.
- The switch S1 starts the motor in forward rotating direction. The switch S1 in the initial position stops the motor again.
- The button S2 starts the sequence, the button S3 aborts the sequence. After the abortion, the normal setpoint control is active again.

Connection plan	Function	
	Potentiometer R1	Frequency setpoint selection
	Switch S1	Run
	Button S2	Start sequence
	Button S3	Abort sequence

Parameter	Name	Setting for this example
0x2631:001 (P400.01)	Enable inverter	Constant TRUE [1]
0x2631:002 (P400.02)	Run	Digital input 1 [11]
0x2631:004 (P400.04)	Reset fault	Not connected [0]
0x2631:013 (P400.13)	Reverse rotational direction	Not connected [0]
0x2631:031 (P400.31)	Start sequence	Digital input 2 [12]
0x2631:036 (P400.36)	Abort sequence	Digital input 3 [13]
0x2631:050 (P400.50)	Select sequence (bit 0)	Constant TRUE [1]
0x2634:001 (P420.01)	Relay	Sequencer controlled [100]
0x2634:002 (P420.02)	Digital output 1	Sequencer controlled [100]

Segment and sequence configuration

In this example, only the sequence 1 is used. The sequence consists of two steps (segment 1 and segment 2).

0x4026:001 (P801.01)	Sequencer segment 1: Frequency setpoint	40 Hz
0x4026:002 (P801.02)	Sequencer segment 1: Acceleration/deceleration	20 s
0x4026:003 (P801.03)	Sequencer segment 1: Time	18 s
0x4026:004 (P801.04)	Sequencer segment 1: Digital outputs	0x00
0x4027:001 (P802.01)	Sequencer segment 2: Frequency setpoint	30 Hz
0x4027:002 (P802.02)	Sequencer segment 2: Acceleration/deceleration	15 s
0x4027:003 (P802.03)	Sequencer segment 2: Time	14 s
0x4027:004 (P802.04)	Sequencer segment 2: Digital outputs	0x02 (only relay)
0x402E:001 (P822.01)	End segment: Frequency setpoint	10 Hz
0x402E:002 (P822.02)	End segment: Acceleration/deceleration	8 s
0x402E:003 (P822.03)	End segment: Time	10 s
0x402E:004 (P822.04)	End segment: Digital outputs	0x04 (only digital output 1)
0x4030:001 ... 0x4030:016 (P830.01 ... 16)	Sequence 1: Step 1	Segment 1 [1]
	Sequence 1: Step 2	Segment 2 [2]
	Sequence 1: Step 3	Skip step [0]

	Sequence 1: Step 16	Skip step [0]

Sequencer basic settings

0x4025 (P800.00)	Sequencer mode	Time operation [1]
0x402F (P824.00)	End of sequence mode	Keep running [0]
0x4040 (P820.00)	Start of sequence mode	Restart sequencer [0]

Configuring the frequency control

Configure setpoint sources
Sequencer



Input signals

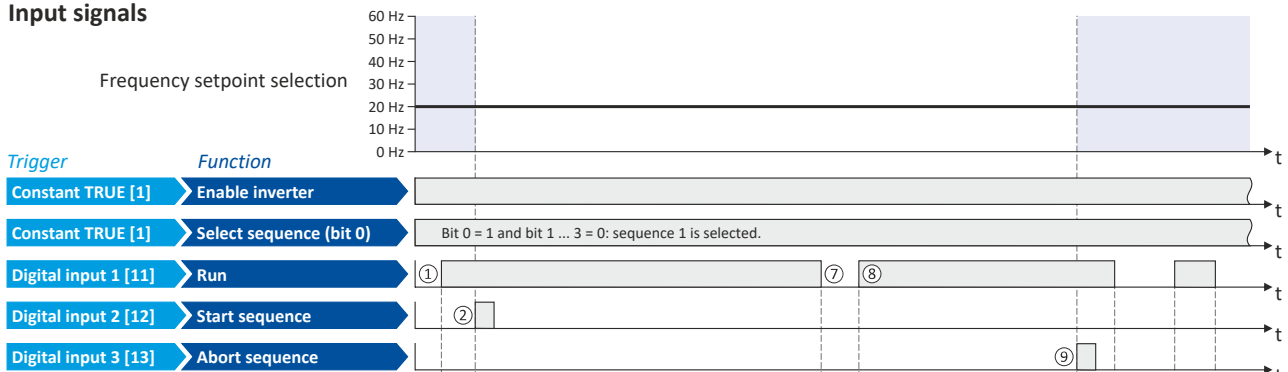

Output signals

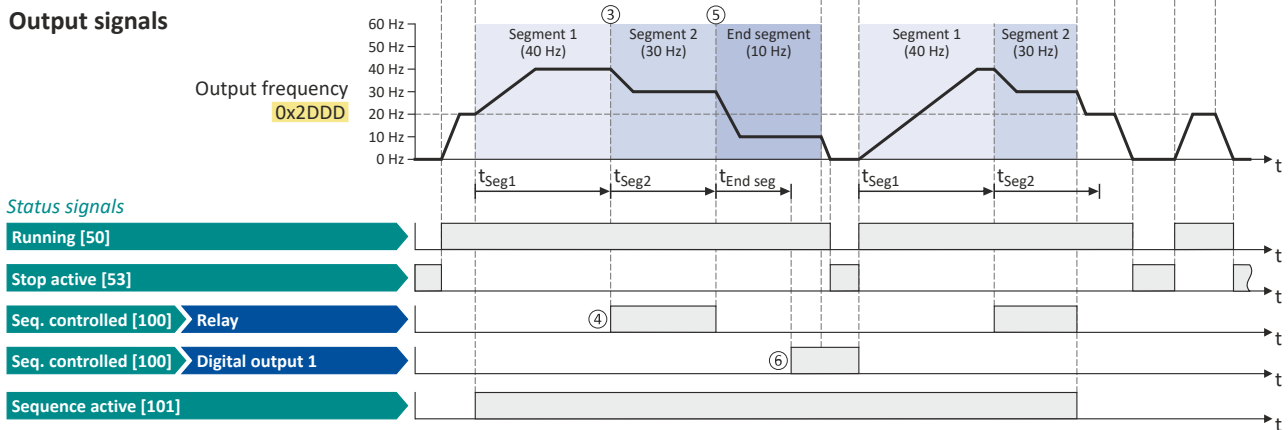

The status signals can be assigned to digital outputs. ▶ [Configure digital outputs](#) 247

- If the inverter is enabled and no error is active, the motor can be started with the "Run" function. As the sequence has not been started yet, first the normal setpoint control is active.
- ② The "Start sequence" function is used to start the selected sequence in an edge-controlled way.
- ③ Sequencer mode `0x4025 (P800.00)` = "Time operation [1]":
The switch-over to the next step of the sequence is made after the time set for the current segment has elapsed.
- ④ The segment 2 is configured here in such a way that the relay will be triggered during the time of processing.
- ⑤ End of sequence mode `0x402F (P824.00)` = "Keep running [0]":
After the sequence has been processed, the setpoint set for the end segment is continuously transmitted to the motor control until the sequence is aborted.
- ⑥ In case of the end segment, the time setting determines the delay after which the configured output states are to become active. Here, the end segment is configured in such a way that the digital output 1 is set after 10 s have expired.
- ④ If the "Run" function is set to FALSE, the motor is stopped with the stop method set in `0x2838:003 (P203.03)`. The started sequence, however, remains active and the sequencer-controlled outputs keep their state.
- ③ Start of sequence mode `0x4040 (P820.00)` = "Restart sequencer [0]":
If the "Run" function is set to TRUE again, the (still active) sequence is restarted.
- ④ The "Abort sequence" function is used to abort the sequence in an edge-controlled way.
In this case, the standard setpoint or the setpoint source selected via setpoint change-over is active again.

7.2.4.5 Sequencer diagnostics

The following parameters serve to diagnose the "sequencer" function.

Parameter

Address	Name / setting range / [default setting]	Information
0x2DAE:001 (P140.01)	Sequencer diagnostics: Active step (Sequencer diag: Active Step) • Read only • From version 03.00	Display of the active step. • 0 = no sequence active.
0x2DAE:002 (P140.02)	Sequencer diagnostics: Step time elapsed (Sequencer diag: StepTime elapsed) • Read only: x.x s • From version 03.00	Display of the time that has passed since the start of the current step.



Configuring the frequency control

Configure setpoint sources
Sequencer

Address	Name / setting range / [default setting]	Information
0x2DAE:003 (P140.03)	Sequencer diagnostics: Step time remaining (Sequencer diag: StepTime remain) <ul style="list-style-type: none"> • Read only: x.x s • From version 03.00 	Display of the remaining time for the current step.
0x2DAE:004 (P140.04)	Sequencer diagnostics: Steps complete (Sequencer diag: Steps complete) <ul style="list-style-type: none"> • Read only • From version 03.00 	Display of the number of steps that have been made since the start of the sequence.
0x2DAE:005 (P140.05)	Sequencer diagnostics: Steps remaining (Sequencer diag: Steps remain) <ul style="list-style-type: none"> • Read only • From version 03.00 	Display of the remaining number of steps until the current sequence is completed. This includes the current step.
0x2DAE:006 (P140.06)	Sequencer diagnostics: Active sequence (Sequencer diag: Active sequence) <ul style="list-style-type: none"> • Read only • From version 03.00 	Display of the active sequence. <ul style="list-style-type: none"> • 0 = no sequence active.
0x2DAE:007 (P140.07)	Sequencer diagnostics: Active segment (Sequencer diag: Active segment) <ul style="list-style-type: none"> • Read only • From version 03.00 	Display of the active segment. <ul style="list-style-type: none"> • 0 = no sequence active. • 255 = final sequence active.
0x2DAE:008 (P140.08)	Sequencer diagnostics: Relative sequence time remaining (Sequencer diag: SeqTime remain %) <ul style="list-style-type: none"> • Read only: x % • From version 03.00 	Display of the remaining time of the sequence in [%].
0x2DAE:009 (P140.09)	Sequencer diagnostics: Absolute sequence time remaining (Sequencer diag: SeqTime remain) <ul style="list-style-type: none"> • Read only: x.x s • From version 03.00 	Display of the remaining time of the sequence in [s].
0x2DAE:010	Sequencer diagnostics: Frequency setpoint <ul style="list-style-type: none"> • Read only: x.x Hz • From version 03.00 	Display of the current frequency setpoint of the "sequencer" function.
0x2DAE:011	Sequencer diagnostics: PID setpoint <ul style="list-style-type: none"> • Read only: x.xx PID unit • From version 03.00 	Display of the current PID control value of the "sequencer" function.
0x2DAE:012	Sequencer diagnostics: Torque setpoint <ul style="list-style-type: none"> • Read only: x.x % • From version 03.00 	Display of the current torque setpoints of the "sequencer" function. <ul style="list-style-type: none"> • 100 % = Rated motor torque 0x6076 (P325.00)

Configuring the frequency control

Configuring the process controller



7.3 Configuring the process controller

By means of the process controller, a process variable can be regulated, for instance the pressure of a pump. The process controller is also referred to as "PID controller" (PID controller = proportional, integral and differential controller).

The process controller is part of a closed control loop. The variable to be influenced (controlled variable) is measured continuously by means of a sensor and supplied to the inverter as an analog signal (actual value) which, in the inverter, is then compared to the reference value (setpoint). The system deviation resulting therefrom is supplied to the process controller which, on this basis, decelerates or accelerates the motor speed according to the desired dynamic performance of the control loop, so that, for instance, a pump always generates the desired pressure.

Connection plan (example)

The following sample connection plan shows the control of a pump ①. The feedback of the variable (here: pressure) takes place via a pressure transducer ② connected to the analog input 1.

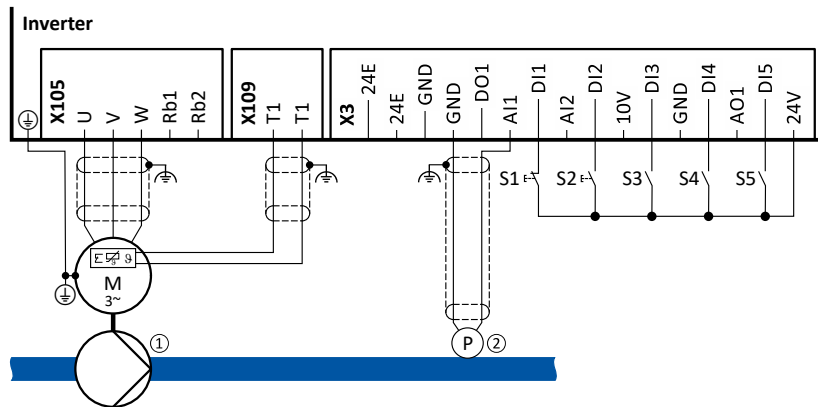

The digital inputs can be used to activate functions of the process controller. The specific assignment of the digital inputs and type of the contacts (switches or buttons, normally-closed contacts or normally-open contacts) depends on the application.

General information on the setting

- First implement the basic setting of the frequency control. ▶ [Basic setting](#) 78
- The basic setting of the process controller is described in the following subchapter.
▶ [Basic setting](#) 113
- Optionally, the motor can be put into an energy-saving sleep mode if no power is required.
▶ [Process controller sleep mode](#) 119
- The rinsing function which can be activated in addition accelerates the motor in idle state to a defined speed at regular intervals. The rinsing of a pipe system with a pump that has been in an inactive state for a longer period is a typical application. ▶ [Process controller rinse function](#) 121



7.3.1 Basic setting

The process controller is set in two steps:

1. Basic settings
2. Fine adjustment of the PID controller for an optimum control mode

Basic settings

Based on the default setting, we recommend the following proceeding:

1. Select the standard setpoint source for the frequency control in [0x2860:001 \(P201.01\)](#).
2. Configure the selected standard setpoint source. ▶ [Configure setpoint sources](#) [□ 82](#)
3. Activate the PID control. Set the desired operating mode (normal or reverse operation) in [0x4020:001 \(P600.01\)](#).
4. If the feedback of the variable is to take place via analog input 2 instead of analog input 1: Set [0x4020:002 \(P600.02\)](#) = "analog input 2 [2]".
5. Configure the analog input used:
 - Configure the input range.
 - Configure the setting range for the PID control.
 - Adapt the filter time to minimise the impact of noise on the control variable.
 - Set the monitoring response to "No response [0]".
▶ [Configure analog inputs](#) [□ 240](#)
6. If a (temporary) change-over to a speed-controlled operation is to be possible via a digital input:
 - Assign a free digital input to the control function "Deactivate PID controller" in [0x2631:045 \(P400.45\)](#). As long as the digital input provides a TRUE signal, the PID control is ignored and the motor is driven in a speed-controlled way.
 - Set acceleration time [0x4021:001 \(P606.01\)](#) and deceleration time [0x4021:002 \(P606.02\)](#) for speed-controlled drive control.
7. Select the standard setpoint source for the reference value in [0x2860:002 \(P201.02\)](#).
 - Functions for setpoint change-over can be used as well. ▶ [Changing the setpoint source during operation](#) [□ 125](#)
 - The keypad setpoint can be preset in [0x2601:002 \(P202.02\)](#).
 - If process controller presets are used, they have to be set in [0x4022:001 \(P451.01\)](#) ... [0x4022:008 \(P451.08\)](#).
 - If the analog input is used as setpoint source, it must be configured accordingly.
▶ [Configure analog inputs](#) [□ 240](#)
 - If the motor potentiometer is used as setpoint source, this function must be configured accordingly. ▶ [Motor potentiometer \(MOP\)](#) [□ 85](#)
8. Set the speed range to be controlled in [0x4020:003 \(P600.03\)](#).
9. If the output value of the process controller is to be limited, adapt the following parameters:
 - [0x4020:005 \(P600.05\)](#): Min speed limit
 - [0x4020:006 \(P600.06\)](#): Max speed limit
10. Test the following parameters with the default setting first and only adapt them if required:
 - [0x404B \(P604.00\)](#): Setpoint ramp
 - [0x404C:001 \(P607.01\)](#): acceleration time for showing the process controller influence
 - [0x404C:002 \(P607.02\)](#): deceleration time for hiding the process controller influence
11. Diagnostics: check the current reference value and feedback of the control variable:
 - The current reference value (setpoint) is displayed in [0x401F:001 \(P121.01\)](#).
 - The current variable (actual value) is displayed in [0x401F:002 \(P121.02\)](#).

After the basic setting of the process controller has been carried out, a fine adjustment of the PID controller must be executed for optimum control behaviour (see the following section).

Configuring the frequency control

Configuring the process controller
Basic setting



Fine adjustment of the PID controller

The dynamics of the PID controller are parameterised based on the gain of the P component [0x4048 \(P601.00\)](#), the reset time for the I component [0x4049 \(P602.00\)](#) and the gain of the D component [0x404A \(P603.00\)](#). In the default setting, the process controller operates as a PI controller. The D component is deactivated.

Basics

- If only the P component is used and the system operates in a steady-state status (the reference value is constant and the process variable is controlled to a fixed value), a certain system deviation always continues to exist. This remaining system deviation is also called "stationary deviation".
- The I component prevents a permanent fluctuation around the setpoint. Here, the reset time [0x4049 \(P602.00\)](#) determines how much the duration of the control deviation influences the control. A high reset time means a lower influence of the I component and vice versa.
- The D component does not respond to the height of the system deviation but to their rate of change only. The D component acts as a "damper" for overshoots. Overshoots may occur if the control tries to respond quickly to changes in the system deviation or the reference value. Thus, the D component reduces the risk of instabilities due to overshoots.



For most applications, the setting of the gain of the P component and the reset time for the I component is sufficient for the fine adjustment. The setting of the gain of the D component may be required for a further stabilisation of the system especially if a quick response to system deviations is to take place.

Execute fine adjustment:

1. Set the reset time for the I component to 6000 ms in [0x4049 \(P602.00\)](#) to deactivate the I component.
 - With this setting and the default setting of [0x404A \(P603.00\)](#), the process controller operates as P controller.
2. Increase gain of the P component step by step in [0x4048 \(P601.00\)](#) until the system becomes instable.
3. Reduce the gain again until the system is stable again.
4. Reduce the gain by another 15 %.
5. Set reset time for the I component in [0x4049 \(P602.00\)](#).
 - With this setting it should be noted that a too low reset time may cause overshoots, especially in case of high steps of the system deviation.
6. Optional: set the gain of the D component in [0x404A \(P603.00\)](#).
 - With this setting it should be noted that the D component responds very sensitively to electrical disturbance on the feedback as well as digitisation errors.



Configuring the frequency control

Configuring the process controller
Basic setting

Internal signal flow

The following illustration shows the internal signal flow of the process controller (without the additional functions "idle state" and "rinsing function"):

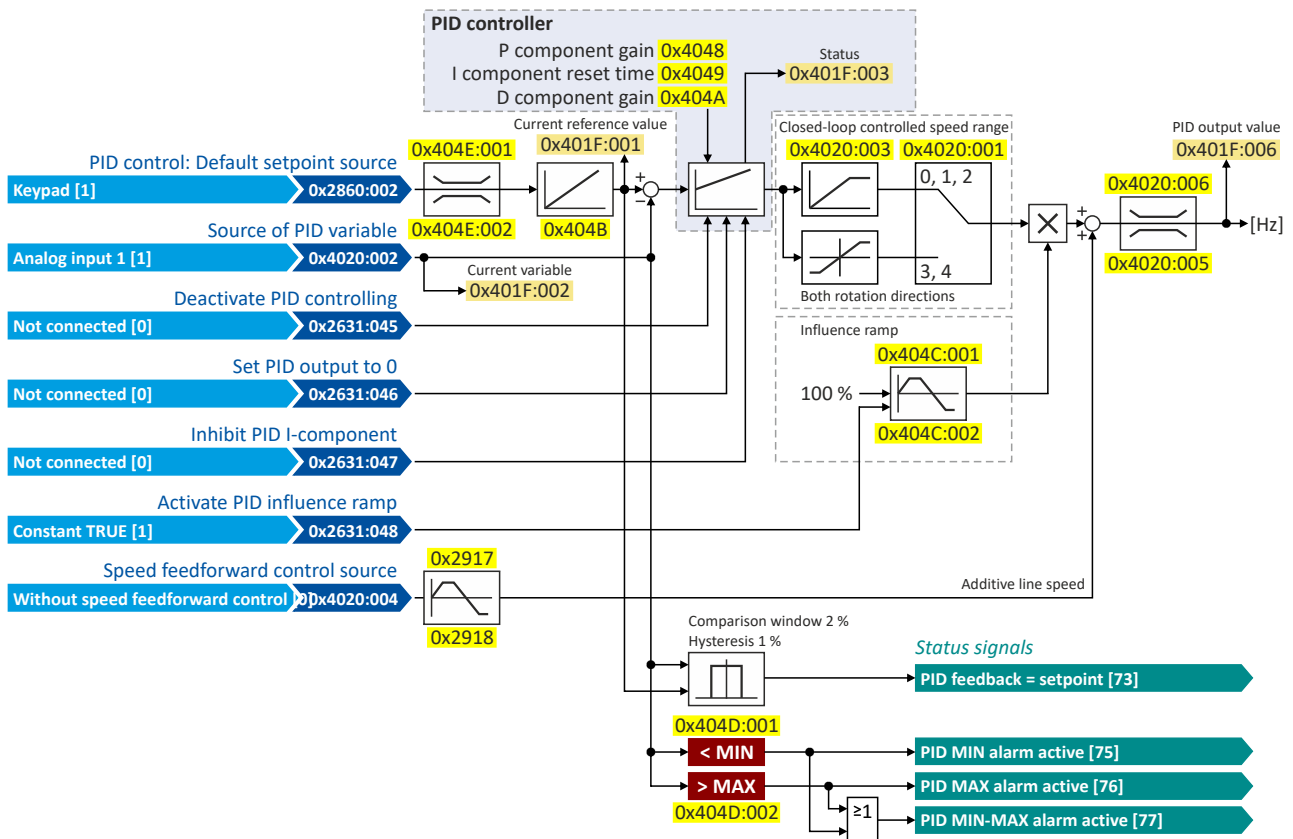

Control functions

The flexible I/O configuration serves to configure different control functions for the process controller:

- 0x2631:045 (P400.45): Deactivate PID controller
- 0x2631:046 (P400.46): Set process controller output to 0
- 0x2631:047 (P400.47): Inhibit process controller I-component
- 0x2631:048 (P400.48): Activate PID influence ramp

For details see chapter "Process controller function selection". [121](#)

Status signals for configurable outputs

The process controller provides different internal status signals. These status signals can be assigned to the relay, the digital outputs or the NetWordOUT1 status word.

For details see chapter "Configure digital outputs". [247](#)

Configuring the frequency control

Configuring the process controller Basic setting



Parameter

Address	Name / setting range / [default setting]	Information
0x2860:002 (P201.02)	PID control: Default setpoint source (PID setp. src.)	Selection of the standard setpoint source for the reference value of the PID control. <ul style="list-style-type: none"> The selected standard setpoint source is always active with an activated PID control when no setpoint change-over to another setpoint source via corresponding triggers/functions is active.
	1 Keypad	The setpoint is specified locally by the keypad. <ul style="list-style-type: none"> Default setting: 0x2601:002 (P202.02) Use the ↑ and ↓ navigation keys to change the keypad setpoint (also during running operation).
	2 Analog input 1	The setpoint is defined as analog signal via the analog input 1. ▶ Analog input 1 □ 240
	3 Analog input 2	The setpoint is defined as analog signal via the analog input 2. ▶ Analog input 2 □ 244
	5 Network	The setpoint is defined as process data object via the network. ▶ Define setpoint via network □ 273
	11 PID preset 1	For the setpoint selection, preset values can be parameterised and selected. ▶ Setpoint presets □ 83
	12 PID preset 2	
	13 PID preset 3	
	14 PID preset 4	
	15 PID preset 5	
	16 PID preset 6	
	17 PID preset 7	
	18 PID preset 8	
	31 Segment preset 1 (from version 03.00)	For the setpoint selection, the segment presets parameterised for the "sequencer" function can be selected as well. ▶ Sequencer □ 87
	32 Segment preset 2 (from version 03.00)	
	33 Segment preset 3 (from version 03.00)	
	34 Segment preset 4 (from version 03.00)	
	35 Segment preset 5 (from version 03.00)	
	36 Segment preset 6 (from version 03.00)	
	37 Segment preset 7 (from version 03.00)	
	38 Segment preset 8 (from version 03.00)	
	50 Motor potentiometer	The setpoint is generated by the "motor potentiometer" function. This function can be used as an alternative setpoint control which is controlled via two signals: "MOP setpoint up" and "MOP setpoint down". ▶ Motor potentiometer (MOP) □ 85
	201 Internal value (from version 05.00)	Internal values of the manufacturer.
202 Internal value (from version 05.00)		
203 Internal value (from version 05.00)		
204 Internal value (from version 05.00)		
205 Internal value (from version 05.00)		
206 Internal value (from version 05.00)		
0x4020:001 (P600.01)	Process controller setup (PID): Operating mode (PID setup: Operating mode)	Selection of the process controller operating mode.
	0 Inhibited	Process controller deactivated.
	1 Normal operation	The setpoint is higher than the feedback variable (actual value). If the system deviation increases, the motor speed is increased. Example: pressure-controlled booster pumps (increase in the motor speed produces an increase in pressure.)
	2 Reverse operation	The setpoint is lower than the feedback variable (actual value). If the system deviation increases, the motor speed is increased. Example: temperature-controlled cooling water pump (increase in motor speed produces decrease in temperature.)
	3 Normal bi-directional	The direction of rotation corresponds to the sign of the system deviation. If the system deviation increases, the motor speed is increased.
	4 Reverse bi-directional	A negative system deviation causes a positive direction of rotation. If the system deviation increases, the motor speed is increased.



Configuring the frequency control

Configuring the process controller Basic setting

Address	Name / setting range / [default setting]	Information
0x4020:002 (P600.02)	Process controller setup (PID): PID process variable (PID setup: PID process var.)	Selection of the source via which the feedback of the controlled variable (actual value) for the process controller is effected.
	1 Analog input 1	
	2 Analog input 2	
	3 DC-bus voltage (from version 02.00)	
	4 Motor Current (from version 02.00)	
	5 Network (from version 02.00)	
	6 HTL input (from version 04.00)	Selection is not supported by the inverter i510.
	201 Internal value	Internal values of the manufacturer.
	202 Internal value	
	203 Internal value	
204 Internal value		
205 Internal value		
206 Internal value		
0x4020:003 (P600.03)	Process controller setup (PID): Closed-loop controlled speed range (PID setup: PID speed range) 0 ... [100] ... 100 %	Setting of the maximum output frequency up to which the process controller carries out regulation. <ul style="list-style-type: none"> 100 % = Maximum frequency 0x2916 (P211.00).
0x4020:004 (P600.04)	Process controller setup (PID): Speed feedforward control source (PID setup: PID line speed)	Optional selection of a speed feedforward control source for the process controller. <ul style="list-style-type: none"> Is advisable, for instance, for dancer position controls if the motor speed must not fall below line speed (process controller output value = line speed + controlled motor speed). Standard applications usually do not require a speed feedforward control; therefore it is deactivated in the default setting.
	0 Without speed addition	
	1 Keypad frequency setpoint	
	2 Analog input 1	
	3 Analog input 2	
	4 Frequency preset 1	
	5 Frequency preset 2	
	6 Frequency preset 3	
	7 Frequency preset 4	
	8 Network	
	9 HTL input	
	201 Internal value	Internal values of the manufacturer.
	202 Internal value	
	203 Internal value	
204 Internal value		
205 Internal value		
206 Internal value		
0x4020:005 (P600.05)	Process controller setup (PID): Min speed limit (PID setup: Min speed lim) -100.0 ... [-100.0] ... 100.0 % <ul style="list-style-type: none"> From version 03.00 	Configuration of the process controller <ul style="list-style-type: none"> 100 % = Maximum frequency 0x2916 (P211.00). The limitation becomes effective after the line speed has been added. The value set here also limits the I component of the PID controller (Integrator-Anti-Windup).
0x4020:006 (P600.06)	Process controller setup (PID): Max speed limit (PID setup: Max speed lim) -100.0 ... [100.0] ... 100.0 % <ul style="list-style-type: none"> From version 03.00 	Maximum output value of the process controller. <ul style="list-style-type: none"> 100 % = Maximum frequency 0x2916 (P211.00). The limitation becomes effective after the line speed has been added. The value set here also limits the I component of the PID controller (Integrator-Anti-Windup).
0x4021:001 (P606.01)	PID speed operation: Acceleration time (PID speed op.: Accel. time) 0.0 ... [1.0] ... 3600.0 s	Acceleration time for (temporary) speed-controlled drive control in process controller mode. <ul style="list-style-type: none"> The acceleration time takes effect at the output of the process controller.
0x4021:002 (P606.02)	PID speed operation: Deceleration time (PID speed op.: Decel. time) 0.0 ... [1.0] ... 3600.0 s	Deceleration time for (temporary) speed-controlled drive control in process controller mode. <ul style="list-style-type: none"> The deceleration time takes effect at the output of the process controller. Exception: In case of quick stop, the quick stop delay time is effective.
0x4048 (P601.00)	PID P-component (PID P-component) 0.0 ... [5.0] ... 1000.0 %	Output frequency of the process controller per 1 % system deviation. <ul style="list-style-type: none"> 100 % = maximum frequency 0x2916 (P211.00).

Configuring the frequency control

Configuring the process controller Basic setting



Address	Name / setting range / [default setting]	Information
0x4049 (P602.00)	PID I- component (PID I- component) 10 ... [400] ... 6000 ms	Reset time for system deviation. <ul style="list-style-type: none"> With the setting "6000 ms", the I component is deactivated. The I component can also be deactivated via the "Inhibit process controller I-component" 0x2631:047 (P400.47) function.
0x404A (P603.00)	PID D-component (PID D-component) 0.0 ... [0.0] ... 20.0 s	D component, does not respond to the rate of the system deviation, but only to its rate of change.
0x404B (P604.00)	PID setpoint ramp (PID setp.ramp) 0.0 ... [20.0] ... 100.0 s	Acceleration time and deceleration time for the process controller setpoint, relating to 100 PID units Example: A setpoint increase from 0 PID units to 100 PID units with the default ramp takes 20s.
0x404C:001 (P607.01)	PID influence: Acceleration time for activation (PID influence: Activation time) 0.0 ... [5.0] ... 999.9 s	If the trigger assigned in 0x2631:048 (P400.48) of the "Activate PID influence ramp" function is TRUE, the influence of the process controller is shown by means of a ramp with the acceleration time set here.
0x404C:002 (P607.02)	PID influence: Deceleration time for masking out (PID influence: Mask out time) 0.0 ... [5.0] ... 999.9 s	If the trigger assigned in 0x2631:048 (P400.48) of the "Activate PID influence ramp" function is FALSE, the influence of the process controller is hidden via a ramp with the deceleration time set here.
0x404D:001 (P608.01)	PID alarms: MIN alarm threshold (PID alarms: MIN alarm thrsh.) -300.00 ... [0.00] ... 300.00 PID unit	Trigger threshold for the status signal "PID MIN alarm active [75]". <ul style="list-style-type: none"> The "PID MIN alarm active [75]" status signal is TRUE if the feedback variable (with activated PID control) is lower than the threshold set here. The status signal can be assigned to the relay or to a digital output. <ul style="list-style-type: none"> Configure digital outputs 247 The status signal can be assigned to the NetWordOUT1 status word. <ul style="list-style-type: none"> Define your own status word format 269
0x404D:002 (P608.02)	PID alarms: MAX alarm threshold (PID alarms: MAX alarm thrsh.) -300.00 ... [100.00] ... 300.00 PID unit	Trigger threshold for the status signal "PID MAX alarm active [76]". <ul style="list-style-type: none"> The "PID MAX alarm active [76]" status signal is TRUE if the feedback variable (with activated PID control) is higher than the threshold set here. The status signal can be assigned to the relay or to a digital output. <ul style="list-style-type: none"> Configure digital outputs 247 The status signal can be assigned to the NetWordOUT1 status word. <ul style="list-style-type: none"> Define your own status word format 269
0x404D:003 (P608.03)	PID alarms: Monitoring bandwidth PID feedback signal (PID alarms: Bandw. feedback) 0.00 ... [2.00] ... 100.00 % <ul style="list-style-type: none"> From version 04.00 	Hysteresis for status signal "PID feedback = setpoint [73]". <ul style="list-style-type: none"> 100 % = configured variable input range Example: Variable input range 0 ... 10 V: 2 % = 0.2 V The status signal "PID feedback = setpoint [73]" is TRUE if the controlled variable feedback = process controller setpoint (\pm hysteresis set here). The status signal can be assigned to the relay or to a digital output. <ul style="list-style-type: none"> Configure digital outputs 247 The status signal can be assigned to the NetWordOUT1 status word. <ul style="list-style-type: none"> Define your own status word format 269
0x404E:001 (P605.01)	PID setpoint limits: Minimum setpoint (PID setp. limit: Minimum setpoint) -300.00 ... [-300.00] ... 300.00 PID unit	Minimum value of the process controller setpoint.
0x404E:002 (P605.02)	PID setpoint limits: Maximum setpoint (PID setp. limit: Maximum setpoint) -300.00 ... [300.00] ... 300.00 PID unit	Maximum value of the process controller setpoint.

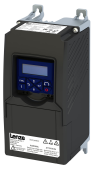

Configuring the frequency control

Configuring the process controller
Process controller sleep mode

7.3.2 Process controller sleep mode

If the PID control is activated, this function sets the drive in process controller mode to an energy-saving sleep mode when no power is required.

Details

A typical application for this function is a booster pump for water in a high-rise building. If no tenant opens the water tap or uses the shower for a longer period of time, the pump changes to the energy-saving sleep mode. This usually happens at night. The sleep mode automatically ends as soon as a tenant opens the tap again. The pumps operates normally again until the condition for the sleep mode is pending again.

The conditions for activating and terminating the sleep mode can be set independently of one another in [0x4023:001 \(P610.01\)](#) and [0x4023:006 \(P610.06\)](#) (see the following tables).

In [0x4023:005 \(P610.05\)](#), a delay time can be set for the activation. This is the minimum time the values must fall below or exceed the respective threshold before the sleep mode is activated.

0x4023:001 (P610.01)	Condition for activating the sleep mode			
0	Sleep mode deactivated.			
1	Frequency setpoint 0x2B0E (P102.00)	<	Frequency threshold 0x4023:003 (P610.03)	(+ 0x4023:005 (P610.05))
2	Frequency setpoint 0x2B0E (P102.00)	<	Frequency threshold 0x4023:003 (P610.03)	(+ 0x4023:005 (P610.05))
	OR			
3	Current process variable 0x401F:002 (P121.02)	>	Feedback threshold 0x4023:004 (P610.04)	(+ 0x4023:005 (P610.05))
	OR			
3	Frequency setpoint 0x2B0E (P102.00)	<	Frequency threshold 0x4023:003 (P610.03)	(+ 0x4023:005 (P610.05))
	OR			
3	Current process variable 0x401F:002 (P121.02)	<	Feedback threshold 0x4023:004 (P610.04)	(+ 0x4023:005 (P610.05))
	OR			
0x4023:006 (P610.06)	Condition for terminating the sleep mode			
0	Frequency setpoint 0x2B0E (P102.00)	>	Frequency threshold 0x4023:003 (P610.03)	(+ 2 Hz hysteresis)
	OR			
0	PID error value 0x401F:007	>	Bandwidth 0x4023:007 (P610.07)	
1	Current process variable 0x401F:002 (P121.02)	<	Recovery threshold 0x4023:008 (P610.08)	
2	Current process variable 0x401F:002 (P121.02)	>	Recovery threshold 0x4023:008 (P610.08)	

Configuring the frequency control

Configuring the process controller
Process controller sleep mode



Parameter

Address	Name / setting range / [default setting]	Information
0x4023:001 (P610.01)	PID sleep mode: Activation (PID sleep mode: Activation)	Condition for activating the sleep mode.
	0 Disabled	Sleep mode deactivated.
	1 Output frequency < threshold	0x2B0E (P102.00)<0x4023:003 (P610.03) (+ Delay time 0x4023:005 (P610.05))
	2 Output frequency < threshold OR process variable > feedback threshold	0x2B0E (P102.00)<0x4023:003 (P610.03) (+ Delay time 0x4023:005 (P610.05)) OR 0x401F:002 (P121.02)>0x4023:004 (P610.04) (+ Delay time 0x4023:005 (P610.05))
3 Output frequency < threshold OR process variable < feedback threshold	0x2B0E (P102.00)<0x4023:003 (P610.03) (+ Delay time 0x4023:005 (P610.05)) OR 0x401F:002 (P121.02)<0x4023:004 (P610.04) (+ Delay time 0x4023:005 (P610.05))	
0x4023:002 (P610.02)	PID sleep mode: Stop method (PID sleep mode: Stop method)	Selection of the stop method after activation of the sleep mode.
	0 Coasting	The motor has no torque (coasts down to standstill).
	1 Deceleration to standstill	The motor is brought to a standstill with deceleration time 1 (or deceleration time 2, if activated). • Deceleration time 1 can be set in 0x2918 (P221.00). • Deceleration time 2 can be set in 0x291A (P223.00). ▶ Ramp times <input type="checkbox"/> 80
2 Stop method set	The stop method set in 0x2838:003 (P203.03) is used.	
0x4023:003 (P610.03)	PID sleep mode: Frequency threshold (PID sleep mode: Freq. thresh.) 0.0 ... [0.0] ... 599.0 Hz	Frequency threshold for activating the sleep mode. • For comparing "output frequency < threshold" in case of selection 1 ... 3 in 0x4023:001 (P610.01).
0x4023:004 (P610.04)	PID sleep mode: Feedback threshold (PID sleep mode: Feedback thresh.) -300.00 ... [0.00] ... 300.00 PID unit	Feedback threshold for activating the sleep mode. • For comparing "variable > feedback threshold" in case of selection 2 in 0x4023:001 (P610.01). • For comparing "variable < feedback threshold" in case of selection 3 in 0x4023:001 (P610.01).
0x4023:005 (P610.05)	PID sleep mode: Delay time (PID sleep mode: Delay time) 0.0 ... [0.0] ... 300.0 s	Minimum time for which the respective threshold must be underrun or exceeded before the sleep mode is activated.
0x4023:006 (P610.06)	PID sleep mode: Recovery (PID sleep mode: Recovery)	Condition for terminating the sleep mode.
	0 Setpoint > threshold OR system deviation > bandwidth	0x2B0E (P102.00) > 0x4023:003 (P610.03) (+ 2 Hz hysteresis) OR 0x401F:007 > 0x4023:007 (P610.07)
	1 Process variable < recovery threshold	0x401F:002 (P121.02) < 0x4023:008 (P610.08)
2 Process variable > recovery threshold	0x401F:002 (P121.02) > 0x4023:008 (P610.08)	
0x4023:007 (P610.07)	PID sleep mode: Bandwidth (PID sleep mode: Bandwidth) 0.00 ... [0.00] ... 300.00 PID unit	Range around the process controller setpoint for ending the sleep mode. • 0.00 = bandwidth deactivated.
0x4023:008 (P610.08)	PID sleep mode: Recovery threshold (PID sleep mode: Recovery thresh.) -300.00 ... [0.00] ... 300.00 PID unit	Termination threshold for sleep mode.



Configuring the frequency control

Configuring the process controller
Process controller rinse function

7.3.3 Process controller rinse function

This function accelerates the motor in sleep mode of the process controller at regular intervals to a defined speed.

Details

A typical application for this function is the rinsing of a pipe system with a pump that has been in an inactive state for a longer period to prevent deposits.

- In order to activate the rinsing function, set the selection "Enabled [1]" in [0x4024:001 \(P615.01\)](#).
- The following diagram demonstrates the function:

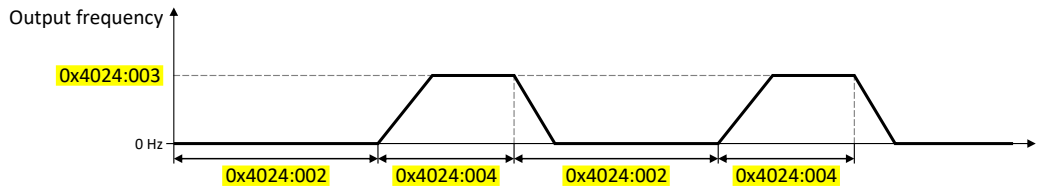

- The rinsing function uses the ramp times set for the "MS: Velocity mode". ▶ [Ramp times](#) 80

Parameter

Address	Name / setting range / [default setting]	Information
0x4024:001 (P615.01)	Automatic rinsing: Rinsing in sleep mode (Auto-rinsing: Rinsing in idle) 0 Inhibited 1 Enabled	1 = activate automatic rinsing in sleep mode.
0x4024:002 (P615.02)	Automatic rinsing: Rinse interval (Auto-rinsing: Rinse interval) 0.0 ... [30.0] ... 6000.0 min	Time interval between two rinsing processes.
0x4024:003 (P615.03)	Automatic rinsing: Rinse speed (Auto-rinsing: Rinse speed) -599.0 ... [0.0] ... 599.0 Hz	Speed setpoint for rinse function.
0x4024:004 (P615.04)	Automatic rinsing: Rinse period (Auto-rinsing: Rinse period) 0.0 ... [0.0] ... 6000.0 s	Duration of a rinsing process.

7.3.4 Process controller function selection

By means of the following functions, the response of the inverter can be controlled when PID control is activated.

Parameter

Address	Name / setting range / [default setting]	Information
0x2631:045 (P400.45)	Function list: Deactivate PID controller (Function list: PID off) • Further possible settings: ▶ Trigger list 59	Assignment of a trigger for the "Deactivate PID controller" function. Trigger = TRUE: If PID control is activated, ignore PID control and drive the motor in speed-controlled manner. Trigger = FALSE: If PID control is activated, drive the motor with PID control. Notes: • The PID control mode can be selected in 0x4020:001 (P600.01) .
	0 Not connected	No trigger assigned (trigger is constantly FALSE).
0x2631:046 (P400.46)	Function list: Set process controller output to 0 (Function list: PID output=0) • Further possible settings: ▶ Trigger list 59	Assignment of a trigger for the "Set process controller output to 0" function. Trigger = TRUE: If PID control is activated, I component and the output of the PID controller are set to 0 and the internal control algorithm is stopped. The PID control remains active. Trigger = FALSE: no action / deactivate function again.
	0 Not connected	No trigger assigned (trigger is constantly FALSE).

Configuring the frequency control

Configuring the process controller
Process controller function selection



Address	Name / setting range / [default setting]	Information
0x2631:047 (P400.47)	Function list: Inhibit process controller I-component (Function list: PID-I inhibited) • Further possible settings: ▶ Trigger list 59	Assignment of a trigger for the "Inhibit process controller I-component" function. Trigger = TRUE: If PID control is activated, the I component of the PID controller is set to 0 and the integration process is stopped. Trigger = FALSE: no action / deactivate function again. Notes: • The reset time can be set in 0x4049 (P602.00) .
	0 Not connected	No trigger assigned (trigger is constantly FALSE).
0x2631:048 (P400.48)	Function list: Activate PID influence ramp (Function list: PID-Inf ramp on) • Further possible settings: ▶ Trigger list 59	Assignment of a trigger for the "Activate PID influence ramp" function. Trigger = TRUE: the influence of the process controller is shown via a ramp. Trigger = FALSE or not connected: the influence of the process controller is hidden via ramp. Notes: • The influence of the process controller is always active (not only when PID control is activated). • Acceleration time for showing the influence of the process controller can be set in 0x404C:001 (P607.01) . • Deceleration time for hiding the influence of the process controller can be set in 0x404C:002 (P607.02) .
	1 Constant TRUE	Trigger is constantly TRUE.

Example for operating mode

In the following example, the "Deactivate PID controller" function is used to deactivate the PID control temporarily:

- As standard setpoint source, the frequency preset 1 is set to 20 Hz.
- The switch S1 starts the motor in forward rotating direction. The switch S1 in the initial position stops the motor again.
- The switch S2 deactivates the PID control. The motor is then driven in a speed-controlled way.

Connection plan	Function
	Switch S1 Run
	Switch S2 Deactivate PID controller

Parameter	Name	Setting for this example
0x2631:001 (P400.01)	Enable inverter	Constant TRUE [1]
0x2631:002 (P400.02)	Run	Digital input 1 [11]
0x2631:004 (P400.04)	Reset fault	Not connected [0]
0x2631:045 (P400.45)	Deactivate PID controller	Digital input 2 [12]
0x2824 (P200.00)	Control selection	Flexible I/O configuration [0]
0x2838:003 (P203.03)	Stop method	Standard ramp [1]
0x2860:001 (P201.01)	Frequency control: Default setpoint source	Frequency preset 1 [11]
0x2911:001 (P450.01)	Frequency setpoint presets: Preset 1	20 Hz
0x2916 (P211.00)	Maximum frequency	50 Hz



The example assumes that the process controller has been configured accordingly. ▶ [Basic setting](#) 113



Configuring the frequency control

Configuring the process controller
Process controller diagnostics

Input signals

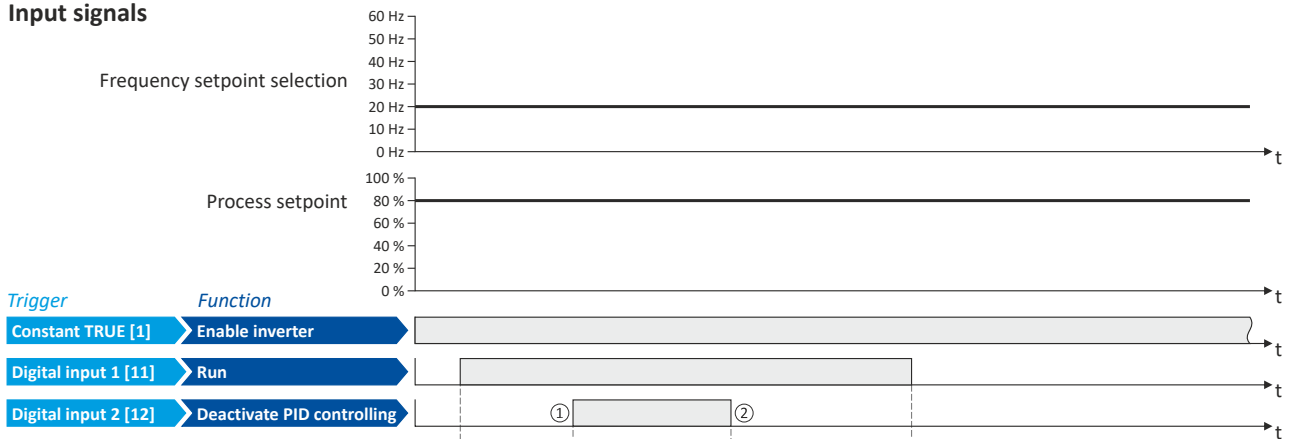

Output signals

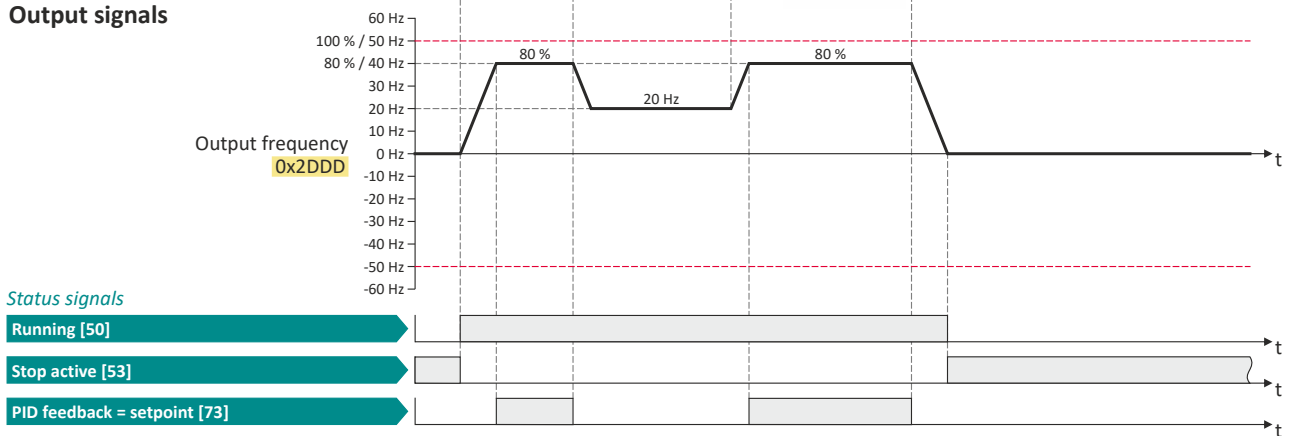

The status signals can be assigned to digital outputs. ▶ [Configure digital outputs](#) 247

- ① PID control is deactivated: a change-over is initiated from the configured PID control to speed-controlled operation.
- ② PID control is activated again: a change-over is initiated from speed-controlled operation back to the configured PID control.

7.3.5 Process controller diagnostics

The following parameters serve to diagnose the process controller.

Parameter

Address	Name / setting range / [default setting]	Information
0x401F:001 (P121.01)	Process controller diagnostics: Current setpoint (PID diagnostics: PID setpoint) • Read only: x.xx PID unit	Display of the current reference value (setpoint) for the process controller.
0x401F:002 (P121.02)	Process controller diagnostics: Current process variable (PID diagnostics: PID process var.) • Read only: x.xx PID unit	Display of the current controlled feedback variable (actual value) for the process controller.
0x401F:003 (P121.03)	Process controller diagnostics: Status (PID diagnostics: PID status) • Read only	Bit-coded status display of the process controller.
	Bit 0	Process controller off
	Bit 1	PID output set to 0
	Bit 2	PID I-component inhibited
	Bit 3	PID influence active
	Bit 4	Setpoint = actual value
	Bit 5	Sleep mode active
	Bit 6	Max. alarm
	Bit 7	Min. alarm

Configuring the frequency control

Configuring the process controller
Process controller diagnostics



Address	Name / setting range / [default setting]	Information
0x401F:004	Process controller diagnostics: PID control value <ul style="list-style-type: none">• Read only: x.x Hz• From version 03.00	Display of the output frequency after the PID controller, but without any influencing factor.
0x401F:005	Process controller diagnostics: PID Feedforward value <ul style="list-style-type: none">• Read only: x.x Hz• From version 03.00	Display of the feedforward control value for the process controller.
0x401F:006	Process controller diagnostics: PID output value <ul style="list-style-type: none">• Read only: x.x Hz• From version 03.00	Display of the current process controller setpoint that is internally transferred to the motor control (considering the feedforward control value).
0x401F:007	Process controller diagnostics: PID error value <ul style="list-style-type: none">• Read only: x.xx PID unit• From version 03.00	Display of the difference between reference value (setpoint) and feedback variable (actual value) of the process controller.



7.4 Changing the setpoint source during operation

The inverter receives its setpoint from the selected standard setpoint source. For applications requiring a change-over of the setpoint source during operation, the functions listed below must be configured.

Details

For further details and examples, see the following subchapters.



In case of an activated network control, the functions for setpoint change-over are not active! If in case of network control no setpoint is defined via the network control word, the standard setpoint source is active.

Function	Info
Activate AI1 setpoint 0x2631:014 (P400.14)	Activate analog input 1 as setpoint source. ▶ Analog input 1 □ 240 ▶ Example: Change-over from keypad setpoint to AI1/AI2 setpoint □ 129
Activate AI2 setpoint 0x2631:015 (P400.15)	Activate analog input 2 as setpoint source. ▶ Analog input 2 □ 244 ▶ Example: Change-over from keypad setpoint to AI1/AI2 setpoint □ 129
Activate keypad setpoint 0x2631:016 (P400.16)	Activate keypad as setpoint source. • The keypad setpoint can be changed in the operating mode via the navigation keys ↑ and ↓ . ▶ Keypad □ 82 ▶ Example: Change-over from AI1 setpoint to keypad setpoint □ 131
Activate network setpoint 0x2631:017 (P400.17)	Activate network as setpoint source. ▶ Define setpoint via network □ 273
Activate preset (bit 0) 0x2631:018 (P400.18)	Activate parameterizable setpoints (presets) as setpoint source. • 15 frequency setpoints and 8 PID setpoints can be set as presets. • A preset can be selected binary-coded via the four functions "Activate preset (bit 0)" ... "Activate preset (bit 3)". ▶ Setpoint presets □ 83 ▶ Example: Change-over from keypad setpoint to preset 1 ... 7 □ 133
Activate preset (bit 1) 0x2631:019 (P400.19)	
Activate preset (bit 2) 0x2631:020 (P400.20)	
Activate preset (bit 3) 0x2631:021 (P400.21)	
Activate MOP setpoint 0x2631:025 (P400.25)	The "Motor potentiometer" function can be used as an alternative setpoint control that is controlled via two functions: "MOP setpoint up" and "MOP setpoint down". ▶ Motor potentiometer (MOP) □ 85 ▶ Example: Change-over from AI1 setpoint to MOP setpoint □ 136
Activate segment setpoint (bit 0) 0x2631:026 (P400.26)	Activate parameterizable segment setpoints as setpoint source. • The four functions "Activate segment setpoint (bit 0)" ... "Activate segment setpoint (bit 3)" enable a setpoint change-over to a segment setpoint parameterized for the "sequencer" function during normal operation. ▶ Segment configuration □ 89
Activate segment setpoint (bit 1) 0x2631:027 (P400.27)	
Activate segment setpoint (bit 2) 0x2631:028 (P400.28)	
Activate segment setpoint (bit 3) 0x2631:029 (P400.29)	

Diagnostic parameters:

- 0x282B:002 (P125.02): Active setpoint source

Configuring the frequency control

Changing the setpoint source during operation



Priority of the setpoint sources

Since only one setpoint source can be active at a time, the following priorities apply:

Flexible I/O configuration or keypad control active 0x2631:037 (P400.37) = FALSE	Network control active 0x2631:017 (P400.17) = FALSE 0x2631:037 (P400.37) = TRUE
<p>Prio 1: Functions for setpoint change-over</p> <p>The priority of the functions results from the assigned triggers (in the order of the selection list):</p> <ol style="list-style-type: none"> 1. Constant TRUE [1] 2. Digital input 1 [11] 3. Digital input 2 [12] 4. Digital input 3 [13] 5. ... <p>Prio 2: Set standard setpoint source</p> <ul style="list-style-type: none"> • 0x2860:001 (P201.01): Frequency control: Default setpoint source • 0x2860:002 (P201.02): PID control: Default setpoint source 	<p>Prio 1: Setpoint source selected via network control word</p> <p>▶ Control the inverter via network □ 258</p> <p>Prio 2: Set standard setpoint source</p> <ul style="list-style-type: none"> • 0x2860:001 (P201.01): Frequency control: Default setpoint source • 0x2860:002 (P201.02): PID control: Default setpoint source

Example of allocating priority

Parameter	Designation	Setting for this example
0x2631:014 (P400.14)	Activate AI1 setpoint	Digital input 5 [15]
0x2631:016 (P400.16)	Activate keypad setpoint	Digital input 4 [14]

Digital input 4	Digital input 5	Active setpoint source
FALSE	FALSE	Standard setpoint source set in 0x2860:001 (P201.01)
FALSE	TRUE	Analog input 1
TRUE	FALSE	Keypad
TRUE	TRUE	Keypad (since "Digital input 4" trigger is higher in the selection list than "Digital input 5" trigger)

Parameter

Address	Name / setting range / [default setting]	Information
0x2631:014 (P400.14)	Function list: Activate AI1 setpoint (Function list: Setp: AI1) • Further possible settings: ▶ Trigger list □ 59	Assignment of a trigger for the "Activate AI1 setpoint" function. Trigger = TRUE: analog input 1 is used as setpoint source (if the trigger assigned has the highest setpoint priority). Trigger = FALSE: no action / deactivate function again.
	0 Not connected	No trigger assigned (trigger is constantly FALSE).
0x2631:015 (P400.15)	Function list: Activate AI2 setpoint (Function list: Setp: AI2) • Further possible settings: ▶ Trigger list □ 59	Assignment of a trigger for the "Activate AI2 setpoint" function. Trigger = TRUE: analog input 2 is used as setpoint source (if the trigger assigned has the highest setpoint priority). Trigger = FALSE: no action / deactivate function again.
	0 Not connected	No trigger assigned (trigger is constantly FALSE).
0x2631:016 (P400.16)	Function list: Activate keypad setpoint (Function list: Setp: Keypad) • Further possible settings: ▶ Trigger list □ 59	Assignment of a trigger for the "Activate keypad setpoint" function. Trigger = TRUE: the keypad is used as setpoint source (if the trigger assigned has the highest setpoint priority). Trigger = FALSE: no action / deactivate function again. Notes: • The default keypad setpoint can be changed in keypad operating mode via the arrow keys of the keypad.
	0 Not connected	No trigger assigned (trigger is constantly FALSE).
0x2631:017 (P400.17)	Function list: Activate network setpoint (Function list: Setp: Network) • From version 02.01 • Further possible settings: ▶ Trigger list □ 59	Assignment of a trigger for the "Activate network setpoint" function. Trigger = TRUE: the network is used as setpoint source (if the trigger assigned has the highest setpoint priority). Trigger = FALSE: no action / deactivate function again.
	0 Not connected	No trigger assigned (trigger is constantly FALSE).
	116 Network setpoint active (from version 02.00)	TRUE if a change-over to network setpoint is requested via bit 6 of the AC drive control word 0x400B:001 (P592.01). Otherwise FALSE. Notes: • This setting is used if bit 6 of the AC drive control word is to be used independently of bit 5 AC drive control word. • The AC drive control word can be used with any communication protocol. ▶ AC drive control word □ 305



Configuring the frequency control

Changing the setpoint source during operation

Address	Name / setting range / [default setting]	Information
0x2631:018 (P400.18)	Function list: Activate preset (bit 0) (Function list: Setp: Preset b0) • Further possible settings: ▶ Trigger list 59	Assignment of a trigger for the "Activate preset (bit 0)" function. The bit with the valency 2^0 for bit-coded selection and the activation of a parameterised setpoint (preset). Trigger = FALSE: bit = "0". Trigger = TRUE: bit = "1".
	14 Digital input 4	State of X3/DI4, taking an inversion set in 0x2632:004 (P411.04) into consideration.
0x2631:019 (P400.19)	Function list: Activate preset (bit 1) (Function list: Setp: Preset b1) • Further possible settings: ▶ Trigger list 59	Assignment of a trigger for the "Activate preset (bit 1)" function. The bit with the valency 2^1 for bit-coded selection and the activation of a parameterised setpoint (preset). Trigger = FALSE: bit = "0". Trigger = TRUE: bit = "1".
	15 Digital input 5	State of X3/DI5, taking an inversion set in 0x2632:005 (P411.05) into consideration.
0x2631:020 (P400.20)	Function list: Activate preset (bit 2) (Function list: Setp: Preset b2) • Further possible settings: ▶ Trigger list 59	Assignment of a trigger for the "Activate preset (bit 2)" function. The bit with the valency 2^2 for bit-coded selection and the activation of a parameterised setpoint (preset). Trigger = FALSE: bit = "0". Trigger = TRUE: bit = "1".
	0 Not connected	No trigger assigned (trigger is constantly FALSE).
0x2631:021 (P400.21)	Function list: Activate preset (bit 3) (Function list: Setp: Preset b3) • Further possible settings: ▶ Trigger list 59	Assignment of a trigger for the "Activate preset (bit 3)" function. Selection bit with the valency 2^3 for the bit-coded selection and activation of a parameterised setpoint (preset value). Trigger = FALSE: selection bit = "0". Trigger = TRUE: selection bit = "1".
	0 Not connected	No trigger assigned (trigger is constantly FALSE).
0x2631:025 (P400.25)	Function list: Activate MOP setpoint (Function list: Setp: MOP) • Further possible settings: ▶ Trigger list 59	Assignment of a trigger for the "Activate MOP setpoint" function. Trigger = TRUE: the "Motor potentiometer" function is used as setpoint source (if the trigger assigned has the highest setpoint priority). Trigger = FALSE: no action / deactivate function again.
	0 Not connected	No trigger assigned (trigger is constantly FALSE).
0x2631:026 (P400.26)	Function list: Activate segment setpoint (bit 0) (Function list: Setp: Segment b0) • From version 03.00 • Further possible settings: ▶ Trigger list 59	Assignment of a trigger for the "Activate segment setpoint (bit 0)" function. Selection bit with the valency 20 for the bit-coded selection and activation of a parameterised segment setpoint. Trigger = FALSE: selection bit = "0". Trigger = TRUE: selection bit = "1". Notes: • During normal operation (no active sequence), this function serves to activate the setpoint of a segment (instead of an entire sequence in the sequencer operation). • This function is not intended for the use in the sequencer operation.
	0 Not connected	No trigger assigned (trigger is constantly FALSE).
0x2631:027 (P400.27)	Function list: Activate segment setpoint (bit 1) (Function list: Setp: Segment b1) • From version 03.00 • Further possible settings: ▶ Trigger list 59	Assignment of a trigger for the "Activate segment setpoint (bit 1)" function. Selection bit with the valency 2^1 for the bit-coded selection and activation of a parameterised segment setpoint. Trigger = FALSE: selection bit = "0". Trigger = TRUE: selection bit = "1". Notes: • During normal operation (no active sequence), this function serves to activate the setpoint of a segment (instead of an entire sequence in the sequencer operation). • This function is not intended for the use in the sequencer operation.
	0 Not connected	No trigger assigned (trigger is constantly FALSE).

Configuring the frequency control

Changing the setpoint source during operation



Address	Name / setting range / [default setting]	Information
0x2631:028 (P400.28)	Function list: Activate segment setpoint (bit 2) (Function list: Setp: Segment b2) <ul style="list-style-type: none"> From version 03.00 Further possible settings: ▶ Trigger list □ 59 	Assignment of a trigger for the "Activate segment setpoint (bit 2)" function. Selection bit with the valency 2^2 for the bit coded selection and activation of a parameterised segment setpoint. Trigger = FALSE: selection bit = "0". Trigger = TRUE: selection bit = "1". Notes: <ul style="list-style-type: none"> During normal operation (no active sequence), this function serves to activate the setpoint of a segment (instead of an entire sequence in the sequencer operation). This function is not intended for the use in the sequencer operation.
	0 Not connected	No trigger assigned (trigger is constantly FALSE).
0x2631:029 (P400.29)	Function list: Activate segment setpoint' (bit 3) (Function list: Setp: Segment b3) <ul style="list-style-type: none"> From version 03.00 Further possible settings: ▶ Trigger list □ 59 	Assignment of a trigger for the "Activate segment setpoint' (bit 3)" function. Selection bit with the valency 2^3 for the bit coded selection and activation of a parameterised segment setpoint. Trigger = FALSE: selection bit = "0". Trigger = TRUE: selection bit = "1". Notes: <ul style="list-style-type: none"> During normal operation (no active sequence), this function serves to activate the setpoint of a segment (instead of an entire sequence in the sequencer operation). This function is not intended for the use in the sequencer operation.
	0 Not connected	No trigger assigned (trigger is constantly FALSE).



Configuring the frequency control

Changing the setpoint source during operation
 Example: Change-over from keypad setpoint to AI1/AI2 setpoint

7.4.1 Example: Change-over from keypad setpoint to AI1/AI2 setpoint

- The keypad is set as standard setpoint source.
- The switch S1 starts the motor in forward rotating direction. The switch S1 in the initial position stops the motor again.
- The switch S2 switches the direction of rotation.
- The switch S3 activates analog input 1 as setpoint source.
- The switch S4 activates analog input 2 as setpoint source.



If S3 and S4 are actuated at the same time, the analogue input 1 is active as setpoint source since the digital input 3 assigned to this function has a higher priority than the digital input 4.

Connection plan	Function	
	Potentiometer R1	Frequency setpoint selection via AI1
	Potentiometer R2	Frequency setpoint selection via AI2
	Switch S1	Run
	Switch S2	Reverse rotational direction
	Switch S3	Activate AI1 setpoint
	Switch S4	Activate AI2 setpoint

Parameter	Name	Setting for this example
0x2631:001 (P400.01)	Enable inverter	Constant TRUE [1]
0x2631:002 (P400.02)	Run	Digital input 1 [11]
0x2631:004 (P400.04)	Reset fault	Not connected [0]
0x2631:013 (P400.13)	Reverse rotational direction	Digital input 2 [12]
0x2631:014 (P400.14)	Activate AI1 setpoint	Digital input 3 [13]
0x2631:015 (P400.15)	Activate AI2 setpoint	Digital input 4 [14]
0x2631:018 (P400.18)	Activate preset (bit 0)	Not connected [0]
0x2824 (P200.00)	Control selection	Flexible I/O configuration [0]
0x2838:003 (P203.03)	Stop method	Standard ramp [1]
0x2860:001 (P201.01)	Frequency control: Default setpoint source	Keypad [1]

Configuring the frequency control

Changing the setpoint source during operation

Example: Change-over from keypad setpoint to AI1/AI2 setpoint



Input signals

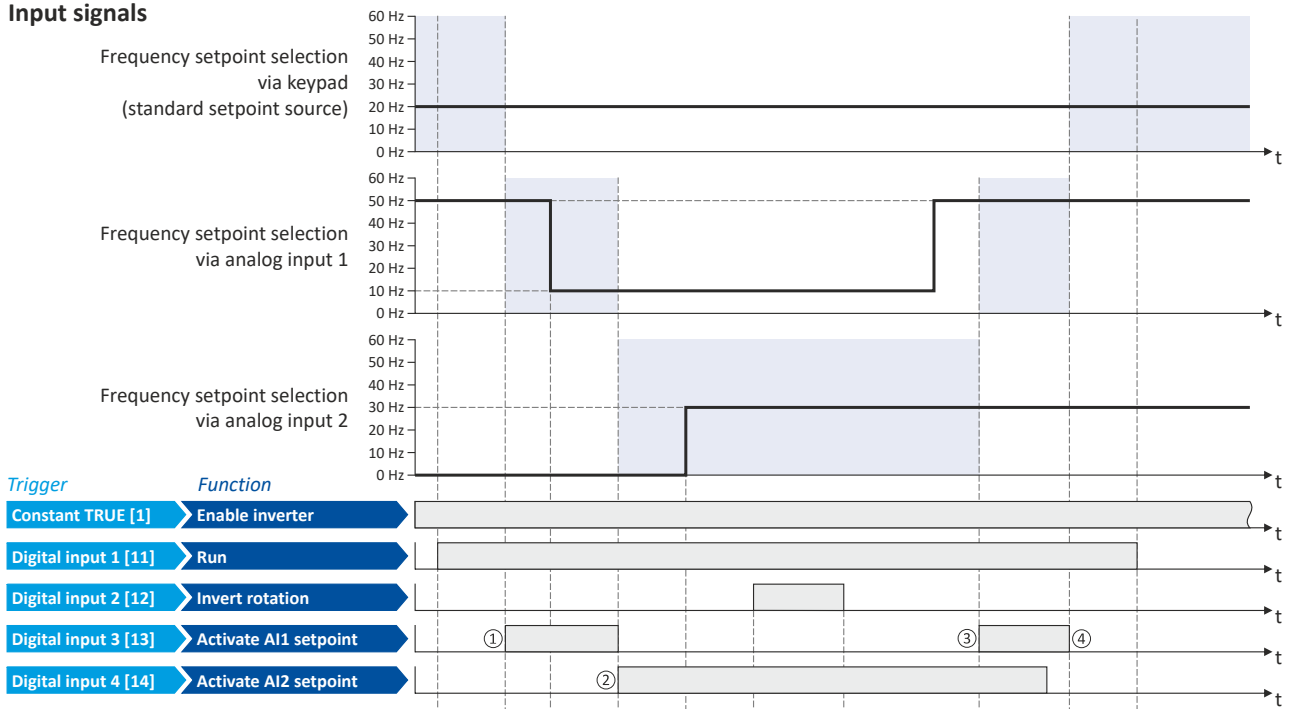

Output signals

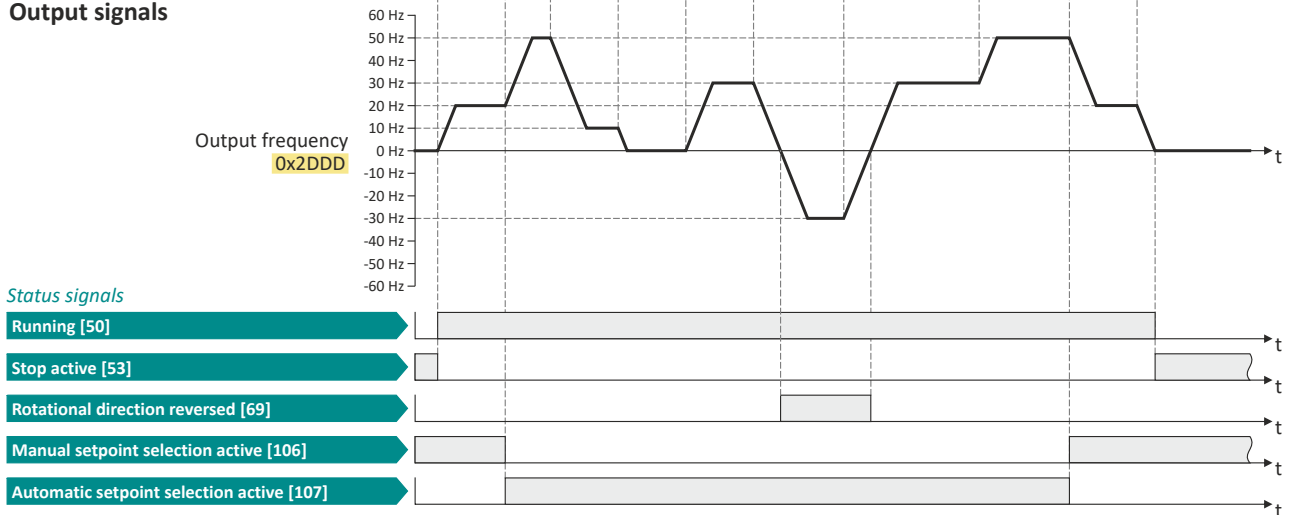

The status signals can be assigned to digital outputs. [▶ Configure digital outputs](#) 247

- ① The change-over is initiated from keypad setpoint (standard setpoint source) to AI1 setpoint.
- ② The change-over is initiated from AI1 setpoint to AI2 setpoint.
- ③ The change-over is initiated from AI2 setpoint to AI1 setpoint since the digital input 3 has a higher priority than the digital input 4.
- ④ The change-over is initiated to keypad setpoint (standard setpoint source).



Configuring the frequency control

Changing the setpoint source during operation
 Example: Change-over from AI1 setpoint to keypad setpoint

7.4.2 Example: Change-over from AI1 setpoint to keypad setpoint

- The analog input 1 is set as standard setpoint source.
- Switch S1 starts the motor in forward direction of rotation. Switch S1 in initial position stops the motor again.
- Switch S2 switches the direction of rotation.
- Switch S3 activates the keypad as setpoint source. The keypad setpoint can be changed in the operating mode via the navigation keys ↑ and ↓.

Connection plan	Function	
	Potentiometer R1	Frequency setpoint selection
	Switch S1	Run
	Switch S2	Reverse rotational direction
	Switch S3	Activate keypad setpoint

Parameter	Name	Setting for this example
0x2601:001 (P202.01)	Keypad setpoints: Frequency setpoint	20.0 Hz
0x2631:001 (P400.01)	Enable inverter	Constant TRUE [1]
0x2631:002 (P400.02)	Run	Digital input 1 [11]
0x2631:004 (P400.04)	Reset fault	Not connected [0]
0x2631:013 (P400.13)	Reverse rotational direction	Digital input 2 [12]
0x2631:016 (P400.16)	Activate keypad setpoint	Digital input 3 [13]
0x2824 (P200.00)	Control selection	Flexible I/O configuration [0]
0x2838:003 (P203.03)	Stop method	Standard ramp [1]
0x2860:001 (P201.01)	Frequency control: Default setpoint source	Analog input 1 [2]

Configuring the frequency control

Changing the setpoint source during operation

Example: Change-over from AI1 setpoint to keypad setpoint

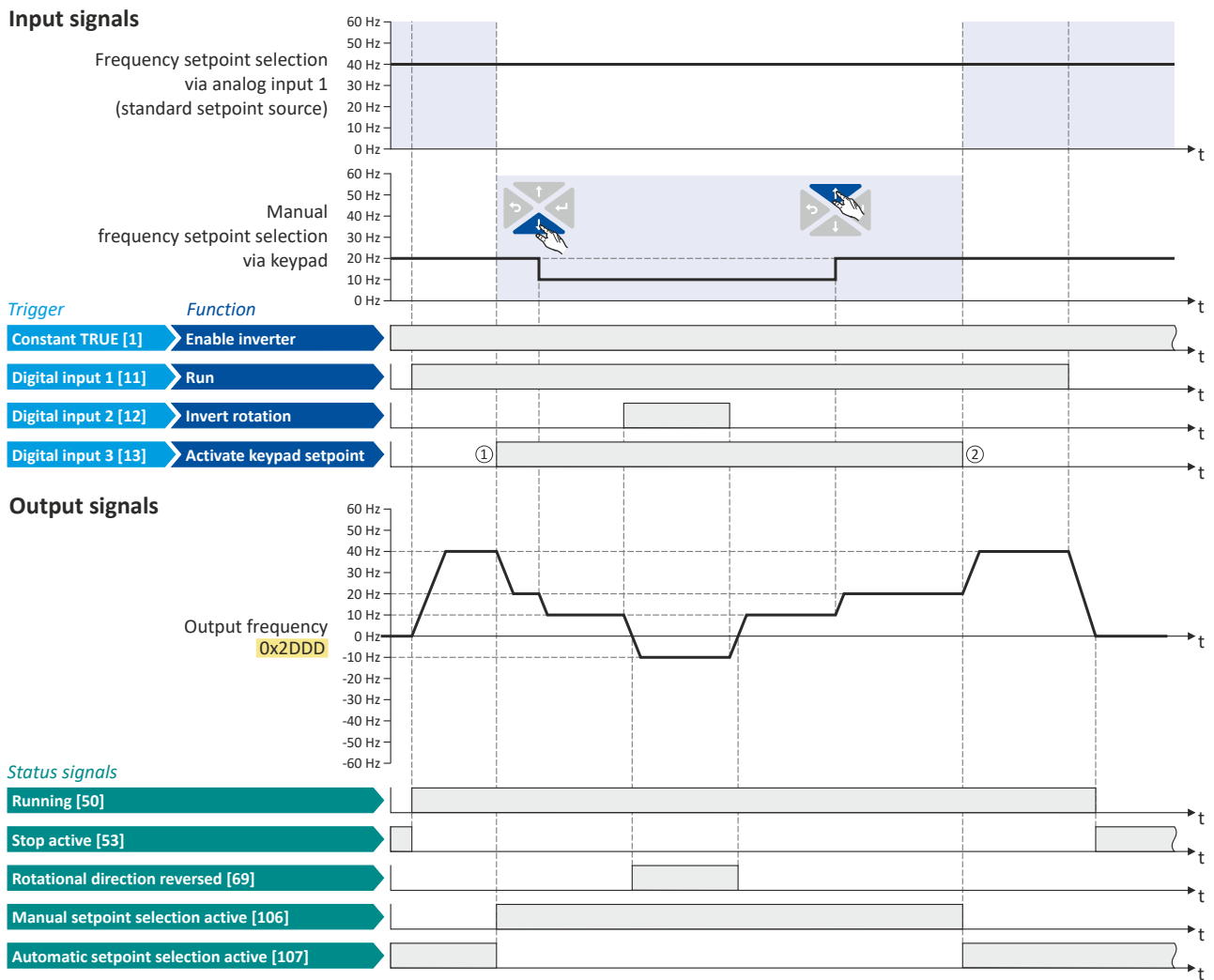

The status signals can be assigned to digital outputs. ▶ [Configure digital outputs](#) 247

- Change-over from analog input 1 (standard setpoint source) to keypad setpoint.
- Change-over from keypad setpoint back to analog input 1 (standard setpoint source).



Configuring the frequency control

Changing the setpoint source during operation
 Example: Change-over from keypad setpoint to preset 1 ... 7

7.4.3 Example: Change-over from keypad setpoint to preset 1 ... 7

The four functions "Activate preset (bit 0)" ... "Activate preset (bit 3)" enable change-over of the setpoint to a parameterisable setpoint (preset value).

Details

A preset is selected in a binary-coded fashion via the triggers assigned to the four functions "Activate preset (Bit 0)" ... "Activate preset (Bit 3)" in compliance with the following truth table:

Activate preset				Selection			
Bit 3 0x2631:021 (P400.21)	Bit 2 0x2631:020 (P400.20)	Bit 1 0x2631:019 (P400.19)	Bit 0 0x2631:018 (P400.18)	Preset	Frequency setpoint	PID setpoint	Torque setpoint
FALSE	FALSE	FALSE	FALSE	No preset selected			
FALSE	FALSE	FALSE	TRUE	Preset 1	0x2911:001 (P450.01)	0x4022:001 (P451.01)	0x2912:001 (P452.01)
FALSE	FALSE	TRUE	FALSE	Preset 2	0x2911:002 (P450.02)	0x4022:002 (P451.02)	0x2912:002 (P452.02)
FALSE	FALSE	TRUE	TRUE	Preset 3	0x2911:003 (P450.03)	0x4022:003 (P451.03)	0x2912:003 (P452.03)
FALSE	TRUE	FALSE	FALSE	Preset 4	0x2911:004 (P450.04)	0x4022:004 (P451.04)	0x2912:004 (P452.04)
FALSE	TRUE	FALSE	TRUE	Preset 5	0x2911:005 (P450.05)	0x4022:005 (P451.05)	0x2912:005 (P452.05)
FALSE	TRUE	TRUE	FALSE	Preset 6	0x2911:006 (P450.06)	0x4022:006 (P451.06)	0x2912:006 (P452.06)
FALSE	TRUE	TRUE	TRUE	Preset 7	0x2911:007 (P450.07)	0x4022:007 (P451.07)	0x2912:007 (P452.07)
TRUE	FALSE	FALSE	FALSE	Preset 8	0x2911:008 (P450.08)	0x4022:008 (P451.08)	0x2912:008 (P452.08)
TRUE	FALSE	FALSE	TRUE	Preset 9	0x2911:009 (P450.09)		
...					
TRUE	TRUE	TRUE	TRUE	Preset 15	0x2911:015 (P450.15)		

Configuring the frequency control

Changing the setpoint source during operation

Example: Change-over from keypad setpoint to preset 1 ... 7



Example for operating mode

- The keypad is set as standard setpoint source.
- Switch S1 starts the motor in forward direction of rotation. Switch S1 in initial position stops the motor again.
- The switches S2 ... S4 serve to switch over to the presets 1 ... 7 (see the following table).

Connection plan	Function				
	Switch S1	Run			
	Switches S2 ... S4	Preset selection:			
		S2	S3	S4	
		Off	Off	Off	Keypad setpoint
		On	Off	Off	Preset value 1
		Off	On	Off	Preset value 2
		On	On	Off	Preset value 3
		Off	Off	On	Preset value 4
		On	Off	On	Preset value 5
Off	On	On	Preset value 6		
On	On	On	Preset value 7		

Parameter	Name	Setting for this example
0x2631:001 (P400.01)	Enable inverter	Constant TRUE [1]
0x2631:002 (P400.02)	Run	Digital input 1 [11]
0x2631:004 (P400.04)	Reset fault	Not connected [0]
0x2631:013 (P400.13)	Reverse rotational direction	Not connected [0]
0x2631:018 (P400.18)	Activate preset (bit 0)	Digital input 2 [12]
0x2631:019 (P400.19)	Activate preset (bit 1)	Digital input 3 [13]
0x2631:020 (P400.20)	Activate preset (bit 2)	Digital input 4 [14]
0x2824 (P200.00)	Control selection	Flexible I/O configuration [0]
0x2838:003 (P203.03)	Stop method	Standard ramp [1]
0x2860:001 (P201.01)	Frequency control: Default setpoint source	Keypad [1]
0x2911:001 (P450.01)	Frequency setpoint presets: Preset 1	10 Hz
0x2911:002 (P450.02)	Frequency setpoint presets: Preset 2	15 Hz
0x2911:003 (P450.03)	Frequency setpoint presets: Preset 3	20 Hz
0x2911:004 (P450.04)	Frequency setpoint presets: Preset 4	25 Hz
0x2911:005 (P450.05)	Frequency setpoint presets: Preset 5	30 Hz
0x2911:006 (P450.06)	Frequency setpoint presets: Preset 6	35 Hz
0x2911:007 (P450.07)	Frequency setpoint presets: Preset 7	40 Hz



If the frequency presets 8 ... 15 are required as well, the digital input 5 must be additionally assigned to the "Activate preset (bit 3)" function and the terminal DI5 must be interconnected accordingly.



Configuring the frequency control

Changing the setpoint source during operation

Example: Change-over from keypad setpoint to preset 1 ... 7

Input signals

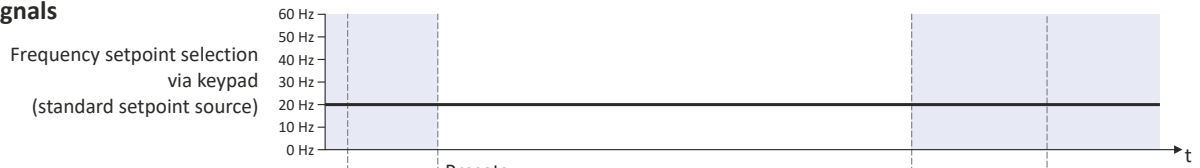

Presets						
0x2911:1	0x2911:2	0x2911:3	0x2911:4	0x2911:5	0x2911:6	0x2911:7
10 Hz	15 Hz	20 Hz	25 Hz	30 Hz	35 Hz	40 Hz

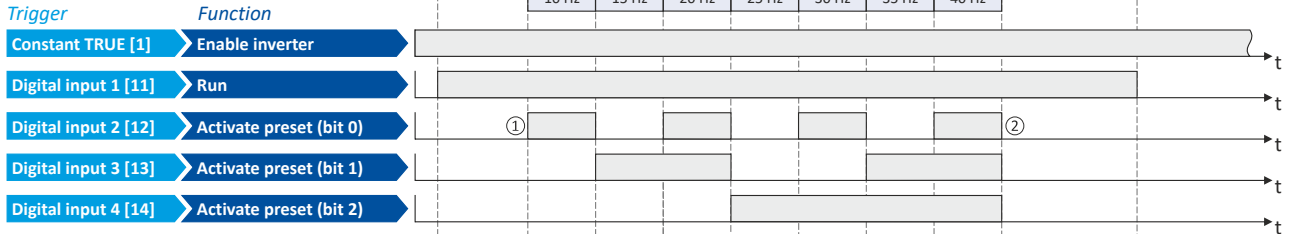

Output signals

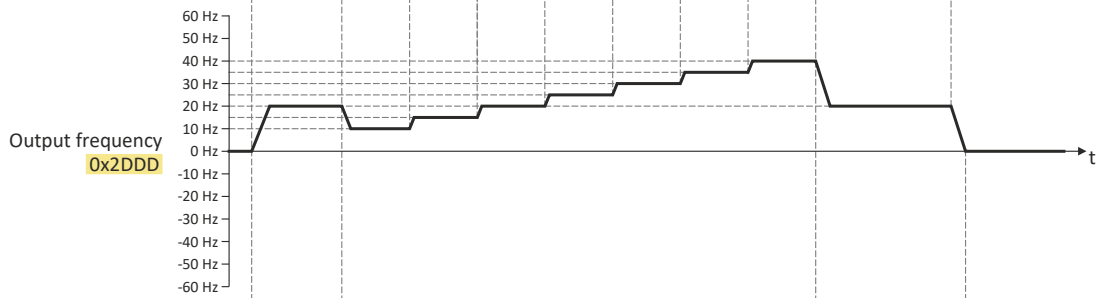

Status signals

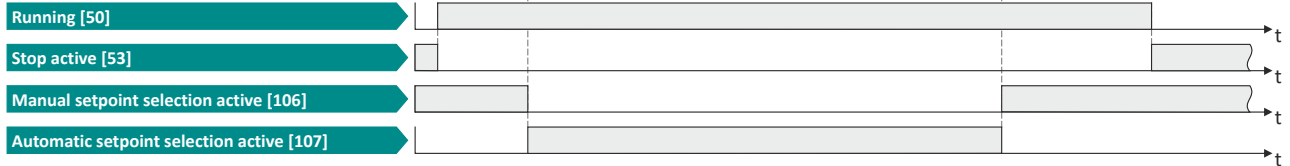

The status signals can be assigned to digital outputs. ▶ [Configure digital outputs](#) 247

- Change-over from keypad setpoint (standard setpoint source) to presets (first, preset 1 is selected).
- Change-over back to keypad setpoint since no preset is selected anymore (digital inputs 2 ... 4 = FALSE).

Configuring the frequency control

Changing the setpoint source during operation

Example: Change-over from AI1 setpoint to MOP setpoint



7.4.4 Example: Change-over from AI1 setpoint to MOP setpoint

The "Activate MOP setpoint" function enables a setpoint change-over to the motor potentiometer during operation.

Preconditions

A setpoint change-over to the motor potentiometer is only effected if

- no setpoint source with a higher priority has been selected. ▶ [Priority of the setpoint sources](#) 126
- no jog operation is active ("Jog forward (CW)" and "Jog reverse (CCW)" functions).

Example for operating mode

- The analog input 1 is set as standard setpoint source.
- Switch S1 starts the motor in forward direction of rotation. Switch S1 in initial position stops the motor again.
- Switch S2 activates the motor potentiometer as setpoint source. The MOP setpoint can then be increased via button S3 and reduced via button S4. If both buttons are pressed at the same time, the MOP setpoint remains unchanged.
- Switch S5 switches the direction of rotation.

Connection plan	Function
	Potentiometer R1
	Frequency setpoint selection
	Switch S1
	Run
	Switch S2
	Activate MOP setpoint
Button S3	
MOP setpoint up	
Button S4	
MOP setpoint down	
Switch S5	
Reverse rotational direction	

Parameter	Name	Setting for this example
0x2631:001 (P400.01)	Enable inverter	Constant TRUE [1]
0x2631:002 (P400.02)	Run	Digital input 1 [11]
0x2631:025 (P400.25)	Activate MOP setpoint	Digital input 2 [12]
0x2631:023 (P400.23)	MOP setpoint up	Digital input 3 [13]
0x2631:024 (P400.24)	MOP setpoint down	Digital input 4 [14]
0x2631:013 (P400.13)	Reverse rotational direction	Digital input 5 [15]
0x2824 (P200.00)	Control selection	Flexible I/O configuration [0]
0x2838:003 (P203.03)	Stop method	Standard ramp [1]
0x2860:001 (P201.01)	Frequency control: Default setpoint source	Analog input 1 [2]
0x2917 (P220.00)	Acceleration time 1	1.0 s
0x2918 (P221.00)	Deceleration time 1	1.0 s
0x2919 (P222.00)	Acceleration time 2	4.0 s (for MOP setpoint change)
0x291A (P223.00)	Deceleration time 2	4.0 s (for MOP setpoint change)
0x4003 (P413.00)	MOP starting mode	Starting value [1]
0x4004:001 (P414.01)	MOP starting values: Frequency	20 Hz



Configuring the frequency control

Changing the setpoint source during operation
Example: Change-over from AI1 setpoint to MOP setpoint

Input signals

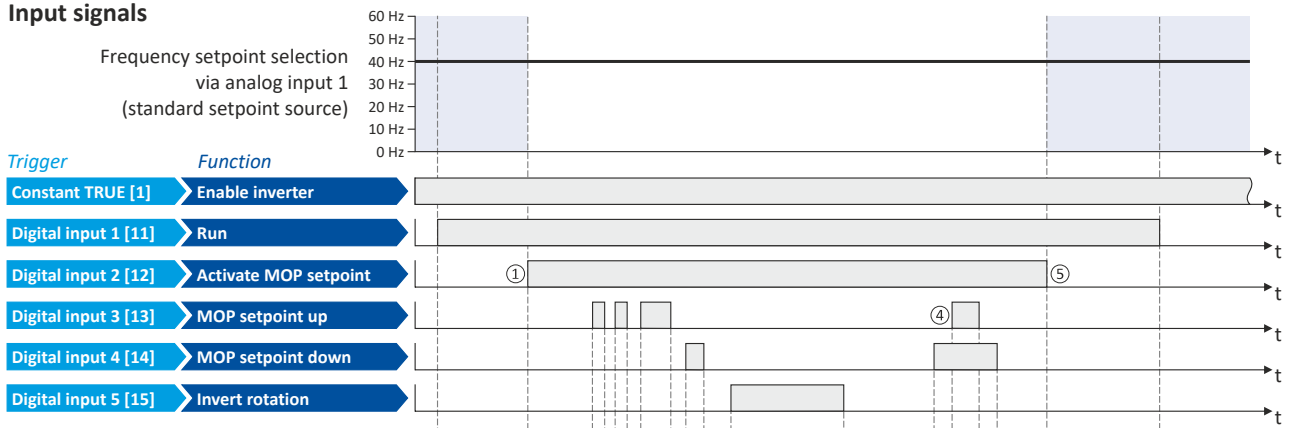

Output signals

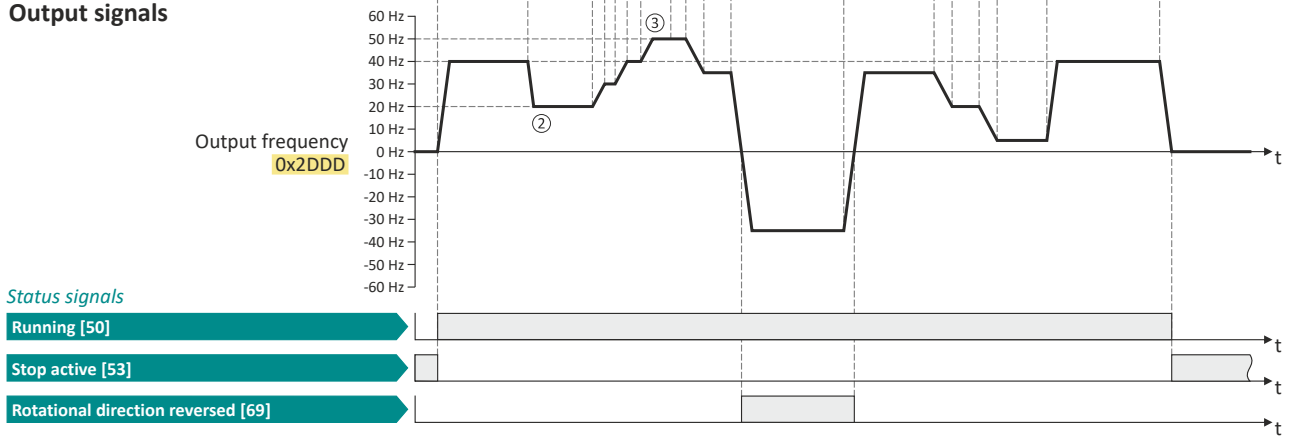

The status signals can be assigned to digital outputs. ▶ [Configure digital outputs](#) 247

- ① Change-over from analog input 1 (standard setpoint source) to MOP setpoint.
- ② The initial value for the motor potentiometer function depends on the setting in `0x4003 (P413.00)`. In this example, the "starting value" set in `0x4004:001 (P414.01)` is used (here: 20 Hz).
- ③ The MOP setpoint is maximally increased to the maximum frequency set in `0x2916 (P211.00)` (here: 50 Hz).
- ④ If "MOP setpoint up" and "MOP setpoint down" are requested at the same time, the MOP setpoint remains unchanged.
- ⑤ Change-over from MOP setpoint back to analog input 1 (standard setpoint source).

Configuring the frequency control

Change over to ramp 2 during operation



7.5 Change over to ramp 2 during operation

Two different ramps can be parameterised for the frequency setpoint. The change-over to the ramp 2 can be initiated manually or automatically.

Details

For ramp 2, the acceleration time 2 set in [0x2919 \(P222.00\)](#) and the deceleration time 2 set in [0x291A \(P223.00\)](#) apply.

The change-over to ramp 2 is effected automatically if the frequency setpoint (absolute value) \geq auto-changeover threshold [0x291B \(P224.00\)](#).

Input signals

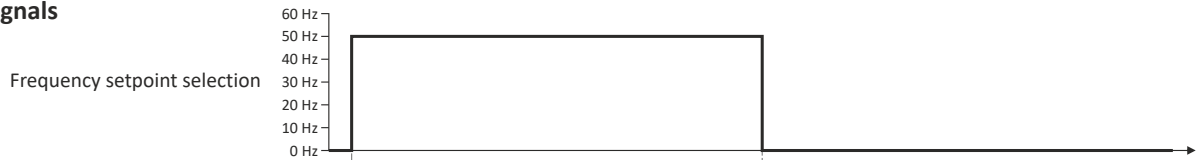

Output signals

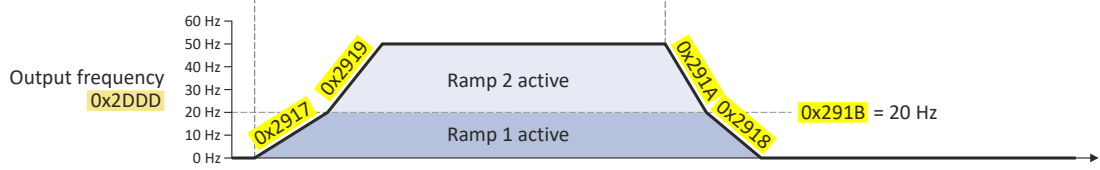

The "Activate ramp 2" [0x2631:039 \(P400.39\)](#) function is used to manually activate the acceleration time 2 and the deceleration time 2.

Parameter

Address	Name / setting range / [default setting]	Information
0x2919 (P222.00)	Acceleration time 2 (Accelerat.time 2) 0.0 ... [5.0] ... 3600.0 s	Acceleration time 2 for the operating mode "MS: Velocity mode". <ul style="list-style-type: none"> The acceleration time set refers to the acceleration from standstill to the maximum frequency set. In the case of a lower setpoint selection, the actual acceleration time is reduced accordingly. The acceleration time 2 is active if the frequency setpoint (absolute value) \geq auto switching threshold 0x291B (P224.00) or the trigger assigned to the function "Activate ramp 2" in 0x2631:039 (P400.39) = TRUE. The acceleration time 2 is also used for changing the MOP setpoint generated by the "motor potentiometer" function. Setting is not effective in the operating mode 0x6060 (P301.00) = "CiA: Velocity mode [2]".
0x291A (P223.00)	Deceleration time 2 (Decelerat.time 2) 0.0 ... [5.0] ... 3600.0 s	Deceleration time 2 for the operating mode "MS: Velocity mode". <ul style="list-style-type: none"> The deceleration time set refers to the deceleration from the maximum frequency set to standstill. In the case of a lower actual frequency, the actual deceleration time is reduced accordingly. The deceleration time 2 is active if the frequency setpoint (absolute value) \geq auto change-over threshold 0x291B (P224.00) or the trigger assigned to the function "Activate ramp 2" in 0x2631:039 (P400.39) = TRUE. The deceleration time 2 is also used for changing the MOP setpoint generated by the "motor potentiometer" function. Setting is not effective in the operating mode 0x6060 (P301.00) = "CiA: Velocity mode [2]".
0x291B (P224.00)	Auto-changeover threshold of ramp 2 (Ramp 2 thresh.) 0.0 ... [0.0] ... 599.0 Hz	Threshold for the automatic change-over to acceleration time 2 and deceleration time 2. <ul style="list-style-type: none"> The change-over is effected if the frequency setpoint (absolute value) \geq auto change-over threshold. With the setting 0, the automatic change-over function is deactivated.



Configuring the frequency control

Change over to ramp 2 during operation

Address	Name / setting range / [default setting]	Information
0x2631:039 (P400.39)	Function list: Activate ramp 2 (Function list: Activ. ramp 2) • Further possible settings: ▶ Trigger list 59	Assignment of a trigger for the "Activate ramp 2" function. Trigger = TRUE: activate acceleration time 2 and deceleration time 2 manually. Trigger = FALSE: no action / deactivate function again. Notes: <ul style="list-style-type: none"> • If the function is used and the assigned trigger = TRUE, the auto change-over threshold 0x291B (P224.00) for ramp 2 is deactivated. • Acceleration time 2 can be set in 0x2919 (P222.00). • Deceleration time 2 can be set in 0x291A (P223.00).
	0 Not connected	No trigger assigned (trigger is constantly FALSE).

Example for operating mode

- Switch S1 starts the motor in forward direction of rotation. Switch S1 in initial position stops the motor again.
- Switch S2 activates the acceleration time 2 and deceleration time 2.

Connection plan	Function
	Potentiometer R1 Frequency setpoint selection
	Switch S1 Run
	Switch S2 Activate ramp 2

Parameter	Name	Setting for this example
0x2631:001 (P400.01)	Enable inverter	Constant TRUE [1]
0x2631:002 (P400.02)	Run	Digital input 1 [11]
0x2631:004 (P400.04)	Reset fault	Not connected [0]
0x2631:039 (P400.39)	Activate ramp 2	Digital input 2 [12]
0x2824 (P200.00)	Control selection	Flexible I/O configuration [0]
0x2838:003 (P203.03)	Stop method	Standard ramp [1]
0x2860:001 (P201.01)	Frequency control: Default setpoint source	Analog input 1 [2]
0x2917 (P220.00)	Acceleration time 1	10.0 s
0x2918 (P221.00)	Deceleration time 1	10.0 s
0x2919 (P222.00)	Acceleration time 2	5.0 s
0x291A (P223.00)	Deceleration time 2	5.0 s

Configuring the frequency control

Change over to ramp 2 during operation

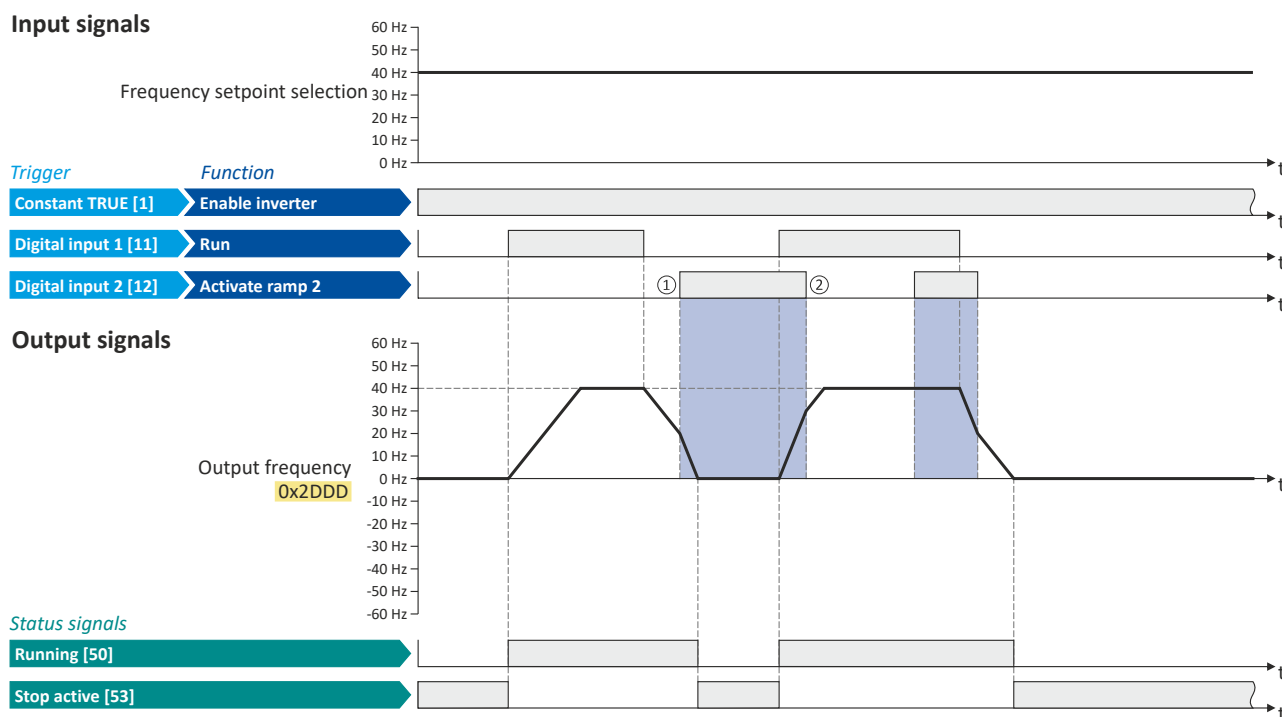

The status signals can be assigned to digital outputs. [▶ Configure digital outputs](#) 247



7.6 "Switch-off positioning" stop mode

This stopping method is an extension of the stopping method "Standard ramp". A relatively consistent stop position can be achieved regardless of the current motor speed after a stop command using the "switch-off positioning". In this case, depending on the current output frequency, the inverter delays the beginning of the down-ramping so that the number of motor revolutions is always the same from the stop command to standstill.

Details

The stop method can be selected in [0x2838:003 \(P203.03\)](#). ▶ [Stop behavior](#) 42

The number of motor revolutions to standstill depends on the rated speed of the motor, the set deceleration time and the set maximum frequency.

Example calculation:

- 4-pole 50 Hz motor with rated speed = 1500 rpm
- Maximum frequency [0x2916 \(P211.00\)](#) = 50.0 Hz
- Deceleration time 1 [0x2918 \(P221.00\)](#) = 10.0 s

$$\text{motor rotations} = \frac{1500 \text{ [rpm]}}{60 \text{ [s]}} \cdot \frac{\text{delay time [s]}}{2} = \frac{25}{1} \cdot \frac{10 \text{ [s]}}{2} = 125$$

Input signals



Output signals

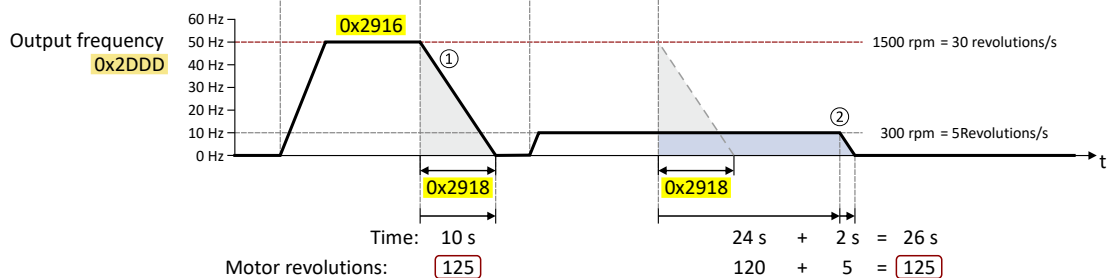

- ① The motor is immediately brought to a standstill with the set deceleration time following a stop command if the output frequency corresponds to the set maximum frequency.
In the example, the motor reaches a standstill after 125 revolutions.
- ② If the current output frequency is less than the maximum frequency, the inverter delays the beginning of the down-ramping in order to reach the same number of motor revolutions before standstill, depending on the actual output frequency.
In the example, the down-ramping is initiated with a delay of 24 seconds in order to reach the number of 125 motor revolutions before standstill.

Configuring the frequency control

"Switch-off positioning" stop mode



Notes:

- Two different ramps can be parameterized for the frequency setpoint. The speed compensation calculation is based on the deceleration time active at the time of the stop command, either deceleration time 1 or deceleration time 2.
- No speed compensation is implemented if the deceleration time for the quick stop is active.
- No adjustment is made to the speed compensation if the deceleration is changed from deceleration time 1 [0x2918 \(P221.00\)](#) to deceleration time 2 [0x291A \(P223.00\)](#) – or vice versa – during deceleration. The change-over is ignored.
- The threshold for automatic change-over to acceleration time 2 and deceleration time 2 is ignored during deceleration if this stop method is selected.
- If the motor accelerates or decelerates at the time of the stop command, the speed compensation is calculated based on the output frequency at that time.
- There is a configurable Stop threshold [0x291E:003 \(P226.03\)](#) that defines the speed range in which the stop function is active and NOT active. The stop threshold can be set from 0.0% to 100.0%. The percentage refers to the maximum frequency [0x2916 \(P211.00\)](#). The standard setting for the threshold value for the speed compensated stop is 10.0%. The stop function is active when coming to a standstill from a speed greater than or equal to the stop threshold. The stop function is NOT active when coming to a standstill from a speed lower than the stop threshold; in this case, normal deceleration occurs.
- The performance of speed compensation is dependent on several factors: the motor control type, the total capacity of the system mechanics, the mass inertia, the system friction, etc. These factors can influence the calculation of motor revolutions and the consistency. Since the mechanical and physical properties of the system cannot be influenced by the inverter, the system designer has to configure and test the speed compensation for suitability in the actual application.
- The general relative performance can be estimated on the part of the inverter based on the selected motor control type:



Configuring the frequency control

"Switch-off positioning" stop mode

Details

The stop method can be selected in [0x2838:003 \(P203.03\)](#). ▶ [Stop behavior](#) 42

The number of motor revolutions to standstill depends on the rated speed of the motor, the set deceleration time and the set maximum frequency.

Example calculation:

- 4-pole 50 Hz motor with rated speed = 1500 rpm
- Maximum frequency [0x2916 \(P211.00\)](#) = 50.0 Hz
- Deceleration time 1 [0x2918 \(P221.00\)](#) = 10.0 s

$$\text{motor rotations} = \frac{1500 \text{ [rpm]}}{60 \text{ [s]}} \cdot \frac{\text{delay time [s]}}{2} = \frac{25}{[s]} \cdot \frac{10 \text{ [s]}}{2} = 125$$

Input signals

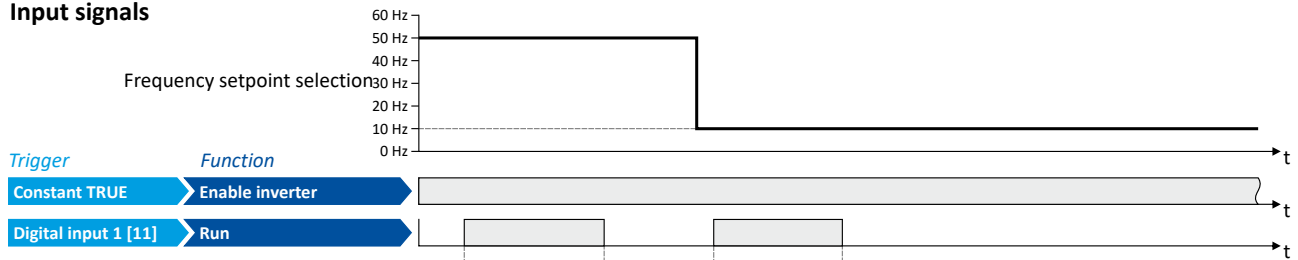

Output signals

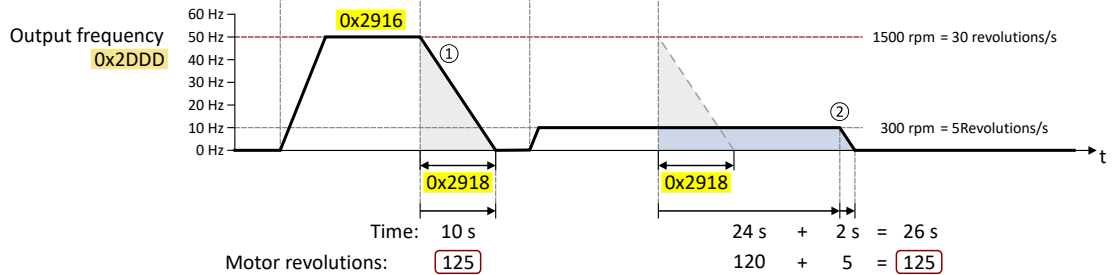

- ① The motor is immediately brought to a standstill with the set deceleration time following a stop command if the output frequency corresponds to the set maximum frequency.
In the example, the motor reaches a standstill after 150 revolutions.
- ② If the actual output frequency is less than the maximum frequency, the inverter delays the beginning of the down-ramping in order to reach the same number of motor revolutions to standstill, depending on the actual output frequency.
In the example, the down-ramping is initiated with a delay of 24 seconds in order to reach the number of 150 motor revolutions to a standstill.

Configuring the frequency control

"Switch-off positioning" stop mode



Notes:

- Two different ramps can be parameterized for the frequency setpoint. The calculation of the speed compensation is based on the active delay time at the point of the stop command, either delay time 1 or delay time 2.
- No speed compensation is implemented if the delay time is active for the quick stop.
- No adjustment to the speed compensation takes place if the delay is changed from Deceleration time 10x2918 (P221.00) to delay time 2 0x291A (P223.00) or vice versa during deceleration. The change-over is ignored.
- The threshold for automatic change-over to acceleration time 2 and deceleration time 2 is ignored during deceleration if this stop method is selected.
- If the motor accelerates or decelerates at the time of the stop command, the speed compensation is calculated based on the output frequency at that time.
- There is a configurable stop threshold 0x291E:003 (P226.03) which defines the speed range within which the stop function is active and NOT active. The stop threshold value is configurable from 0.0% to 100.0%. The percentage refers to the maximum frequency 0x2916 (P211.00). The standard setting for the threshold value for the speed-compensated stop is 10.0%. When stopping from a speed that is greater or equal to the stop threshold value, the stop function is active. When stopping from a speed that is smaller than the stop threshold value, the stop function is NOT active; normal deceleration takes place.
- The performance of the speed compensation depends on several factors: motor control type, total capacity of the system mechanics, mass inertia, system friction, etc. These factors can influence the calculation of motor revolutions and consistency. Since the mechanical and physical properties of the system cannot be influenced by the inverter, the system designer has to configure and test the speed compensation for suitability in the actual application.
- The general relative performance can be estimated on the part of the inverter based on the selected motor control type:

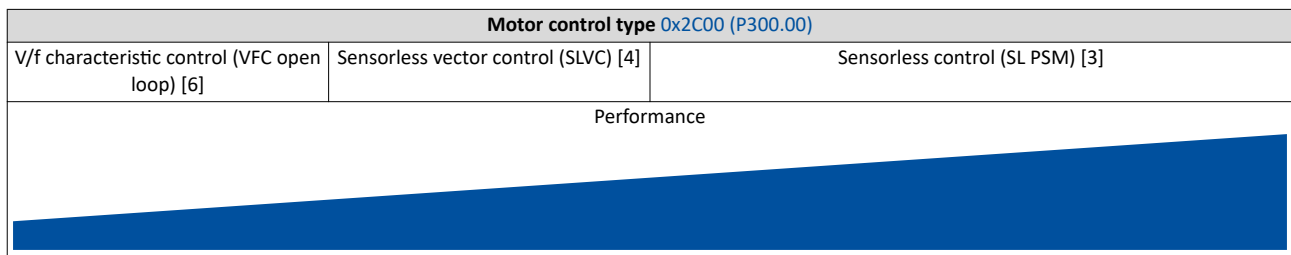

Parameter

Address	Name / setting range / [default setting]	Information
0x291E:003 (P226.03)	S-Ramp characteristic: Stop threshold (S-ramp char.: Stop threshold) 0.0 ... [10.0] ... 100.0 % • From version 05.03	<ul style="list-style-type: none"> • Configurable stop threshold value that defines the speed range in which the stop function is active and NOT active. • 100 % = maximum frequency (0x2916 (P211.00)).

Related topics

- ▶ Ramp times [80](#)
- ▶ Change over to ramp 2 during operation [138](#)



7.7 Setpoint diagnostics

The following parameters show the current setpoints of different setpoint sources.

Parameter

Address	Name / setting range / [default setting]	Information
0x282B:007	Inverter diagnostics: Default frequency setpoint <ul style="list-style-type: none">• Read only: x.x Hz• From version 03.00	Display of the frequency setpoint of the standard setpoint source set in 0x2860:001 (P201.01) .
0x282B:008	Inverter diagnostics: Preset frequency setpoint <ul style="list-style-type: none">• Read only: x.x Hz• From version 03.00	Display of the preset frequency setpoint selected via the four functions "Activate preset (bit 0)" ... "Activate preset (bit 3)". ▶ Setpoint presets □ 83
0x282B:009	Inverter diagnostics: Actual frequency setpoint <ul style="list-style-type: none">• Read only: x.x Hz• From version 03.00	Display of the currently selected frequency setpoint that is internally transferred to the motor control.
0x282B:010	Inverter diagnostics: Default PID setpoint <ul style="list-style-type: none">• Read only: x.xx PID unit• From version 03.00	Display of the PID control value of the standard setpoint source set in 0x2860:002 (P201.02) .
0x282B:011	Inverter diagnostics: Preset PID setpoint <ul style="list-style-type: none">• Read only: x.xx PID unit• From version 03.00	Display of the preset PID setpoint selected via the four functions "Activate preset (bit 0)" ... "Activate preset (bit 3)". ▶ Setpoint presets □ 83



8 Configuring the torque control

In general, the inverter is operated in a mode that controls the motor frequency. Alternatively, the inverter can be configured in such a way that it controls a motor torque within a defined frequency range.

Typical applications for such a torque control with frequency limitation are winders and packaging machines.

Preconditions

A torque control is only possible in the motor control type [0x2C00 \(P300.00\)](#) = "Sensorless vector control (SLVC) [4]". Thus, first this motor control type must be configured. For details see chapter "[Sensorless vector control \(SLVC\)](#)". [📖 165](#)

After configuration, one of the following optimisations must be carried out for torque control that is as precise as possible:

- ▶ [Automatic motor identification \(energized\)](#) [📖 210](#)
- ▶ [Automatic motor calibration \(non-energized\)](#) [📖 211](#)



8.1 Basic setting

In the following, the steps required for configuring the torque control are described.

1. Select the SLVC motor control type.
2. Carry out motor adjustment. ▶ [Configuring the motor control](#) 160
Set the operating mode "MS: Torque mode [-1]" in [0x6060 \(P301.00\)](#).
3. Select the standard setpoint source for the torque control in [0x2860:003 \(P201.03\)](#). 54.
4. Set the rated motor torque in [0x6076 \(P325.00\)](#).
5. Set the torque limits. ▶ [Torque limits](#) 150
6. Set the speed limitation. ▶ [Speed limitation](#) 152
7. Configure additional standard setpoint source. ▶ [Configure setpoint sources](#) 155
8. Optional: setting of the torque setpoint ramp time [0x2948:002 \(P336.02\)](#).

The following signal flow shows the internal setpoint logics:

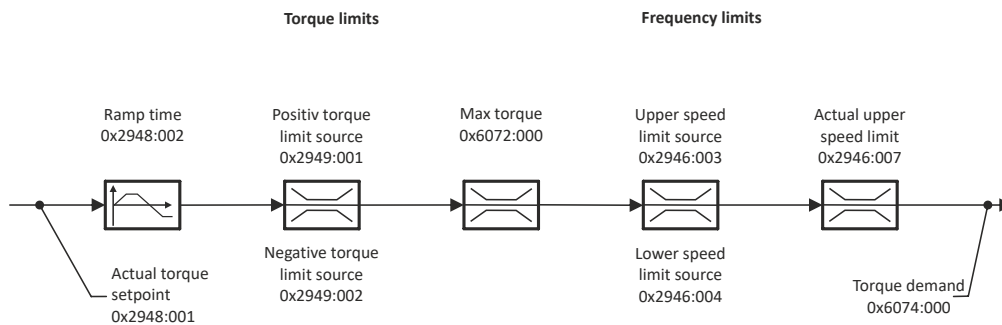

The torque control with frequency limitation is now active and the inverter responds to the torque setpoint given by the selected setpoint source.

Configuring the torque control

Basic setting

Standard setpoint source



8.1.1 Standard setpoint source

The selected "setpoint source" serves to provide the inverter with its setpoint. The setpoint source can be selected individually for each operating mode.

Possible setpoint sources are:

- Analog inputs
- Keypad
- Network
- Parameterisable setpoints (presets)
- "Motor potentiometer" function
- "Sequencer" function

Details

- For applications only requiring one setpoint, it is sufficient to define the standard setpoint source in [0x2860:003 \(P201.03\)](#).
- For applications requiring a change-over of the setpoint source during operation, the functions for setpoint change-over have to be configured accordingly. ▶ [Changing the setpoint source during operation](#) [125](#) ▶ [Configure setpoint sources](#) [155](#)



Configuring the torque control

Basic setting
Standard setpoint source

Parameter

Address	Name / setting range / [default setting]	Information
0x2860:003 (P201.03)	Torque control: Default setpoint source (Torque setp.src.) • From version 03.00	Selection of the standard setpoint source for operating mode "MS: Torque mode". • The selected standard setpoint source is always active in the operating mode 0x6060 (P301.00) = "MS: Torque mode [-1]" when no setpoint change-over to another setpoint source via corresponding triggers/functions is active.
	1 Keypad	The setpoint is specified locally by the keypad. • Default setting: 0x2601:003 (P202.03) • Use the ↑ and ↓ navigation keys to change the keypad setpoint (also during running operation).
	2 Analog input 1	The setpoint is defined as analog signal via the analog input 1. ▶ Analog input 1 240
	3 Analog input 2	The setpoint is defined as analog signal via the analog input 2. ▶ Analog input 2 244
	5 Network	The setpoint is defined as process data object via the network. ▶ Define setpoint via network 273
	11 Torque preset 1	For the setpoint selection, preset values can be parameterised and selected. ▶ Setpoint presets 156
	12 Torque preset 2	
	13 Torque preset 3	
	14 Torque preset 4	
	15 Torque preset 5	
	16 Torque preset 6	
	17 Torque preset 7	
	18 Torque preset 8	
	31 Segment preset 1	For the setpoint selection, the segment presets parameterised for the "sequencer" function can be selected as well. ▶ Sequencer 87
	32 Segment preset 2	
	33 Segment preset 3	
	34 Segment preset 4	
	35 Segment preset 5	
	36 Segment preset 6	
	37 Segment preset 7	
	38 Segment preset 8	
	50 Motor potentiometer	The setpoint is generated by the "motor potentiometer" function. This function can be used as an alternative setpoint control which is controlled via two signals: "MOP setpoint up" and "MOP setpoint down". ▶ Motor potentiometer (MOP) 156
	201 Internal value (from version 05.00)	Internal values of the manufacturer.
202 Internal value (from version 05.00)		
203 Internal value (from version 05.00)		
204 Internal value (from version 05.00)		
205 Internal value (from version 05.00)		
206 Internal value (from version 05.00)		

Configuring the torque control

Basic setting
Torque limits



8.1.2 Torque limits

The necessary parameterizations can be found in the table.

Details

The positive and negative torque limit can be set independently of each other. The torque limit is to be configured to the maximum torque. [▶ 0x6072 \(P326.00\)](#)

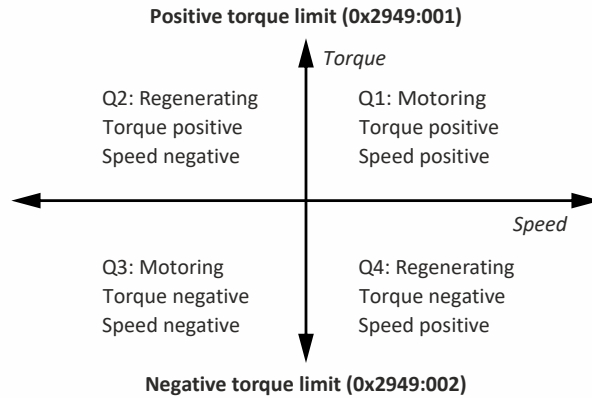

- Display of the current positive torque limit in [▶ 0x2949:004 \(P337.04\)](#).
- Display of the current negative torque limit in [▶ 0x2949:003 \(P337.03\)](#).



Regardless of the setting in [▶ 0x2949:001 \(P337.01\)](#) and [▶ 0x2949:002 \(P337.02\)](#), the maximum torque does not exceed the value configured in [▶ 0x6072 \(P326.00\)](#).

Parameter

Address	Name / setting range / [default setting]	Information
0x2949:001 (P337.01)	Torque limit source selection: Positive torque limit source (Trq. lim. source: Pos. torqlim src) • From version 03.00	Selection of the source for the positive torque limit source.
	0 Max torque	Positive torque limit source = Max. torque 0x6072 (P326.00) .
	1 Fixed Limit 0.0 %	Positive torque limit source = 0.0 %.
	2 Analog Input 1	The positive torque limit source is defined as analog signal via the analog input 1. ▶ Analog input 1 ☐ 240
	3 Analog Input 2	The positive torque limit source is defined as analog signal via the analog input 2. ▶ Analog input 2 ☐ 244
	4 Positive torque limit	Positive torque limit source = Positive torque limit 0x60E0 .
	5 Network target torque	The positive torque limit source is defined as process data object via network. ▶ Mappable parameters for exchanging setpoints and actual values ☐ 276
	201 Internal value (from version 05.03)	Internal values of the manufacturer.
	202 Internal value (from version 05.03)	
	203 Internal value (from version 05.03)	
	204 Internal value (from version 05.03)	
	205 Internal value (from version 05.03)	
206 Internal value (from version 05.03)		



Configuring the torque control

Basic setting
Torque limits

Address	Name / setting range / [default setting]	Information
0x2949:002 (P337.02)	Torque limit source selection: Negative torque limit source (Trq. lim. source: Neg. torqlim src) • From version 03.00	Selection of the source for the negative torque limit source.
	0 (-) Max torque	Negative torque limit source = (-) Max. torque 0x6072 (P326.00) .
	1 Fixed Limit 0.0 %	Negative torque limit source = 0.0 %.
	2 Analog Input 1	The negative torque limit source is defined as analog signal via the analog input 1. ▶ Analog input 1 □ 240
	3 Analog Input 2	The negative torque limit source is defined as analog signal via the analog input 2. ▶ Analog input 2 □ 244
	4 Negative torque limit	Negative torque limit source = Negative torque limit 0x60E1 .
	5 Network target torque	The negative torque limit source is defined as process data object via network. ▶ Mappable parameters for exchanging setpoints and actual values □ 276
	201 Internal value (from version 05.03)	Internal values of the manufacturer.
	202 Internal value (from version 05.03)	
	203 Internal value (from version 05.03)	
	204 Internal value (from version 05.03)	
205 Internal value (from version 05.03)		
206 Internal value (from version 05.03)		
0x60E0	Positive torque limit 0.0 ... [250.0] ... 3276.7 % • From version 02.00	Positive torque limit source for speed control with torque limitation. • 100 % = Rated motor torque. ▶ 0x6076 (P325.00)
0x60E1	Negative torque limit 0.0 ... [250.0] ... 3276.7 % • From version 02.00	Negative torque limit source for speed control with torque limitation. • 100 % = Rated motor torque ▶ 0x6076 (P325.00)

Configuring the torque control

Basic setting
Speed limitation



8.1.3 Speed limitation

The torque control controls the assigned torque setpoint within the set speed limits. The actual speed results from the load conditions of the application. For example, high speeds may occur in a torque control if no counter torque is available (load-free machine).

When the actual speed reaches the set speed limits, it is kept on the respective limit value. This function is also called "speed limitation".

Details

The lower and upper speed limit for speed limitation can be set independently of each other. They can also be defined via analog inputs or network.

Required parameter setting:

1. Select the source for the upper speed limit in [0x2946:003 \(P340.03\)](#).
 - Default setting: Maximum frequency-[0] [0x2916 \(P211.00\)](#)
 - In case of selection "Analog input 1 [2]": Set the setting range in [0x2636:002 \(P430.02\)](#) and [0x2636:003 \(P430.03\)](#).
 - In case of selection "Analog input 2 [3]": Set the setting range in [0x2637:002 \(P431.02\)](#) and [0x2637:003 \(P431.03\)](#).
 - In case of selection "Upper frequency limit [4]": Set the upper speed limit in [Hz] in [0x2946:005 \(P340.05\)](#).
 - In case of selection "Upper speed limit [5]": Set the upper speed limit in [vel. unit] in [0x2946:001 \(P340.01\)](#).
 - The current upper speed limit is displayed in [0x2946:007 \(P340.07\)](#).
2. Select the source for the lower speed limit in [0x2946:004 \(P340.04\)](#).
 - Default setting: (-) Maximum frequency-[0] [0x2916 \(P211.00\)](#)
 - In case of selection "Analog input 1 [2]": Set the setting range in [0x2636:002 \(P430.02\)](#) and [0x2636:003 \(P430.03\)](#).
 - In case of selection "Analog input 2 [3]": Set the setting range in [0x2637:002 \(P431.02\)](#) and [0x2637:003 \(P431.03\)](#).
 - In case of selection "Lower frequency limit [4]": Set the lower speed limit in [Hz] in [0x2946:006 \(P340.06\)](#).
 - In case of selection "Lower speed limit [5]": Set the lower speed limit in [vel. unit] in [0x2946:002 \(P340.02\)](#).
 - The output frequency is absolutely limited regardless of the setting [0x2946:003 \(P340.03\)](#) and [0x2946:004 \(P340.04\)](#) by [0x2916 \(P211.00\)](#) in the "Torque mode".
 - The current lower speed limit is displayed in [0x2946:008 \(P340.08\)](#).







Parameter

Address	Name / setting range / [default setting]	Information
0x2946:001 (P340.01)	Speed limitation: Upper speed limit (Speed limitation: Upper limit) -2147483647 ... [0] ... 2147483647 vel. unit <ul style="list-style-type: none">• From version 03.00	Upper limit for the speed limitation. <ul style="list-style-type: none">• Setting is only effective with the selection "Upper speed limit [5]" in 0x2946:003 (P340.03).• Entry via keypad and Lenze Tools is in rpm!• Via RPDO, the unit is vel. unit. and the scaling must be taken into account.• $\pm 480000 \text{ rpm} = \pm 2^{31} [\text{n-unit}]$
0x2946:002 (P340.02)	Speed limitation: Lower speed limit (Speed limitation: Lower limit) -2147483647 ... [0] ... 2147483647 vel. unit <ul style="list-style-type: none">• From version 03.00	Lower limit for speed limitation. <ul style="list-style-type: none">• Setting is only effective with the selection "Lower speed limit [5]" in 0x2946:004 (P340.04).• Entry via keypad and Lenze Tools is in rpm!• Via RPDO, the unit is vel. unit. and the scaling must be taken into account.• $\pm 480000 \text{ rpm} = \pm 2^{31} [\text{n-unit}]$



Configuring the torque control

Basic setting
Speed limitation

Address	Name / setting range / [default setting]	Information
0x2946:003 (P340.03)	Speed limitation: Upper speed limit source (Speed limitation: Uppspeed lim src) • From version 03.00	Selection of the source for the upper speed limit.
	0 Maximum frequency	Upper speed limit = Maximum frequency 0x2916 (P211.00).
	1 Fixed Limit 0.0 Hz	Upper speed limit = 0.0 Hz.
	2 Analog input 1	The upper speed limit is defined as analog signal via the analog input 1. ▶ Analog input 1  240
	3 Analog input 2	The upper speed limit is defined as analog signal via the analog input 2. ▶ Analog input 2  244
	4 Upper frequency limit	Upper speed limit = setting in 0x2946:005 (P340.05) in [Hz].
	5 Upper speed limit	Upper speed limit = setting in 0x2946:001 (P340.01) in [vel. unit].
	6 Network target velocity	The upper speed limit is defined as process data object via network. ▶ Mappable parameters for exchanging setpoints and actual values  276
	201 Internal value (from version 05.03)	Internal values of the manufacturer.
	202 Internal value (from version 05.03)	
	203 Internal value (from version 05.03)	
	204 Internal value (from version 05.03)	
205 Internal value (from version 05.03)		
206 Internal value (from version 05.03)		
0x2946:004 (P340.04)	Speed limitation: Lower speed limit source (Speed limitation: Lowspeed lim src) • From version 03.00	Selection of the source for the lower speed limit.
	0 (-) Maximum frequency	Lower speed limit = (-) Maximum frequency 0x2916 (P211.00).
	1 Fixed Limit 0.0 Hz	Lower speed limit = 0.0 Hz.
	2 Analog input 1	The lower speed limit is defined as analog signal via the analog input 1. ▶ Analog input 1  240
	3 Analog input 2	The lower speed limit is defined as analog signal via the analog input 2. ▶ Analog input 2  244
	4 Lower frequency limit	Lower speed limit = setting in 0x2946:006 (P340.06) in [Hz].
	5 Lower speed limit	Lower speed limit = setting in 0x2946:002 (P340.02) in [vel. unit].
	6 Network target velocity	The lower speed limit is defined as process data object via network. ▶ Mappable parameters for exchanging setpoints and actual values  276
	201 Internal value (from version 05.03)	Internal values of the manufacturer.
	202 Internal value (from version 05.03)	
	203 Internal value (from version 05.03)	
	204 Internal value (from version 05.03)	
205 Internal value (from version 05.03)		
206 Internal value (from version 05.03)		
0x2946:005 (P340.05)	Speed limitation: Upper frequency limit (Speed limitation: Upper freq.limit) Device for 50-Hz mains: -1000.0 ... [50.0] ... 1000.0 Hz Device for 60-Hz mains: -1000.0 ... [60.0] ... 1000.0 Hz • From version 03.00	Upper limit for the speed limitation. • Setting is only effective with the selection "Upper frequency limit [4]" in 0x2946:003 (P340.03).
0x2946:006 (P340.06)	Speed limitation: Lower frequency limit (Speed limitation: Lower freq.limit) Device for 50-Hz mains: -1000.0 ... [-50.0] ... 1000.0 Hz Device for 60-Hz mains: -1000.0 ... [-60.0] ... 1000.0 Hz • From version 03.00	Lower limit for speed limitation. • Setting is only effective with the selection "Lower frequency limit [4]" in 0x2946:004 (P340.04).
0x2946:007 (P340.07)	Speed limitation: Actual upper speed limit (Speed limitation: Act uppspeed lim) • Read only: x.x Hz • From version 03.00	Display of the current upper limit for speed limitation.
0x2946:008 (P340.08)	Speed limitation: Actual lower speed limit (Speed limitation: Act lowspeed lim) • Read only: x.x Hz • From version 03.00	Display of the current lower limit for speed limitation.

Configuring the torque control

Basic setting
Ramp time



8.1.4 Ramp time

Parameter

Address	Name / setting range / [default setting]	Information
0x2948:002 (P336.02)	Torque setpoint: ramp time (Torque setpoint: Ramp time) 0.0 ... [1.0] ... 60.0 s • From version 03.00	Ramp time for operating mode "MS: Torque mode". <ul style="list-style-type: none">• The torque setpoint is led via a ramp generator. This provides for a "smooth" switch-over between different setpoint sources.• The ramp time refers to max. torque 0x6072 (P326.00). At a lower setpoint selection, the actual ramp time is reduced accordingly.



8.2 Configure setpoint sources

The standard setpoint source for torque control can be selected in [0x2860:003 \(P201.03\)](#). This chapter describes the setting options for the various setpoint sources.

- Preset torque setpoint source: [Analog input 1](#). Set the setting range in [0x2636:011 \(P430.11\)](#) and [0x2636:012 \(P430.12\)](#) in this selection.
- In case of selection "Analog input 2 [3]": Set setting range in [0x2637:011 \(P431.11\)](#) and [0x2637:012 \(P431.12\)](#).
- Except for the network, the torque setpoint must be specified in percent with regard to the rated motor torque configured in [0x6076 \(P325.00\)](#).
- Via the network, the torque setpoint is specified via the mappable parameter [0x400B:008 \(P592.08\)](#) in [Nm / 2^{scaling factor}]. The scaling factor can be set in [0x400B:009 \(P592.09\)](#).
- Corresponding functions make it possible to change over to other setpoint sources during operation. More detailed information on this can be found in the chapter "Configuring frequency control": [▶ Changing the setpoint source during operation](#) [125](#)

The following setpoint sources are described in this chapter:

- [Keypad](#) [155](#)
- [Setpoint presets](#) [156](#)
- [Motor potentiometer \(MOP\)](#) [156](#)

Setpoint sources described in other chapters:

- [Sequencer](#) [87](#)
- [Analog input 1](#) [240](#)
- [Analog input 2](#) [244](#)
- Network: [Define setpoint via network](#) [273](#)

8.2.1 Keypad

For the manual setpoint selection via keypad, the following default settings are used:

Parameter

Address	Name / setting range / [default setting]	Information
0x2601:003 (P202.03)	Keypad setpoints: Torque setpoint (Keypad setpoints: Torque setp.) -400.0 ... [100.0] ... 400.0 % • From version 03.00	Default setting of the keypad setpoint for the operating mode 0x6060 (P301.00) = "MS: Torque mode [-1]". • 100 % = Rated motor torque 0x6076 (P325.00)

The increment for keypad setpoints can be adapted in [0x2862 \(P701.00\)](#) by pressing a keypad arrow key once.

A switch-over to the keypad during operation is also possible as an alternative to the standard setpoint source setting.

- ▶ [Example: Change-over from AI1 setpoint to keypad setpoint](#) [131](#)

Related topics

- ▶ [Keypad](#) [399](#)

Configuring the torque control

Configure setpoint sources
Setpoint presets



8.2.2 Setpoint presets

8 different torque setpoints (presets) can be parameterised for the torque control.

Parameter

Address	Name / setting range / [default setting]	Information
0x2912:001 (P452.01)	Torque setpoint presets: Preset 1 (Torque presets: Torque preset 1) -400.0 ... [100.0] ... 400.0 %	Parameterisable torque setpoints (presets) for operating mode "MS: Torque mode". <ul style="list-style-type: none">• 100 % = Rated motor torque 0x6076 (P325.00)
0x2912:002 (P452.02)	Torque setpoint presets: Preset 2 (Torque presets: Torque preset 2) -400.0 ... [100.0] ... 400.0 %	
0x2912:003 (P452.03)	Torque setpoint presets: Preset 3 (Torque presets: Torque preset 3) -400.0 ... [100.0] ... 400.0 %	
0x2912:004 (P452.04)	Torque setpoint presets: Preset 4 (Torque presets: Torque preset 4) -400.0 ... [100.0] ... 400.0 %	
0x2912:005 (P452.05)	Torque setpoint presets: Preset 5 (Torque presets: Torque preset 5) -400.0 ... [100.0] ... 400.0 %	
0x2912:006 (P452.06)	Torque setpoint presets: Preset 6 (Torque presets: Torque preset 6) -400.0 ... [100.0] ... 400.0 %	
0x2912:007 (P452.07)	Torque setpoint presets: Preset 7 (Torque presets: Torque preset 7) -400.0 ... [100.0] ... 400.0 %	
0x2912:008 (P452.08)	Torque setpoint presets: Preset 8 (Torque presets: Torque preset 8) -400.0 ... [100.0] ... 400.0 %	

A switch-over to a preset during operation is also possible as an alternative to the standard setpoint source setting.

▶ [Example: Change-over from keypad setpoint to preset 1 ... 7](#) [133](#)

8.2.3 Motor potentiometer (MOP)

The "Motor potentiometer" function can be used as an alternative setpoint control that is controlled via two functions: "MOP setpoint up" and "MOP setpoint down".

Details

The "[Motor potentiometer \(MOP\)](#)" function is described in detail in the chapter "Configuring frequency control". [85](#)

The following parameters of the function are only relevant for torque control.

Parameter

Address	Name / setting range / [default setting]	Information
0x4004:003 (P414.03)	MOP starting values: Torque (MOP start value: Torque) 0.0 ... [0.0] ... 1000.0 %	Starting value for operating mode "MS: Torque mode". <ul style="list-style-type: none">• This value is used as initial value if "Starting value [1]" is set in 0x4003 (P413.00).• 100 % = motor rated torque (0x6076 (P325.00)).
0x4009:003	MOP values saved: Torque <ul style="list-style-type: none">• Read only: x.x %	Display of the last MOP value saved internally for the operating mode "MS: Torque mode". <ul style="list-style-type: none">• This value is used as initial value if "Last value [0]" is set in 0x4003 (P413.00).• 100 % = motor rated torque (0x6076 (P325.00)).

A switch-over to the motor potentiometer during operation is also possible as an alternative to the standard setpoint source setting.

▶ [Example: Change-over from AI1 setpoint to MOP setpoint](#) [136](#)



8.3 Process input data (CiA 402 objects)

This object can be used for the mode 'MS: Torque mode'. The CiA402 mode 'Profile Torque mode' is not supported.

Parameter

Address	Name / setting range / [default setting]	Information
0x6060 (P301.00)	CiA: Operation mode (Operation mode) • Setting can only be changed if the inverter is disabled.	CiA: Operation mode
	-2 MS: Velocity mode	Vendor specific velocity mode ▶ Configuring the frequency control 78
	-1 MS: Torque mode (from version 03.00)	Vendor specific torque mode • Only possible in motor control type 0x2C00 (P300.00) = "Sensorless vector control (SLVC) [4]". ▶ Configuring the torque control 146
	0 No selection	No selection
	2 CiA: Velocity mode	CiA: Velocity mode ▶ CiA 402 device profile 285
0x6071	Set torque -3276.8 ... [0.0] ... 3276.7 %	Setting of the setpoint torque for the torque operating modes. • 100 % = Rated motor torque 0x6076 (P325.00) The inverter does not support the CiA 402 torque mode.

8.4 Process output data (CiA 402 objects)

This object can be used for the mode 'MS: Torque mode'. The CiA402 mode 'Profile Torque mode' is not supported.

Parameter

Address	Name / setting range / [default setting]	Information
0x6074	Internal set torque • Read only: x.x % • From version 02.00	Display of the internal set torque. • 100 % = Rated motor torque 0x6076 (P325.00).
0x6077 (P107.00)	Actual torque (Actual torque) • Read only: x.x %	Display of the actual torque. • 100 % = Rated motor torque 0x6076 (P325.00)



8.5 Setpoint diagnostics

The following parameters provide information on the setpoints set for torque control.

Parameter

Address	Name / setting range / [default setting]	Information
0x282B:012	Inverter diagnostics: Default torque setpoint <ul style="list-style-type: none"> • Read only: x.x % • From version 03.00 	Display of the torque setpoint of the standard setpoint source set in 0x2860:003 (P201.03) . <ul style="list-style-type: none"> • 100 % = Rated motor torque 0x6076 (P325.00)
0x282B:013	Inverter diagnostics: Preset torque setpoint <ul style="list-style-type: none"> • Read only: x.x % • From version 03.00 	Display of the preset torque setpoint selected via the four functions "Activate preset (bit 0)" ... "Activate preset (bit 3)". ▶ Setpoint presets □ 156
0x2948:001	Torque setpoint: Actual torque setpoint <ul style="list-style-type: none"> • Read only: x.x % • From version 03.00 	Display of the currently selected torque setpoint that is internally transferred to the motor control. <ul style="list-style-type: none"> • 100 % = Rated motor torque 0x6076 (P325.00)
0x2949:003 (P337.03)	Torque limit source selection: Actual positive torque limit (Trq. lim. source: Act postorqlim) <ul style="list-style-type: none"> • Read only: x.x % • From version 03.00 	Display of the current positive torque limit. <ul style="list-style-type: none"> • 100 % = Rated motor torque 0x6076 (P325.00)
0x2949:004 (P337.04)	Torque limit source selection: Actual negative torque limit (Trq. lim. source: Act negtorqlim) <ul style="list-style-type: none"> • Read only: x.x % • From version 03.00 	Display of the current negative torque limit. <ul style="list-style-type: none"> • 100 % = Rated motor torque 0x6076 (P325.00)
0x2DD5	Torque setpoint <ul style="list-style-type: none"> • Read only: x.xx Nm • From version 03.00 	Display of the current torque setpoint.



Configuring the feedback system

Synchronous motor: Pole position identification (PPI)
Monitoring the pole position identification

9 Configuring the feedback system

9.1 Synchronous motor: Pole position identification (PPI)

For the control of a permanent-magnet synchronous motor, the pole position – the angle between motor phase U and the field axis of the rotor – must be known.

Preconditions

In [0x2C00 \(P300.00\)](#) the motor control type "Sensorless control (SL PSM) [3]" is selected.

The "[Pole position identification \(PPI\) without movement](#)" function is available for the identification of the pole position for the inverter i5xx. [159](#)

9.1.1 Monitoring the pole position identification

If an error occurs during the pole position identification,

- the procedure is stopped without the settings being changed.
- the response set in [0x2C60](#) is effected.

Parameter

Address	Name / setting range / [default setting]	Information
0x2C60	PPI monitoring: Reaction	Selection of the response triggered by the occurrence of an error during the pole position identification (PLI). Associated error code: • 28961 0x7121 - Fault - Pole position identification ▶ Error types 456
	• From version 04.00	
	0 No response	
	1 Warning	
	2 Trouble	
3 Fault		

9.1.2 Pole position identification (PPI) without movement

The PLI function can also be used if no motor revolution is possible (holding brake active).

NOTICE

With an incorrect parameter setting and dimensioning of the inverter, the maximum permissible motor current may be exceeded during the pole position identification.

Possible consequence: Irreversible damage of the motor.

- ▶ Set the motor data correctly. ▶ [Motor data](#) [45](#)
- ▶ Only use an inverter that is performance-matched to the motor.

Conditions

- The wiring of the three motor phases and the motor encoder must be carried out according to the specifications from the mounting instructions.
- The inverter is ready for operation (no fault active).
- For the pole position identification (PPI) without movement, the motor must be at standstill.

Parameter

Address	Name / setting range / [default setting]	Information
0x2C63:001	PPI without movement: Execution	Start behavior (with or without pole position identification before the start).
	• Setting can only be changed if the inverter is disabled.	
	• From version 04.00	
0 Deactivated	No pole position is identified.	
2 After each enable	After every inverter release, the pole position is identified without any movement.	



10 Configuring the motor control

This chapter contains all functions and settings relevant for the motor control.

Basic procedure of commissioning the motor control

In the first step, the rated data of the motor must be set. The other steps depend on the respective application case.

There are several options for setting the motor data and optimizing the control loops. Basically, you can select between a manual and an automatic process. Whether a setting can be applied or not depends on the motor (Lenze motor yes/no) and the application. If possible, always use the possible setting listed first in the following diagram since this one leads to the most accurate results.

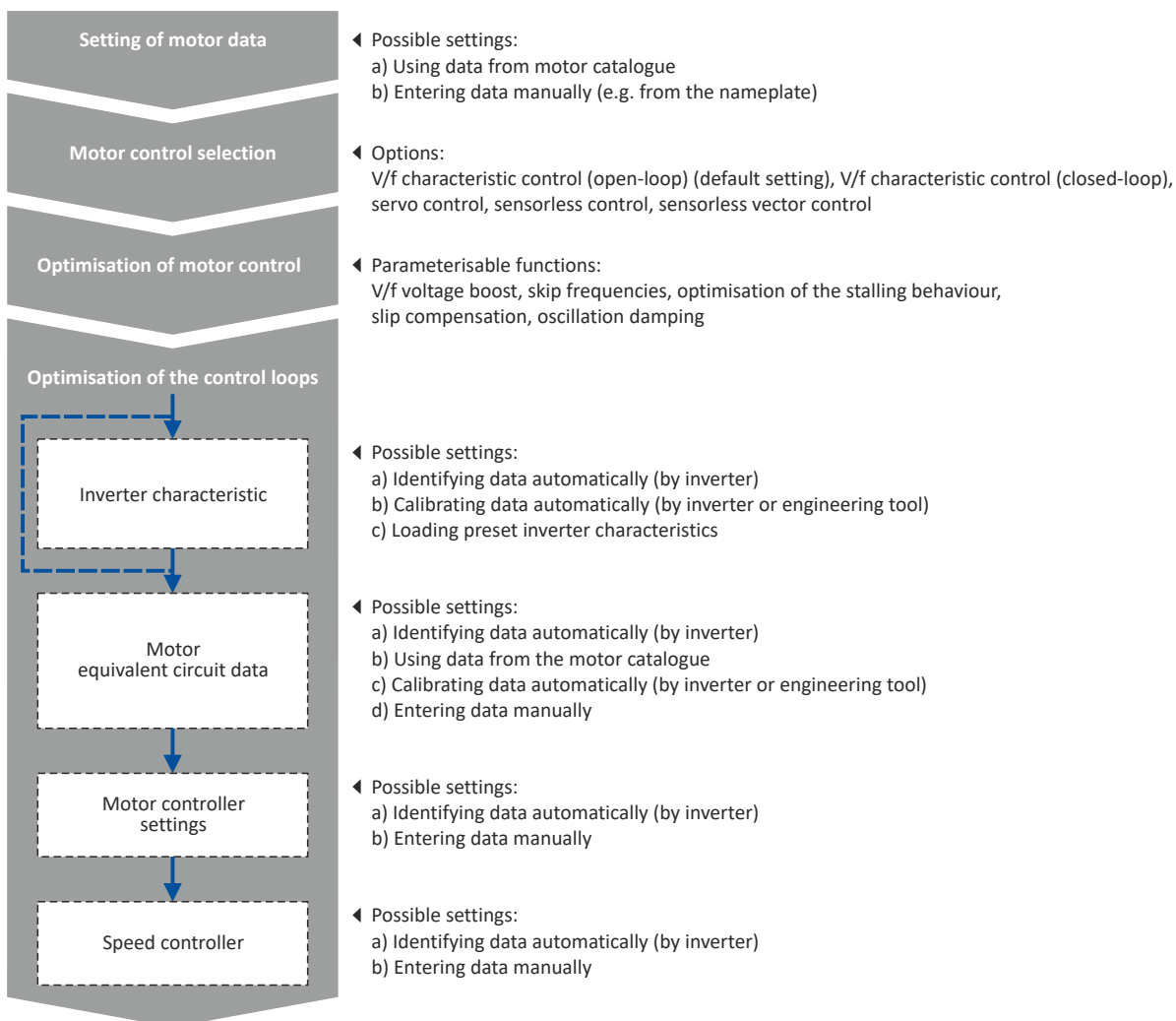

Related topics

Basic setting ▶ [Motor data](#) 45

Basic setting ▶ [Motor control mode](#) 48



Guide for this chapter

In the following subchapters, each motor control type is described in detail:

- ▶ [Sensorless control for synchronous motor \(SL-PSM\)](#) 162
- ▶ [Sensorless vector control \(SLVC\)](#) 165
- ▶ [V/f characteristic control for asynchronous motor \(VFC open loop\)](#) 167
- ▶ [Sensorless control for synchronous motor \(SLSM-PSM\)](#) 185

This chapter also contains information on the following subjects:

- ▶ [Parameterisable motor functions](#) 188
- ▶ [Options for optimizing the control loops](#) 207
- ▶ [Motor protection](#) 223

Configuring the motor control

Sensorless control for synchronous motor (SL-PSM)



10.1 Sensorless control for synchronous motor (SL-PSM)

The sensorless control for synchronous motors is based on a decoupled, separated control of the torque-producing current and the current aligned with the field. In contrast to the servo control, the actual speed value and rotor position are reconstructed via a motor model.

NOTICE

In case of this motor control type, an adjustable, constant current is injected in the lower speed range. If this current is higher than the rated motor current, the motor may heat up in the lower speed range. This effect increases if the motor is operated in the lower speed range for a longer period of time.

Possible consequence: Destruction of the motor by overheating

► Do not operate the motor for a longer period of time in the lower speed range.

Details

The motor model-based speed observer requires a rotating machine. Thus, as a matter of principle, the operational performance of the sensorless control for synchronous motors is divided into two ranges:

1. Low speed range ($|\text{setpoint speed}| < \text{lower limit } 0x2C11:001$)
 - In the range of low speeds, the speed of a synchronous motor cannot be observed. In this "Low speed range", controlled operation takes place: During the acceleration phase, the current setpoints of `0x2C12:001` and `0x2C12:002` are added and injected into the motor.
2. High speed range ($|\text{setpoint speed}| > \text{lower limit } 0x2C11:001$)
 - In this range, the rotor flux position and the speed are reconstructed by means of observation. The control is executed in a field-oriented way. Only the current required for generating the necessary torque is injected.

Pole position identification (PLI)

- For controlling a permanent-magnet synchronous motor, the pole position - the angle between the motor phase U and the field axis of the rotor - must be known.
- If the drive is at a standstill, the "pole position identification (PLI)" function is immediately activated after the inverter is enabled. ► [Synchronous motor: Pole position identification \(PPI\)](#)  159

Flying restart circuit

- From firmware version 4 onwards, a flying restart circuit for the synchronous motor up to speeds lower than half the rated speed is supported.
- If the flying restart circuit is to be used, set the start method "Flying restart circuit [2]" in `0x2838:001 (P203.01)`. Additional settings are not required for the flying restart circuit in the case of a sensorless control of a synchronous motor.

SL-PSM parameters

The parameters for this motor control type are calculated and set automatically while optimising the control loops.



10.1.1 Required commissioning steps

1. Activate motor control type: [0x2C00 \(P300.00\)](#) = "Sensorless control (SL PSM) [3]".
2. Carry out optimization of the control loops.
 - The default setting enables the operation of a power-adapted motor.
 - **An optimum operation of this motor control type requires an optimization of the control loops!**
 - Details: [► Options for optimizing the control loops](#) 207
3. Optionally: activate the flying restart circuit: [0x2838:001 \(P203.01\)](#)
4. Optionally for a speed control with torque limitation in operating mode [0x6060 \(P301.00\)](#) = "MS: Velocity mode [-2]":
 - Select the source in [0x2949:001 \(P337.01\)](#) for the positive torque limit source and set it accordingly.
 - Select the source in [0x2949:002 \(P337.02\)](#) for the negative torque limit source and set it accordingly.
5. Optionally for a speed control with torque limitation in operating mode [0x6060 \(P301.00\)](#) = "CiA: Velocity mode [2]":
 - Set the positive torque limit in [0x60E0](#)
 - Set the negative torque limit in [0x60E1](#).

10.1.2 Stalling protection

The stalling monitoring for the sensorless control of synchronous motors (SL-PSM) switches off the drive if the motor is about to "stall". A possible cause may be an overload of the motor.

Preconditions

The stalling monitoring only works in the controlled area and if the motor is not operated in the field weakening range.

Details

In order to detect the motor stalling, the cosine phi is used.

Example:

- For the cosine phi, the value "0.9" is set in [0x2C01:008 \(P320.08\)](#) according to the data given on the motor nameplate.
- The limit value for stalling monitoring is set in [0x2C11:006](#) to "80 %".
- Stalling monitoring is triggered if the current cosine phi is lower than 0.72 (80 % of 0.9).



If stalling monitoring is triggered, the "Trouble" error response takes place. If the operating mode "MS: Velocity mode [-2]" is set in [0x6060 \(P301.00\)](#), the motor automatically restarts if the trouble does not exist any more.

Parameter

Address	Name / setting range / [default setting]	Information
0x2C11:006	High speed range: Stall monitoring limit 0 ... [50] ... 65535 % <ul style="list-style-type: none">• From version 04.00	The stall monitoring limit refers to the cosine phi of the motor in percent.

Configuring the motor control

Sensorless control for synchronous motor (SL-PSM)
Expert settings



10.1.3 Expert settings

The parameters for this motor control type are calculated and set automatically while optimising the control loops.

Details

The motor model-based speed observer requires a rotating machine. Thus, the operational performance of the sensorless control for synchronous motors is divided into two ranges:

1. Low speed range ($|\text{setpoint speed}| < \text{lower limit } 0x2C11:001$)
 - In the range of low speeds, the speed of a synchronous motor cannot be observed. In this "Low speed range", controlled operation takes place: During the acceleration phase, the current setpoints of [0x2C12:001](#) and [0x2C12:002](#) are added and injected into the motor.
2. High speed range ($|\text{setpoint speed}| > \text{lower limit } 0x2C11:001$)
 - In this area, the rotor flux position and the speed are reconstructed by means of an observer. The control is executed in a field-oriented way. Only the current required for generating the necessary torque is injected.

Parameter

Address	Name / setting range / [default setting]	Information
0x2C11:001	High speed range: Lower limit 5 ... [10] ... 100 % • From version 02.00	Definition of the lower limit of the high speed range. • The lower limit has a permanent hysteresis of 5 %.
0x2C11:002	High speed range: Tracking controller gain 0 ... [200] ... 65535 % • From version 02.00	Gain factor for tracking the rotor position in the motor model.
0x2C11:003	High speed range: Tracking controller reset time 0.00 ... [6.00] ... 655.35 ms • From version 02.00	Reset time for tracking the rotor position in the motor model.
0x2C11:004	High speed range: Tracking controller decouple time 0.0 ... [200.0] ... 6553.5 ms • From version 02.00	Temporal hysteresis for the switching back and forth from the open-loop controlled to the closed-loop controlled operation.
0x2C12:001	SM low speed range: Acceleration current 5 ... [70] ... 400 % • From version 02.00	R.m.s. current value for acceleration processes in the lower velocity range. • 100 % = Rated motor current (0x6075 (P323.00)) • In the lower speed range and during the acceleration phase, the current setpoints of 0x2C12:001 and 0x2C12:002 are added and injected to the motor.
0x2C12:002	SM low speed range: Standstill current 5 ... [30] ... 400 % • From version 02.00	R.m.s. current value for processes without acceleration (for instance standstill or constant setpoint speed) in the lower velocity range. • 100 % = Rated motor current (0x6075 (P323.00)) • In the lower speed range and during the acceleration phase, the current setpoints of 0x2C12:001 and 0x2C12:002 are added and injected to the motor. Note! At the "100 %" setting, a motor current flows at standstill and at constant speed. The r.m.s. value of this motor current is greater than the rated motor current by a factor of $\sqrt{2}$ at standstill. The reason for this is that a DC current is injected into the synchronous motor at a standstill. The correct rated motor current flows when the motor turns.



10.2 Sensorless vector control (SLVC)

The sensorless (field-oriented) vector control for asynchronous motors is based on a decoupled control for the torque-producing and the field-producing current component. In addition, the actual speed is reconstructed by means of a motor model so that a speed sensor is not required.

Preconditions

- Sensorless vector control (SLVC) is only suitable for asynchronous motors.
- Multi-motor operation is not permitted for sensorless vector control (SLVC).

⚠ CAUTION!

Do not operate with hoisting units!

Operation of the sensorless vector control (SLVC) is **not** permissible for hoists!

▶ Do not operate the vector control with hoisting units.

Supported operating modes [0x6060 \(P301.00\)](#):

- "MS: Velocity mode [-2]"
- "MS: Torque mode [-1]"
- "CiA: Velocity mode [2]"

Details

Compared to the V/f characteristics, the sensorless vector control (SLVC) serves to achieve improved drive characteristics thanks to:

- higher torque throughout the entire speed range
- higher speed accuracy and smooth running properties
- higher efficiency

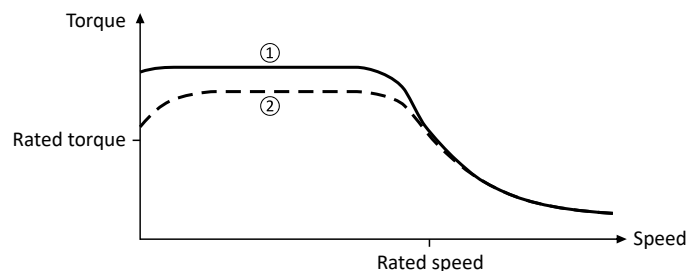

- ① Sensorless vector control (SLVC)
- ② [V/f characteristic control for asynchronous motor \(VFC open loop\)](#) [167](#)

10.2.1 Required commissioning steps

1. Activate motor control type: [0x2C00 \(P300.00\)](#) = "Sensorless vector control (SLVC) [4]".
2. Carry out optimisation of the control circuits.
 - **An optimum operation of this motor control type requires an optimisation of the control loops!**
 - Details: ▶ [Options for optimizing the control loops](#) [207](#)
3. Optionally for a speed control with torque limitation in operating mode [0x6060 \(P301.00\)](#) = "MS: Velocity mode [-2]":
 - Select the source in [0x2949:001 \(P337.01\)](#) for the positive torque limit source and set it accordingly.
 - Select the source in [0x2949:002 \(P337.02\)](#) for the negative torque limit source and set it accordingly.
4. Alternatively, the inverter can be configured in this motor control type in such a way that it controls a motor torque within a defined frequency range. For details, see chapter "[Configuring the torque control](#)". [146](#)

Configuring the motor control

Sensorless vector control (SLVC)
Expert settings

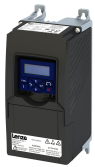

10.2.2 Expert settings

Parameter

Address	Name / setting range / [default setting]	Information
0x2B40:003	Q-Feedforward 0.00 ... [0.00] ... 10000.00 • From version 03.00	Feedforward control for the SLVC Q controller.
0x2B40:004	D-Feedforward 0.00 ... [0.00] ... 10000.00 • From version 03.00	Feedforward control of the SLVC-D controller.



Configuring the motor control

V/f characteristic control for asynchronous motor (VFC open loop)
Required commissioning steps

10.3 V/f characteristic control for asynchronous motor (VFC open loop)

The V/f characteristic control is a motor control for conventional frequency inverter applications. It is based on a simple and robust control mode for the operation of asynchronous motors with a linear or square-law load torque characteristic (e.g. fan). Because of the minimal parameterisation effort, such applications can be commissioned easily and quickly.

Preconditions

- The V/f characteristic control is only suitable for asynchronous motors.
- If you want to actuate a drive with a square-law V/f characteristic: Please always check whether the corresponding application is suitable for operation with a square-law V/f characteristic!
- Set the motor data according to the information on the nameplate of the motor. ▶ [Motor data](#) 45

10.3.1 Required commissioning steps

1. Activate motor control type: [0x2C00 \(P300.00\)](#) = "V/f characteristic control (VFC open loop) [6]".
2. Set limiting factors for the V/f characteristic:
 1. Rated mains voltage [0x2540:001 \(P208.01\)](#)
 2. Minimum frequency [0x2915 \(P210.00\)](#)
 3. Maximum frequency [0x2916 \(P211.00\)](#)
3. Set V/f characteristic data:
 1. Base voltage [0x2B01:001 \(P303.01\)](#)
 2. Base frequency [0x2B01:002 \(P303.02\)](#)
4. Select a characteristic shape suitable for the application in [0x2B00 \(P302.00\)](#).
5. Optional settings:
 - [Set voltage boost](#) 175
 - [Set slip compensation](#) 176
 - [Set oscillation damping](#) 178
 - [Optimising the stalling behaviour](#) 179
 - [Flying restart circuit](#) 182
 - [Additive voltage impression](#) 183
6. Optional: carry out optimisation of the control circuits.
 - An optimisation of the control circuits is not mandatory for this motor control type but may lead to better control operation. The control parameters should always be calculated if the motor power does not correspond to the inverter power in order to achieve optimum performance from the slip compensation. (It is sufficient to carry out the "NonEnergized" calculation.)
 - Details: ▶ [Options for optimizing the control loops](#) 207

10.3.2 Basic setting

The base voltage and the base frequency define the ratio of the two variables and thus the gradient of the V/f characteristic.

Parameter

Address	Name / setting range / [default setting]	Information
0x2B01:001 (P303.01)	V/f shape data: Base voltage (V/f shape data: Base voltage) 0 ... [230]* ... 5000 V * Default setting dependent on the model.	Base voltage and base frequency define the V/f ratio and thus the gradient of the V/f characteristic. <ul style="list-style-type: none"> • The V/f base voltage is usually set to the rated motor voltage. 0x2C01:007 (P320.07) • The V/f base frequency is usually set to the rated motor frequency. 0x2C01:005 (P320.05)
0x2B01:002 (P303.02)	V/f shape data: Base frequency (V/f shape data: Base frequency) Device for 50-Hz mains: 0 ... [50]* ... 1500 Hz Device for 60-Hz mains: 0 ... [60]* ... 1500 Hz * Default setting dependent on the model.	

Configuring the motor control

V/f characteristic control for asynchronous motor (VFC open loop)
Define V/f characteristic shape



10.3.3 Define V/f characteristic shape

Various characteristic shapes are available which are described in detail in the following subchapters.

Parameter

Address	Name / setting range / [default setting]	Information
0x2B00 (P302.00)	V/f characteristic shape (V/f charac.shape) <ul style="list-style-type: none">Setting can only be changed if the inverter is disabled.	Selection of the V/f characteristic shape for the adaptation to different load profiles.
	0 Linear	Linear characteristic for drives with constant load torque over the speed. ▶ Linear V/f characteristic □ 169
	1 Quadratic	Square-law characteristic for drives with a square-law load torque over the speed. <ul style="list-style-type: none">Square-law V/f characteristics are preferably used for centrifugal pumps and fan drives.Please always check whether the corresponding application is suitable for operation with a square-law V/f characteristic!If your pump drive or fan drive is not suitable for operation with a square-law V/f characteristic, use the linear V/f characteristic instead. ▶ Square-law V/f characteristic □ 170
	2 Multipoint (from version 03.00)	
	3 Eco (from version 02.00)	Linear characteristic with energy optimisation in the partial load operational range. ▶ Energy-saving V/f characteristic (VFC-Eco) □ 172
	4 Adaptive (from version 05.04)	



Configuring the motor control

V/f characteristic control for asynchronous motor (VFC open loop)
Define V/f characteristic shape

10.3.3.1 Linear V/f characteristic

The linear V/f characteristic leads to a constant torque.

Details

Select V/f characteristic control with linear characteristic:

1. Motor control mode **0x2C00 (P300.00)** = "V/f characteristic control (VFC open loop) [6]"
2. V/f characteristic shape **0x2B00 (P302.00)** = "Linear [0]"

Setting of the V/f characteristic:

- Limiting factors for the V/f characteristic are the rated mains voltage **0x2540:001 (P208.01)**, the minimum frequency **0x2915 (P210.00)** and the maximum frequency **0x2916 (P211.00)**.
- The base voltage **0x2B01:001 (P303.01)** is usually set to the rated motor voltage (motor nameplate data). The base voltage is preset to the rated mains voltage. This in turn is preset according to the product key of the inverter. ▶ [Mains voltage](#) 36
- The base frequency **0x2B01:002 (P303.02)** is usually set to the rated motor frequency (motor nameplate data).

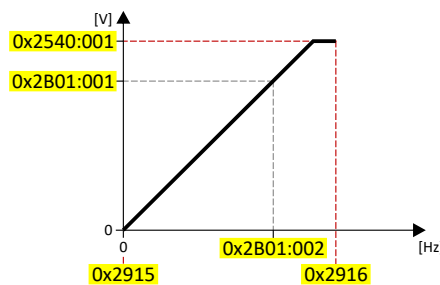

The actual output frequency can exceed the set maximum frequency if the gain for the slip compensation in **0x2B09:001 (P315.01)** is set to a value higher than 0.

Example

Mot power

- 400 V/50 Hz

Settings

- Maximum frequency 75 Hz
- Minimum frequency 10 Hz

Explanation

- Graphic on the left: The inverter is operated with a rated mains voltage of 400 V.
- Graphic on the right: The inverter is operated with a rated mains voltage of 480 V. This allows the output voltage to further increase above 50 Hz.

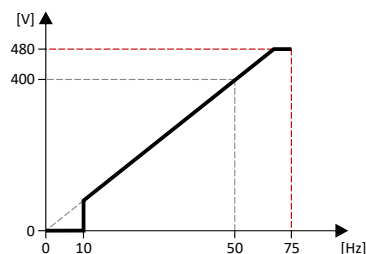
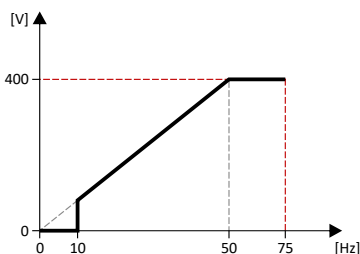

Parameter	Designation	Setting for this example
0x2540:001 (P208.01)	Rated mains voltage	400 Veff [1] (on the left) / 480 Veff [2] (on the right)
0x2915 (P210.00)	Minimum frequency	10 Hz
0x2916 (P211.00)	Maximum frequency	75 Hz
0x2B01:001 (P303.01)	Base voltage	400 V
0x2B01:002 (P303.02)	Base frequency	50 Hz

Configuring the motor control

V/f characteristic control for asynchronous motor (VFC open loop)
Define V/f characteristic shape



10.3.3.2 Square-law V/f characteristic

The square-law V/f characteristic is typically used in heating, ventilation and climate applications to control the speed of fans and centrifugal pumps.

Details

Each application that is provided with the features according to the affinity laws may possibly benefit from a square-law V/f characteristic.

The affinity laws describe the relation between the speed and other variables:

- The volume flow increases proportionately to the speed.
- The required pressure behaves proportionately to the square of the speed.
- The power input is proportionately to the cube of the speed. This means that already a minimal reduction of the speed may lead to substantial savings in energy consumption.

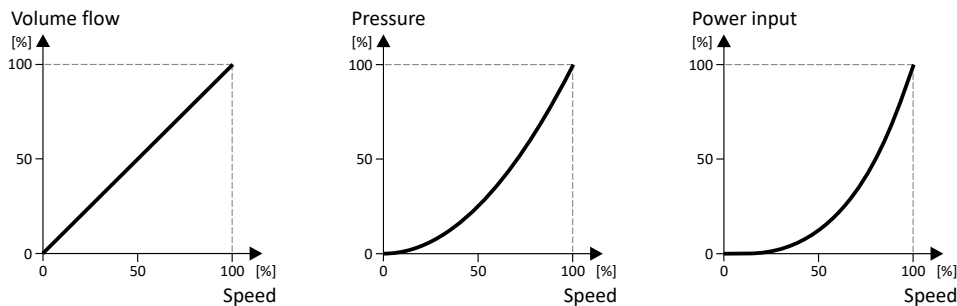

By approximation, the square-law V/f characteristic corresponds to the curve for power input shown above. At low frequencies, the voltage is reduced since due to the type of load a lower voltage is sufficient to generate the required power. All in all, this results in an energy-efficient system.

Select V/f characteristic control with square-law characteristic:

1. Motor control mode `0x2C00 (P300.00)` = "V/f characteristic control (VFC open loop) [6]"
2. V/f characteristic shape `0x2B00 (P302.00)` = "Quadratic [1]"

Setting of the V/f characteristic:

- Limiting factors for the V/f characteristic are the rated mains voltage `0x2540:001 (P208.01)`, the minimum frequency `0x2915 (P210.00)` and the maximum frequency `0x2916 (P211.00)`.
- The base voltage `0x2B01:001 (P303.01)` is usually set to the rated motor voltage (motor nameplate data). The base voltage is preset to the rated mains voltage. This in turn is preset according to the product key of the inverter. ▶ [Mains voltage](#) □ 36
- The base frequency `0x2B01:002 (P303.02)` is usually set to the rated motor frequency (motor nameplate data).

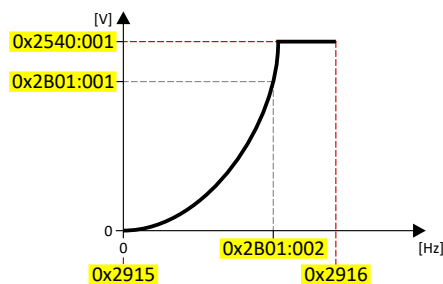

The actual output frequency can exceed the set maximum frequency if the gain for the slip compensation in `0x2B09:001 (P315.01)` is set to a value higher than 0.



Configuring the motor control

V/f characteristic control for asynchronous motor (VFC open loop)
Define V/f characteristic shape

10.3.3.3 Multipoint V/f characteristic

The multipoint V/f characteristic is based on the linear V/f characteristic. An additional characteristic point enables the adaptation to applications with special torque properties.

Details

This characteristic shape is suitable for applications that require a higher torque at lower speeds. The additional characteristic point can be configured in such a way that a higher voltage is provided in the lower frequency range of the characteristic. Otherwise, the same limits apply for the Multipoint characteristic as for the linear characteristic.

Select V/f characteristic control with Multipoint characteristic:

1. Motor control mode `0x2C00 (P300.00)` = "V/f characteristic control (VFC open loop) [6]"
2. V/f characteristic shape `0x2B00 (P302.00)` = "Multipoint [2]"

Setting of the V/f characteristic:

- Limiting factors for the V/f characteristic:
 - Rated mains voltage `0x2540:001 (P208.01)`
 - Minimum frequency `0x2915 (P210.00)`
 - Maximum frequency `0x2916 (P211.00)`
- The rated mains voltage is set as the base voltage `0x2B01:001 (P303.01)`. The rated mains voltage corresponds to the product key of the inverter. The base voltage is set to the rated motor voltage (motor nameplate specification).
- The base frequency `0x2B01:002 (P303.02)` is set to the rated motor frequency (motor nameplate data).
- The additional characteristic point is defined based on the parameters `0x2B01:003 (P303.03)` and `0x2B01:004 (P303.04)`.

Characteristic examples:

- Graphic on the left: the base voltage is set equal to rated mains voltage.
- Graphic on the right: the base voltage is set lower than the rated mains voltage.

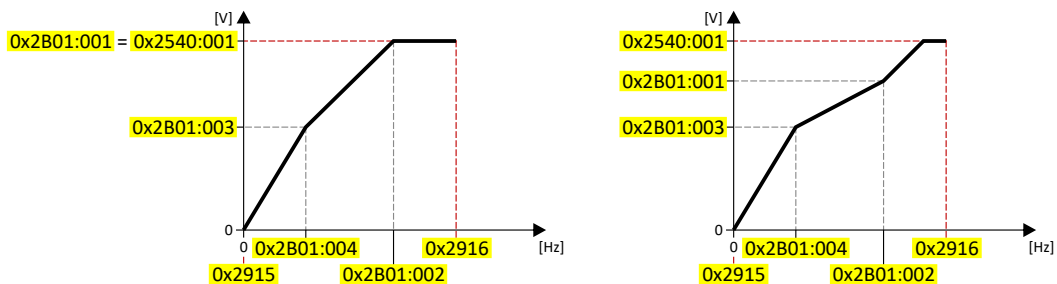

Parameter

Address	Name / setting range / [default setting]	Information
0x2B01:003 (P303.03)	V/f shape data: Midpoint voltage (V/f shape data: Midpoint voltage) 0 ... [0] ... 5000 V • From version 03.00	Definition of the medium characteristic point for user-definable V/f characteristic. • Only relevant if V/f characteristic shape <code>0x2B00 (P302.00)</code> is set = "Adaptive [2]".
0x2B01:004 (P303.04)	V/f shape data: Midpoint frequency (V/f shape data: Midpoint freq) 0 ... [0] ... 1500 Hz • From version 03.00	

Configuring the motor control

V/f characteristic control for asynchronous motor (VFC open loop)
 Define V/f characteristic shape



10.3.3.4 Energy-saving V/f characteristic (VFC-Eco)

In the case of the energy-saving V/f characteristic control (VFCEco), the motor voltage of the inverter is ascertained based on a linear characteristic as a function of the rotary field frequency or the motor speed to be generated. In addition, the motor is always operated in the optimum efficiency range by means of a $\cos\phi$ control and the resulting voltage dip (reduction of copper losses in the asynchronous motor). This is useful for energy efficiency with applications such as conveyors, where the torque and energy requirements are high during acceleration, but lower as soon as the load reaches the stationary speed.

Details

Select energy-saving V/f characteristic control with linear characteristic:

1. Motor control mode `0x2C00 (P300.00)` = "V/f characteristic control (VFC open loop) [6]"
2. V/f characteristic shape `0x2B00 (P302.00)` = "Eco [3]"

Setting of the V/f characteristic:

- The limiting factors for the V/f characteristic are the rated mains voltage `0x2540:001 (P208.01)`, the minimum frequency `0x2915 (P210.00)` and the maximum frequency `0x2916 (P211.00)`.
- The base voltage `0x2B01:001 (P303.01)` is usually set to the rated motor voltage (motor nameplate data). The base voltage is preset to the rated mains voltage. This in turn is preset according to the product key of the inverter. ▶ [Mains voltage](#) 36
- The base frequency `0x2B01:002 (P303.02)` is usually set to the rated motor frequency (motor nameplate data).

Eco efficiency range:

- The Eco efficiency range (grey) is between the V/f-standard characteristic (black) and the V/f Eco characteristic (green).
- The V/f Eco characteristic (green) is defined by the operating point that results from the minimum voltage `0x2B0D:001 (P330.01)` and the base frequency `0x2B01:002 (P303.02)`.
- The minimum voltage `0x2B0D:001 (P330.01)` has to be set in percent with reference to the base voltage `0x2B01:001 (P303.01)`.

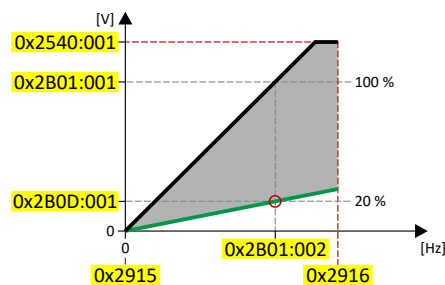

The actual output frequency can exceed the set maximum frequency if the gain for the slip compensation in `0x2B09:001 (P315.01)` is set to a value higher than 0.

Parameter

Address	Name / setting range / [default setting]	Information
<code>0x2B0D:001 (P330.01)</code>	VFC-ECO: Minimum voltage (VFC-ECO: Min. voltage) 20 ... [20] ... 100 % • From version 02.00	Defining the operating point of the V/f eco characteristic. The V/f eco characteristic defines the lower limit of the eco efficiency range. • 100 % = Base voltage <code>0x2B01:001 (P303.01)</code>
<code>0x2B0D:006 (P330.06)</code>	VFC-ECO: Cos phi actual value (VFC-ECO: Cos Phi actual) • Read only • From version 02.00	



10.3.3.5 User-definable V/f characteristic

The "user-definable V/f characteristic" is provided for the individual adjustment of the motor magnetization to the actual application if linear and square-law characteristics are not suitable.

- The characteristic is defined by means of 11 parameterizable grid points (voltage/frequency values).

Parameter

Address	Name / setting range / [default setting]	Information
0x2B02:001	Frequency grid points (x) user V/f characteristic: x1 = f01 -1500 ... [0] ... 1500 Hz	Freely parameterizable V/f characteristic (values for X axis). These settings define the adaptive frequency values.
0x2B02:002	Frequency grid points (x) user V/f characteristic: x2 = f02 -1500 ... [0] ... 1500 Hz	
0x2B02:003	Frequency grid points (x) user V/f characteristic: x3 = f03 -1500 ... [0] ... 1500 Hz	
0x2B02:004	Frequency grid points (x) user V/f characteristic: x4 = f04 -1500 ... [0] ... 1500 Hz	
0x2B02:005	Frequency grid points (x) user V/f characteristic: x5 = f05 -1500 ... [0] ... 1500 Hz	
0x2B02:006	Frequency grid points (x) user V/f characteristic: x6 = f06 -1500 ... [0] ... 1500 Hz	
0x2B02:007	Frequency grid points (x) user V/f characteristic: x7 = f07 -1500 ... [0] ... 1500 Hz	
0x2B02:008	Frequency grid points (x) user V/f characteristic: x8 = f08 -1500 ... [0] ... 1500 Hz	
0x2B02:009	Frequency grid points (x) user V/f characteristic: x9 = f09 -1500 ... [0] ... 1500 Hz	
0x2B02:010	Frequency grid points (x) user V/f characteristic: x10 = f10 -1500 ... [0] ... 1500 Hz	
0x2B02:011	Frequency grid points (x) user V/f characteristic: x11 = f11 -1500 ... [0] ... 1500 Hz	

Configuring the motor control

V/f characteristic control for asynchronous motor (VFC open loop)
 Define V/f characteristic shape



Address	Name / setting range / [default setting]	Information
0x2B03:001	Voltage grid points (y) user V/f characteristic: y1 = U01 (x = f01) 0.00 ... [0.00] ... 5000.00 V	Freely parameterizable V/f characteristic (values for Y axis). These settings define the adaptive voltage values.
0x2B03:002	Voltage grid points (y) user V/f characteristic: y2 = U02 (x = f02) 0.00 ... [0.00] ... 5000.00 V	
0x2B03:003	Voltage grid points (y) user V/f characteristic: y3 = U03 (x = f03) 0.00 ... [0.00] ... 5000.00 V	
0x2B03:004	Voltage grid points (y) user V/f characteristic: y4 = U04 (x = f04) 0.00 ... [0.00] ... 5000.00 V	
0x2B03:005	Voltage grid points (y) user V/f characteristic: y5 = U05 (x = f05) 0.00 ... [0.00] ... 5000.00 V	
0x2B03:006	Voltage grid points (y) user V/f characteristic: y6 = U06 (x = f06) 0.00 ... [0.00] ... 5000.00 V	
0x2B03:007	Voltage grid points (y) user V/f characteristic: y7 = U07 (x = f07) 0.00 ... [0.00] ... 5000.00 V	
0x2B03:008	Voltage grid points (y) user V/f characteristic: y8 = U08 (x = f08) 0.00 ... [0.00] ... 5000.00 V	
0x2B03:009	Voltage grid points (y) user V/f characteristic: y9 = U09 (x = f09) 0.00 ... [0.00] ... 5000.00 V	
0x2B03:010	Voltage grid points (y) user V/f characteristic: y10 = U10 (x = f10) 0.00 ... [0.00] ... 5000.00 V	
0x2B03:011	Voltage grid points (y) user V/f characteristic: y11 = U11 (x = f11) 0.00 ... [0.00] ... 5000.00 V	



10.3.4 Set voltage boost

The parameterisable voltage boost makes it possible to improve the starting performance for applications requiring a high starting torque.

Details

- In [0x2B12:001 \(P316.01\)](#), a permanent voltage boost can be set. ①
- In [0x2B12:002 \(P316.02\)](#), an additional voltage boost can be set for acceleration processes ②
- Reference for the percentage setting of the voltage boost is the base voltage [0x2B01:001 \(P303.01\)](#).

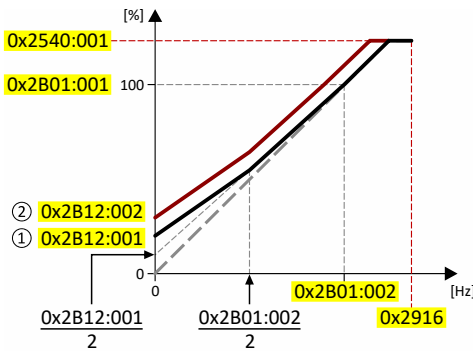

Parameter

Address	Name / setting range / [default setting]	Information
0x2B12:001 (P316.01)	V/f voltage boost: Fixed boost (V/f boosts: Fixed V/f boost) 0.0 ... [2.5]* ... 20.0 % * Default setting dependent on the model.	Constant voltage boost for V/f characteristic control without feedback. <ul style="list-style-type: none"> • 100 % = V/f base voltage 0x2B01:001 (P303.01) • For the purpose of optimizing the start behavior for applications requiring a high starting torque.
0x2B12:002 (P316.02)	V/f voltage boost: Boost at acceleration (V/f boosts: Dynam. V/f boost) 0.0 ... [0.0] ... 20.0 %	Additional voltage boost for V/f characteristic control without feedback. <ul style="list-style-type: none"> • 100 % = V/f base voltage 0x2B01:001 (P303.01) • This voltage boost is only active while the motor is accelerated. It then acts in addition to the fixed voltage boost set in 0x2B12:001 (P316.01).

Configuring the motor control

V/f characteristic control for asynchronous motor (VFC open loop)
Set slip compensation



10.3.5 Set slip compensation

The speed of an asynchronous motor decreases as load is applied. This load-dependent speed drop is called "slip". The slip compensation serves to counteract the load-dependent speed loss.

Preconditions

The function is only effective in the motor control type "V/f characteristic control (VFC open loop)".

In order for the function to generate the rated slip correctly the following parameters must be correctly set:

- Rated speed
- Rated frequency
- Number of pole pairs (automatically calculated from Rated speed and Rated frequency)

Details

The slip compensation increases or decreases the output frequency as a response to a load change. Thus, the slip is counteracted and the speed is kept constant.

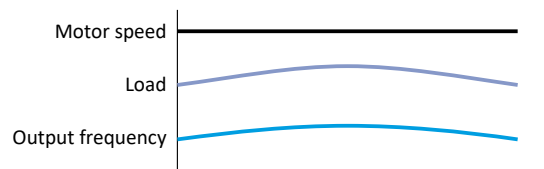

The rated slip required for the slip compensation is calculated by the inverter according to the following formula:

$$\text{Rated slip [\%]} = (1 - (\text{rated motor speed [rpm]} / (120 * \text{rated motor frequency [Hz]} / \text{number of poles}))) * 100$$

Calculation example:

- Rated motor speed = 1750 rpm
- Rated motor frequency = 60 Hz
- Number of poles = 2 * Number of pole pairs = 2 * 2 = 4
- Rated slip = $(1 - (1750 / (120 * 60 / 4))) * 100 = 2.77 \%$

The rated slip represents the reduction of the motor speed due to the motor load. At full speed and full load, the motor given in the example would rotate with 1750 rpm, which means 2.77 % below its synchronous speed of 1800 rpm. In order to compensate for this speed loss, the inverter increases the output frequency by the rated slip multiplied by the rated motor frequency. In the example, there is an increase in the output frequency at full load of $2.77 \% * 60 \text{ Hz} = 1.66 \text{ Hz}$.

In order to take into account load changes, the influence of the rated slip on the output frequency can be adapted in [0x2B09:001 \(P315.01\)](#). A setting of 100 % corresponds to the rated slip of the motor in the nominal operating point.

With reference to the example above and a setpoint frequency of 60 Hz:

- If [0x2B09:001 \(P315.01\)](#) = 100 %, the output frequency is = 61.66 Hz (60 Hz + 100 % * 1.66 Hz).
- If [0x2B09:001 \(P315.01\)](#) = 50 %, the output frequency is = 60.83 Hz (60 Hz + 50 % * 1.66 Hz).

Additionally, the filter time for the slip compensation can be adapted in [0x2B09:002 \(P315.02\)](#) if required. The preset filter time is adapted to typical motors. If full load or nearly full load oscillations or instabilities occur, we recommend an increase of the filter time.



Configuring the motor control

V/f characteristic control for asynchronous motor (VFC open loop)
Set slip compensation

Parameter

Address	Name / setting range / [default setting]	Information
0x2B09:001 (P315.01)	Slip compensation: Gain (Slip compens.: Slip: gain) -200.00 ... [100.00] ... 200.00 %	Adjustment in percent of the slip calculated. <ul style="list-style-type: none">• For instance required for deviations of the real motor data from the nameplate data.• A setting of 100 % corresponds to the rated slip of the machine in the nominal operating point.
0x2B09:002 (P315.02)	Slip compensation: Filter time (Slip compens.: Filter time) 1 ... [100] ... 6000 ms	Filter time for the slip compensation. <ul style="list-style-type: none">• The preset filter time is adapted to typical motors.
0x2C02:004 (P351.04)	Motor parameter (ASM): Slip frequency (ASM motor par.: Slip frequency) <ul style="list-style-type: none">• Read only: x.x Hz	Display of the rated slip determined.

Configuring the motor control

V/f characteristic control for asynchronous motor (VFC open loop)
Set oscillation damping



10.3.6 Set oscillation damping

The oscillation damping serves to reduce the oscillations during no-load operation which are caused by energy oscillating between the mechanical system (mass inertia) and the electrical system (DC bus). Furthermore, the oscillation damping can also be used to compensate for resonances.

Preconditions

The function is only effective in the motor control type "V/f characteristic control (VFC open loop)".

Restrictions

Observe the following restrictions:

- Damping is possible only for constant oscillations at a steady-state operating point.
- Oscillations occurring sporadically cannot be damped.
- Oscillation damping is not suitable for oscillations occurring during dynamic processes (e.g. accelerations or load changes).
- Oscillation damping is only active if the setpoint speed is greater than 10 rpm and the DC-bus voltage exceeds a value of 100 V.

Details

The determination of the oscillation is based on the active current. In order to obtain the alternating component of the active current, this current is differentiated. This signal is then passed through a PT1 filter.

Identification of the oscillation

Before the oscillation damping function can be parameterised, the oscillation has to be identified. One way to do this is to examine the motor current while oscillation damping is switched off (gain = 0 %). At steady-state operation, a constant current flows. If the drive oscillates, these oscillations are also visible on the motor current. It is therefore possible to determine the frequency and the amplitude of the oscillation from the alternating component of the motor current. In the following, this alternating component is referred to as "current oscillation".

Parameter setting

Set the gain of the oscillation signal according to the following equation:

$$0x2B0A:001 \text{ (P318.01)} = \text{current amplitude} * 100 \% / (\sqrt{2} * \text{maximum device current})$$

The default time constant of the PT1 filter is sufficient for most applications. If required, it is only possible to adapt the time constant via »EASY Starter«. Generally, the time constant must be set so that the oscillation is dampened and higher-frequency components are filtered from the signal. The time constant is given by the reciprocal value of double the current oscillation frequency:

$$0x2B0A:002 \text{ (P318.02)} = 1 / (2 * \text{oscillation frequency})$$

Parameter

Address	Name / setting range / [default setting]	Information
0x2B0A:001 (P318.01)	Oscillation damping: Gain (Oscillat. damp.: Gain) -400 ... [150] ... 400 %	Gain of the oscillation signal. <ul style="list-style-type: none">• With the setting 0, oscillation damping is deactivated.
0x2B0A:002 (P318.02)	Oscillation damping: Filter time (Oscillat. damp.: Filter time) 1 ... [30] ... 600 ms	Time constant of the PT1 filter.



Configuring the motor control

V/f characteristic control for asynchronous motor (VFC open loop)
Optimising the stalling behaviour

10.3.7 Optimising the stalling behaviour

If the motor is driven with frequencies above the rated motor frequency, the operating point is shifted to the "field weakening range". In this range, the motor voltage does not increase proportionately to the output frequency anymore. As a consequence, the inverter automatically reduces the maximum current since the full torque is not available anymore at these frequencies.

For special motors which enable an operation in the field weakening range, the behaviour in the field weakening range can be adapted to the motor with [0x2B0C \(P319.00\)](#).

DANGER!

Danger by incorrect parameterisation.

Possible consequences: damage to material assets and injury to persons

- ▶ Only change the default setting (0 Hz) in [0x2B0C \(P319.00\)](#) after consulting the motor manufacturer!
- ▶ Recommendation: Maintain default setting (0 Hz).

Preconditions

The function is only effective in the motor control type "V/f characteristic control (VFC open loop)".

Configuring the motor control

V/f characteristic control for asynchronous motor (VFC open loop)
 Optimising the stalling behaviour



Details

The operating range of an asynchronous motor consists of the voltage range ① and the field weakening range. The field weakening range is divided into two ranges:

- In the first range ②, the power can be kept constant without the motor stalling.
- The second field weakening range ③ is characterised by the fact that the maximum permissible stator current is reduced to prevent the motor from stalling.

Speed/torque curve of the asynchronous motor with two field weakening ranges

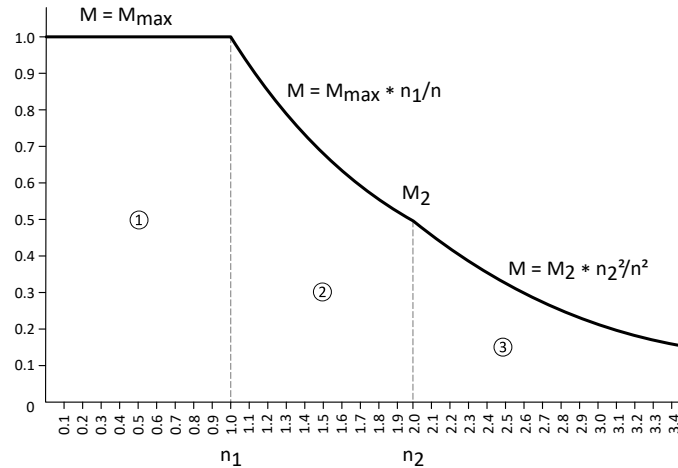

The override point (n_2, M_2) can be influenced with **0x2BOC (P319.00)**.

0x2BOC (P319.00) > 0 Hz:

- The maximum current characteristic is shifted to higher field frequencies by the frequency entered.
- The maximum permissible current and the maximum torque increase in the field weakening range.
- The risk of motor stalling increases.

0x2BOC (P319.00) < 0 Hz:

- The maximum current characteristic is shifted to lower field frequencies by the frequency entered.
- The maximum permissible current and the maximum torque are reduced in the field weakening range.
- The risk of motor stalling is reduced.

Parameter

Address	Name / setting range / [default setting]	Information
0x2BOC (P319.00)	Override field weakening (Field weak thold) -599.0 ... [0.0] ... 599.0 Hz	Offset of the override point for field weakening.
	Override field weakening (Field weak thold) -599.0 ... [-40.0] ... 599.0 Hz	



10.3.8 Torque limitation setting

Intro

For torque limitation in VFC mode, a maximum torque can be set for the inverter. If the motor torque exceeds the torque limit, the inverter modifies the output frequency to counteract this exceedance.



The quality of the torque limitation depends on the accuracy of the actual torque calculation.

Preconditions

The VFC torque limiter is only effective with the following motor control types:

- V/f control (open loop)

We recommend that you start by identifying the motor/inverter in order to achieve good performance!

▶ [Options for optimizing the control loops](#) 207

Details

The VFC torque limiter becomes active in V/f operation when the current motor torque exceeds the maximum torque. The limiter modifies the output frequency to counteract the exceedance.

The VFC torque limitation functions in a manner similar to the VFC I_{max} controller, but instead of the total current, the actual torque is taken into account.

When the maximum torque is exceeded:

- During motor operation, the VFC torque limiter reduces the output frequency.
- During generator operation, the VFC torque limiter increases the output frequency.

▶ [Configuring the torque control](#) 146

Parameter

Address	Name / setting range / [default setting]	Information
0x2B10:001	V/f torque limitation: Gain 0.00 ... [0.00] ... 655.35 %	Gain of the torque limitation. <ul style="list-style-type: none">• 0%: torque limitation is deactivated (standard setting)• 100%: same dynamic behaviour as the I_{max} controller (recommended setting for VFC torque activation)

Configuring the motor control

V/f characteristic control for asynchronous motor (VFC open loop)
Flying restart circuit



10.3.9 Flying restart circuit

The flying restart function makes it possible to restart a coasting motor on the fly during operation without speed feedback. Synchronicity between the inverter and the motor is coordinated so that the transition to the rotating drive is effected without jerk at the time of connection.

Preconditions

- Drive systems with speed feedback do not need a flying restart circuit because there is always a jerk-free synchronisation to the feedback speed.
- The flying restart circuit operates safely and reliably in case of drives with high centrifugal masses. If several motors with different centrifugal masses are connected to the inverter, the flying restart circuit must not be used.
- The flying restart circuit serves to identify rotating field frequencies of up to ± 200 Hz.

Required settings before the flying restart circuit is used:

1. The motor data must be set correctly. [▶ Motor data](#) [45](#)
2. The settings for the current controller and the flying restart controller must be adapted to the motor. The settings are made automatically if one of the following optimizations is carried out:
 - ▶ [Select motor from motor catalog](#) [46](#)
 - ▶ [Automatic motor identification \(energized\)](#) [210](#)
 - ▶ [Automatic motor calibration \(non-energized\)](#) [211](#)

Details

The inverter determines synchronicity by identifying the synchronous rotating field frequency. The "search" starts in the positive direction.

Duration:

- The flying restart process is determined within approx. 0.5 ... 1.5 seconds.
- The duration is influenced by the start frequency [0x2BA1:001 \(P718.01\)](#).

Setting the function:

1. As start behavior, set the selection "Flying restart circuit [2]" in [0x2838:001 \(P203.01\)](#).
 - Thus, every inverter enable causes a synchronisation to the rotating or standing motor.
 - After the inverter has been enabled, the motor can temporarily start or reverse if drives with low friction and low mass inertia are used.
 - If the inverter is operated with the default settings, no further settings are required for most applications.
2. If required, adapt the current [0x2BA1:001 \(P718.01\)](#) and the start frequency [0x2BA1:002 \(P718.02\)](#) for the flying restart circuit.
 - Setting notes can be found in the "Info" column for the respective parameter.

For diagnostic purposes, the frequency detected when the motor has been restarted on the fly is displayed in [0x2BA1:008 \(P718.08\)](#).

Parameter

Address	Name / setting range / [default setting]	Information
0x2BA1:001 (P718.01)	Flying restart circuit: Current (Flying restart: Current) 0 ... [30] ... 100 %	The current set here is injected into the motor during the flying restart process for the identification of the rotating field frequency. <ul style="list-style-type: none">• 100 % = Rated motor current 0x6075 (P323.00)• Reducing the current causes a reduction of the motor torque during the flying restart process. A short-time starting action or reversing of the motor is prevented with low flying restart currents.• If the current is set too low, the rotating field frequency cannot be identified correctly.• If the current is increased, this improves the robustness of the flying restart circuit.



Configuring the motor control

V/f characteristic control for asynchronous motor (VFC open loop)
Additive voltage impression

Address	Name / setting range / [default setting]	Information
0x2BA1:002 (P718.02)	Flying restart circuit: Start frequency (Flying restart: Start frequency) -599.0 ... [20.0] ... 599.0 Hz	The frequency set here defines the starting point for the flying restart process. <ul style="list-style-type: none"> The search starts in positive direction. The default setting is adjusted to standard asynchronous motors. In case of systems with a known search speed (e.g. torque-controlled drive systems that are to synchronise to a defined speed), the start frequency can be adapted for reducing the flying restart time.
0x2BA1:008 (P718.08)	Flying restart circuit: Flying restart frequency (Flying restart: Fl.res.frequency) • Read only: x.x Hz	Display of the found frequency at which the motor has been successfully restarted on the fly.

10.3.10 Additive voltage impression

This function serves to boost (or lower) the motor voltage from the process via an additive voltage setpoint in order to realise a load adjustment (for instance in case of winder applications).

NOTICE

A too high boost of the motor voltage may cause the motor to heat up strongly due to the resulting current.

- ▶ Avoid a too high boost of the motor voltage!

Details

At a constant field frequency, the output voltage of the inverter can be changed within a wide range.

Example: Adaptation of the voltage characteristic in case of V/f characteristic control as a function of the load:

- Clockwise rotation (CW) is operation in motor mode: Boost voltage.
- Counter-clockwise rotation (CCW) is operation in generator mode: Lower voltage.

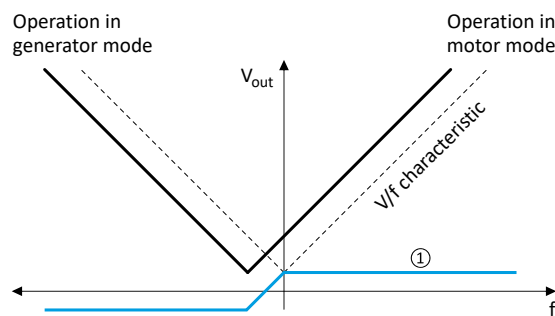

- ① Selecting an additive voltage setpoint

Parameter

Address	Name / setting range / [default setting]	Information
0x2B13:001	Additive voltage impression: Enable Function • From version 02.00	1 = enable function.
	0 Disable	
	1 Enable	

Configuring the motor control

V/f characteristic control for asynchronous motor (VFC open loop)
Additive voltage impression



Address	Name / setting range / [default setting]	Information
0x2B13:002	Additive voltage impression: Setpoint source • From version 02.00	Selection of the source for specifying the additive voltage setpoint. • 100 % = Rated voltage 0x2C01:007 (P320.07)
	1 Analog input 1	
	2 Analog input 2	
	3 Network	The additive voltage setpoint is defined via the mappable NetWordIN5 0x4008:005 (P590.05) data word.
	201 Internal value (from version 05.03)	Internal values of the manufacturer.
	202 Internal value (from version 05.03)	
	203 Internal value (from version 05.03)	
	204 Internal value (from version 05.03)	
205 Internal value (from version 05.03)		
206 Internal value (from version 05.03)		
0x2B13:003	Additive voltage impression: Actual voltage • Read only: x V • From version 02.00	Display of the current (boosted or lowered) voltage.
0x2B13:004	Additive voltage impression: Ramp time 0.0 ... [0.0] ... 3600.0 s • From version 06.02	Ramp time for ramping up the required additive voltage setpoint. • The ramp time is effective after each activation of the inverter. • The ramp time refers to the rated voltage 0x2C01:007 (P320.07) .

Example: Using the function with a 400-V inverter

With the settings indicated below, the motor is accelerated after the start to 50 Hz. As the base frequency, however, is set very high (here: 599 Hz), the motor voltage at 50 Hz only amounts to 20 VAC.

Now, the analog input 1 serves to change the motor voltage at constant frequency within a wide range:

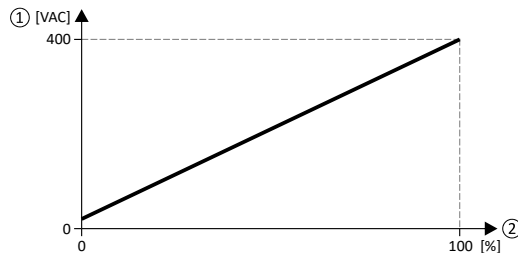

① Motor voltage

② Selection of an additive voltage setpoint in percent via analog input 1

The setting range (here: 0 ... 100 %) can be adapted via the parameters "Min PID value" and "Max PID value".

Parameter	Designation	Setting for this example
0x2636:004 (P430.04)	Analog input 1: Min PID value	0 %
0x2636:005 (P430.05)	Analog input 1: Max PID value	100 %
0x2860:001 (P201.01)	Frequency control: Default setpoint source	Frequency preset 1 [11]
0x2911:001 (P450.01)	Frequency setpoint presets: Preset 1	50 Hz
0x2B01:002 (P303.02)	V/f shape data: Base frequency	599 Hz
0x2B13:001	Additive voltage impression: Enable Function	Enable [1]
0x2B13:002	Additive voltage impression: Setpoint source	Analog input 1 [1]



10.4 Sensorless control for synchronous motor (SLSM-PSM)

The sensorless control for synchronous motors is based on a decoupled, separated control of the torque-producing current and the current aligned with the field. In contrast to the servo control with position encoder, the actual speed value and rotor position are reconstructed via a motor model.

Compared to the sensorless "SL-PSM" control, the "SLSM-PSM" control offers the following advantages:

- Lower power consumption and more torque through HF injection in the lower speed range
- Easier commissioning by supporting automatic identification/calibration of the motor

Details

The operating behavior of sensorless control for synchronous motors is divided into two areas due to its principle:

- Low speed range: An unobservable range of low speeds.
- High speed range: Range with high speeds in which the rotor position can be calculated for field-oriented control by means of an observer.

The motor model-based approach to control includes two different methods for the low-speed range:

- Low-speed method [0x2C13](#) = "Carrier based [1]"
 - This method is not suitable for all permanently excited synchronous motors! The position detection requires an anisotropy in the inductors of the motor. From approx. 5 % difference between the inductance L_d ([0x2C03:005 \(P352.05\)](#)) and the inductance L_q ([0x2C03:006 \(P352.06\)](#)) this method can be used.
 - Permanently excited synchronous motors with buried magnets and distributed stator winding are particularly suitable. Permanently excited synchronous motors with concentrated windings tend to be less suitable.
 - With this method, a high-frequency carrier signal is applied in the low-speed range ("HF injection"). With this active method it is possible to detect the rotor position and to operate the motor speed controlled. This results in a higher starting torque with lower power consumption. The control is field oriented.



Motor phase failure detection is deactivated if HF injection is active in the low-speed range.

- Low-speed method [0x2C13](#) = "i/f based [2]"
 - This method is suitable for all permanently excited synchronous motors.
 - With this method, a controlled start-up occurs in the low-speed range.

Behavior in the high-speed range

- In the high-speed range ($|\text{setpoint speed}| > \text{lower limit } [0x2C11:001](#) \text{ or } (|\text{actual speed}| > [0x2C10:008](#))$) the rotor flux position and the speed is reconstructed by means of observation.
- The control is field oriented. Only the current required for generating the necessary torque is injected.

Pole position identification (PPI)

- For controlling a permanent-magnet synchronous motor, the pole position - the angle between the motor phase U and the field axis of the rotor - must be known.
- If the drive is at standstill, the "pole position identification (PPI)" function is immediately activated after the inverter is enabled. ▶ [Synchronous motor: Pole position identification \(PPI\)](#) 159

Flying restart circuit

- A flying restart circuit for the synchronous motor up to the rated speed is supported.
- If the flying restart circuit is to be used, set the start method "Flying restart circuit [2]" in [0x2838:001 \(P203.01\)](#). Additional settings are not required for the flying restart circuit in the case of a sensorless control of a synchronous motor.

Configuring the motor control

Sensorless control for synchronous motor (SLSM-PSM)
Required commissioning steps



10.4.1 Required commissioning steps

1. Activate motor control type: [0x2C00 \(P300.00\)](#) = "Sensorless control for synchronous motors (SLSM-PSM) [8]".
2. [Automatic motor identification \(energized\)](#)  210
 - **Mandatory for this motor control mode in order to determine the equivalent circuit data and calculate the parameters for encoderless operation with HF injection.**
3. Optionally for a speed control with torque limitation in operating mode [0x6060 \(P301.00\)](#) = "MS: Velocity mode [-2]":
 - Select the source in [0x2949:001 \(P337.01\)](#) for the positive torque limit source and set it accordingly.
 - Select the source in [0x2949:002 \(P337.02\)](#) for the negative torque limit source and set it accordingly.
4. Optionally for a speed control with torque limitation in operating mode [0x6060 \(P301.00\)](#) = "CiA: Velocity mode [2]":
 - Set the positive torque limit in [0x60E0](#)
 - Set the negative torque limit in [0x60E1](#).



10.4.2 Expert settings

Low-speed method **0x2C13** = "Carrier based [1]"

- In the unobservable range of low speeds ($|\text{actual speed}| < \text{0x2C10:008}$), a high-frequency carrier signal is switched on ("HF injection").
- The amplitude of this carrier signal is set in **0x2C10:001**. Larger values lead to better position detection. If the value is set too small, then the amplitude of the carrier signal is automatically increased after controller release. This ensures that HF injection always works regardless of the setting in **0x2C10:001**.
- The two parameters **0x2C10:001** and **0x2C10:008** can be identified automatically or set manually. The settings for the two parameters are not provided by the motor catalog!

Low-speed method **0x2C13** = "i/f based [2]"

- A controlled start-up takes place when $|\text{setpoint speed}| < \text{lower limit } \text{0x2C11:001}$.
- During the acceleration phase, the **0x2C12:001** and **0x2C12:002** current setpoints are added and impressed on the motor.
- This method is suitable for all permanently excited synchronous motors.

NOTICE

With the Low-Speed method **0x2C13** = "i/f based [2]", an adjustable constant current is impressed in the lower speed range. If this current is higher than the rated motor current, the motor may heat up in the lower speed range. This effect increases if the motor is operated in the lower speed range for a longer period of time.

Possible consequence: Destruction of the motor by overheating

- ▶ Do not operate the motor for a longer period of time in the lower speed range.
- ▶ For detecting and monitoring the motor temperature, we recommend a temperature feedback via PTC thermistor or thermal contact.

For the motor model-based approach to control, two different methods are available for the low-speed range in **0x2C13**.

Parameter

Address	Name / setting range / [default setting]	Information
0x2C13	SLSM-PSM low speed method • From version 03.00	Selection of the method for the lower speed range in sensorless control for synchronous motor (SLSM-PSM).
	1 Carrier based	Encoderless operation with HF injection. Not suitable for MCS motors!
	2 i/f based	Encoderless operation with controlled start-up. Universally suitable for all motors. Note! With this low-speed method, the set torque limits are only active in the higher speed range (closed-loop mode)!
0x2C10:001	HF amplitude 0.0 ... [50.0] ... 400.0 V • From version 02.00	Setting of the HF amplitude for low speed method "Carrier based".
0x2C10:008	HF injection range 0.5 ... [6.0] ... 50.0 % • From version 05.03	Setting of the speed range with HF injection for low speed method "Carrier based".

Configuring the motor control

Parameterisable motor functions
Skip frequencies



10.5 Parameterisable motor functions

10.5.1 Skip frequencies

By means of the three parameterisable skip frequencies, critical frequencies can be suppressed which lead to mechanical resonances in the system.

Details

A blocking zone is active as soon as the frequency for this blocking zone is set to a value \neq "0 Hz".

- The frequency defines the center of the range to be masked out. ①
- The bandwidth defines its total size. ②

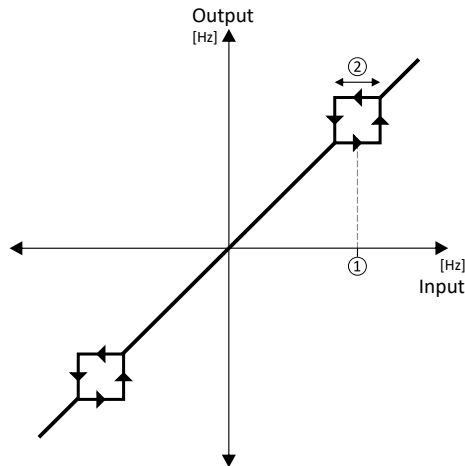

Example: For a blocking zone, the frequency is set to 20 Hz and the bandwidth to 10 Hz. These settings mask out the range from 15 Hz to 25 Hz.

Notes:

- Skip frequencies are absolute values. With the setting "20 Hz", at the same time also the skip frequency "-20 Hz" is defined.
- The inverter accelerates/decelerates the motor through the range to be masked out. Continuous operation within this range is not possible.
- A blocking zone is not active if its bandwidth is set to "0 Hz".

Adjacent and overlapping areas:

- Example on the left: If the ranges are closely spaced, the ranges are passed through as shown.
- Example on the right: If the ranges overlap, the lowest and highest value form a new range. In the status display `0x291F:016`, both ranges are shown as active.

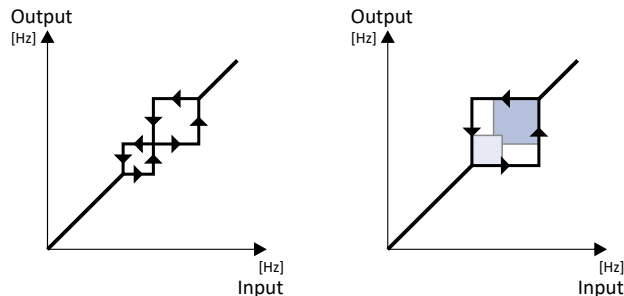



Configuring the motor control

Parameterisable motor functions
Skip frequencies

Valid and invalid ranges:

- Example on the left: Skip frequency = 5 Hz, bandwidth = 10 Hz
→ Valid range (starts at ≥ 0)
- Example on the right: Skip frequency = 4 Hz, bandwidth = 10 Hz
→ Invalid range (starts at < 0); is thus ignored.

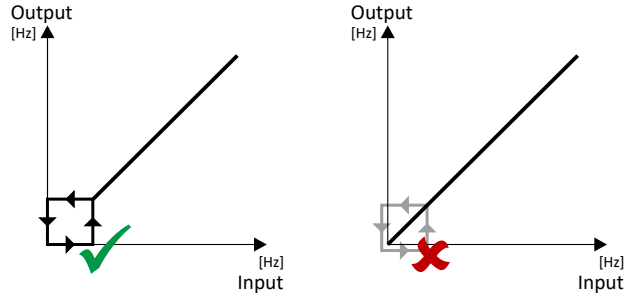

Parameter

Address	Name / setting range / [default setting]	Information
0x291F:001 (P317.01)	Skip frequencies: Skip frequency 1 (Skip frequencies: Skip frequency 1) 0.0 ... [0.0] ... 599.0 Hz	Center of frequency range 1 which is to be skipped.
0x291F:002 (P317.02)	Skip frequencies: Skip bandwidth 1 (Skip frequencies: Skip bandwidth 1) 0.0 ... [0.0] ... 10.0 Hz	Size of frequency range 1 which is to be skipped.
0x291F:003 (P317.03)	Skip frequencies: Skip frequency 2 (Skip frequencies: Skip frequency 2) 0.0 ... [0.0] ... 599.0 Hz	Center of frequency range 2 which is to be skipped.
0x291F:004 (P317.04)	Skip frequencies: Skip bandwidth 2 (Skip frequencies: Skip bandwidth 2) 0.0 ... [0.0] ... 10.0 Hz	Size of frequency range 2 which is to be skipped.
0x291F:005 (P317.05)	Skip frequencies: Skip frequency 3 (Skip frequencies: Skip frequency 3) 0.0 ... [0.0] ... 599.0 Hz	Center of frequency range 3 which is to be skipped.
0x291F:006 (P317.06)	Skip frequencies: Skip bandwidth 3 (Skip frequencies: Skip bandwidth 3) 0.0 ... [0.0] ... 10.0 Hz	Size of frequency range 3 which is to be skipped.
0x291F:016	Skip frequencies: Status • Read only	Bit-coded status display of the skip frequencies.
	Bit 0 Blocking zone 1 active	
	Bit 1 Blocking zone 2 active	
	Bit 2 Blocking zone 3 active	
	Bit 4 Frequency above blocking zone 1	
	Bit 5 Frequency above blocking zone 2	
	Bit 6 Frequency above blocking zone 3	
	Bit 8 Blocking zone 1 invalid	
	Bit 9 Blocking zone 2 invalid	
	Bit 10 Blocking zone 3 invalid	
0x291F:032	Skip frequencies: Input frequency • Read only: x.xx Hz	Display of the skip filter input frequency.
0x291F:033	Skip frequencies: Output frequency • Read only: x.xx Hz	Display of the skip filter output frequency.

Configuring the motor control

Parameterisable motor functions
DC braking



10.5.2 DC braking

The "DC braking" function generates a braking torque by injecting a DC current into the motor. The function can be used to shorten the braking of a load with high mass inertia. Another application is holding the motor shaft before starting or while stopping.

NOTICE

Avoid long-time activation of the "DC braking" function with a high braking current or a high braking voltage!

Possible consequence: thermal motor overload.

- ▶ Only use the "DC braking" function with applications in which the load is only occasionally stopped.
- ▶ Do not activate the "DC braking" function longer than necessary.

Preconditions

The "DC braking" function can only be activated if the inverter is enabled.

This function is not available for the SL-PSM motor control mode **0x2C00 (P300.00)**.

Details

The function can be used as follows:

1. Automatically when the motor is started.
2. Automatically when the motor is stopped.
3. Manually (via the flexible I/O configuration).

The three options can also be combined, for instance automatic DC braking when starting and stopping the motor.

For further details and configuration examples, see the following subchapter:

- ▶ [Example: Automatic DC braking when starting the motor](#) 191
- ▶ [Example: Automatic DC braking when stopping the motor](#) 192
- ▶ [Activating DC braking manually](#) 194
- ▶ [Migration of Lenze Inverter Drives 8200/8400](#) 196

Parameter

Address	Name / setting range / [default setting]	Information
0x2B84:001 (P704.01)	DC braking: Current (DC braking: Current) 0.0 ... [0.0] ... 200.0 %	Braking current for DC braking. <ul style="list-style-type: none">• 100 % = Rated motor current 0x6075 (P323.00)
0x2B84:002 (P704.02)	DC braking: Automatic hold time (DC braking: Hold time autom.) 0.0 ... [0.0] ... 1000.0 s	Hold time for automatic DC braking. <ul style="list-style-type: none">• The "Automatic DC braking" function is active for the time set here.• 1000.0 = infinite Note! Do not set this parameter to the value "1000.0" (infinite) if the DC braking is used during the start. The "Infinite" setting can be used to lock the rotor for an indefinite time while a stop is active. However, ensure here that the longer DC braking does not cause a thermal overload of the motor!
0x2B84:003 (P704.03)	DC braking: Automatic operating threshold (DC braking: Threshold autom.) 0.0 ... [0.0] ... 599.0 Hz	Operating threshold for automatic DC braking. <ul style="list-style-type: none">• With the setting 0, the "Automatic DC braking" function is deactivated.
0x2B84:004 (P704.04)	DC braking: Demagnetization time (DC braking: Demagnet. time) 0 ... [100] ... 150 % <ul style="list-style-type: none">• From version 04.00	In the default setting, the DC braking is activated after the standard demagnetising time has elapsed. This parameter can be used to adapt the time. <ul style="list-style-type: none">• 100 % = Default demagnetization time 0x2B84:005 (P704.05) Note! A too short demagnetising time can cause an overcurrent error!
0x2B84:005 (P704.05)	DC braking: Default demagnetization time (DC braking: Def. demag. time) <ul style="list-style-type: none">• Read only: x ms• From version 04.00	Display of the standard demagnetising time as a setting help for the user. <ul style="list-style-type: none">• This time is calculated by the inverter: Demagnetising time = 7 * rotor time constant



Configuring the motor control

Parameterisable motor functions
DC braking

Address	Name / setting range / [default setting]	Information
0x2B84:006 (P704.06)	DC braking: Inverter disable (DC braking: Inverter disable)	1 = behaviour in case of automatic DC braking as with the Lenze Inverter Drives 8200/8400. The behaviour of the Lenze Inverter Drives 8200/8400 in case of automatic DC braking is different: In case of these inverters, after the auto DCB hold time has elapsed, the motor is deenergised (by means of pulse inhibit) until the setpoint exceeds the auto DCB operating threshold. In order to make a migration to the i500 inverter series easier, the setting "1" serves to activate the same behaviour in the i500.
	0 Deactivated	
	1 Activated	

10.5.2.1 Example: Automatic DC braking when starting the motor

In order that the DC braking is automatically active when the motor is started, the start method "DC braking [1]" must be set in [0x2838:001 \(P203.01\)](#).

- The DC braking is carried out with the braking current set in [0x2B84:001 \(P704.01\)](#).
- Only after the hold time [0x2B84:002 \(P704.02\)](#) has elapsed, the motor is accelerated to the setpoint.

Parameter	Designation	Setting for this example
0x2631:001 (P400.01)	Enable inverter	Digital input 1 [11]
0x2631:002 (P400.02)	Run	Digital input 2 [12]
0x2631:004 (P400.04)	Reset fault	Not connected [0]
0x2838:001 (P203.01)	Start method	DC braking [1]
0x2860:001 (P201.01)	Frequency control: Default setpoint source	Frequency preset 1 [11]
0x2911:001 (P450.01)	Frequency setpoint presets: Preset 1	40 Hz
0x2B84:001 (P704.01)	Current	50 %
0x2B84:002 (P704.02)	Automatic hold time	10 s

Input signals

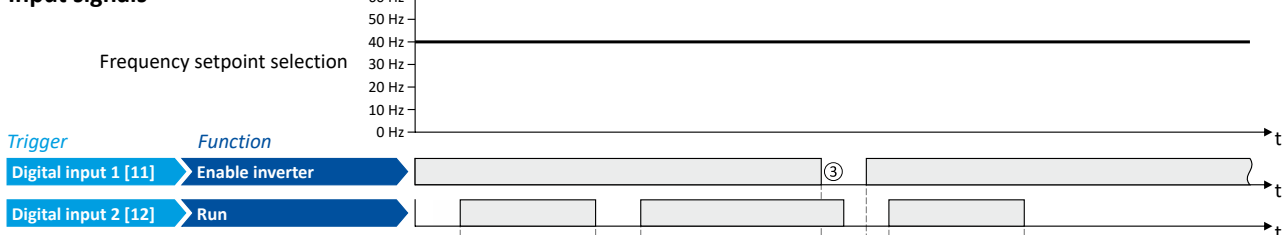

Output signals

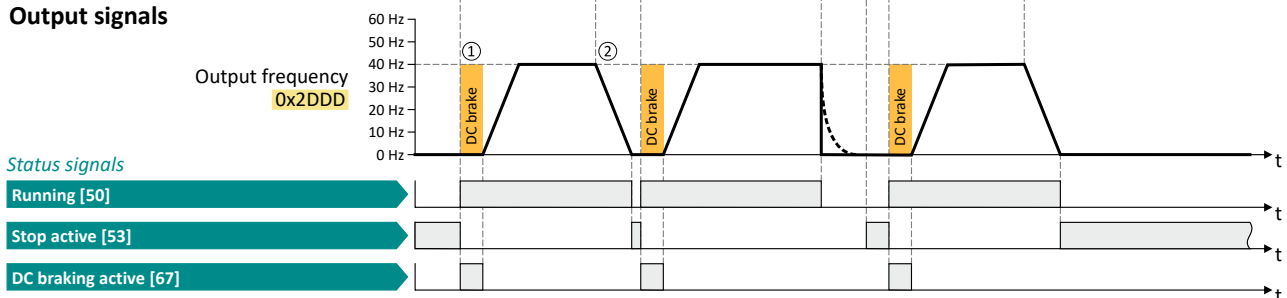

The status signals can be assigned to digital outputs. ▶ [Configure digital outputs](#) 247

- ① After the start command, the DC braking is active. Only after the hold time [0x2B84:002 \(P704.02\)](#) has elapsed, the motor is accelerated to the setpoint.
- ② The motor is stopped with the stop method set in [0x2838:003 \(P203.03\)](#). In the example: Stop with standard ramp.
- ③ If the inverter is disabled, the motor coasts.

Configuring the motor control

Parameterisable motor functions
DC braking



10.5.2.2 Example: Automatic DC braking when stopping the motor

In order that the DC braking is automatically active when the motor is stopped, the corresponding operating threshold must be set in [0x2B84:003 \(P704.03\)](#).

- After a stop command, the motor is first decelerated as set. Once the output frequency falls below the set operating threshold, the inverter stops the deceleration and activates DC braking.
- DC braking is carried out with the braking current set in [0x2B84:001 \(P704.01\)](#) for the hold time set in [0x2B84:002 \(P704.02\)](#).
- The exact behaviour depends on the stop method set in [0x2838:003 \(P203.03\)](#).

Stop method = "Standard ramp [1]"

Parameter	Designation	Setting for this example
0x2631:001 (P400.01)	Enable inverter	Digital input 1 [11]
0x2631:002 (P400.02)	Run	Digital input 2 [12]
0x2631:004 (P400.04)	Reset fault	Not connected [0]
0x2838:003 (P203.03)	Stop method	Standard ramp [1]
0x2860:001 (P201.01)	Frequency control: Default setpoint source	Frequency preset 1 [11]
0x2911:001 (P450.01)	Frequency setpoint presets: Preset 1	40 Hz
0x2B84:001 (P704.01)	Current	50 %
0x2B84:002 (P704.02)	Automatic hold time	10 s
0x2B84:003 (P704.03)	Automatic operating threshold	15 Hz

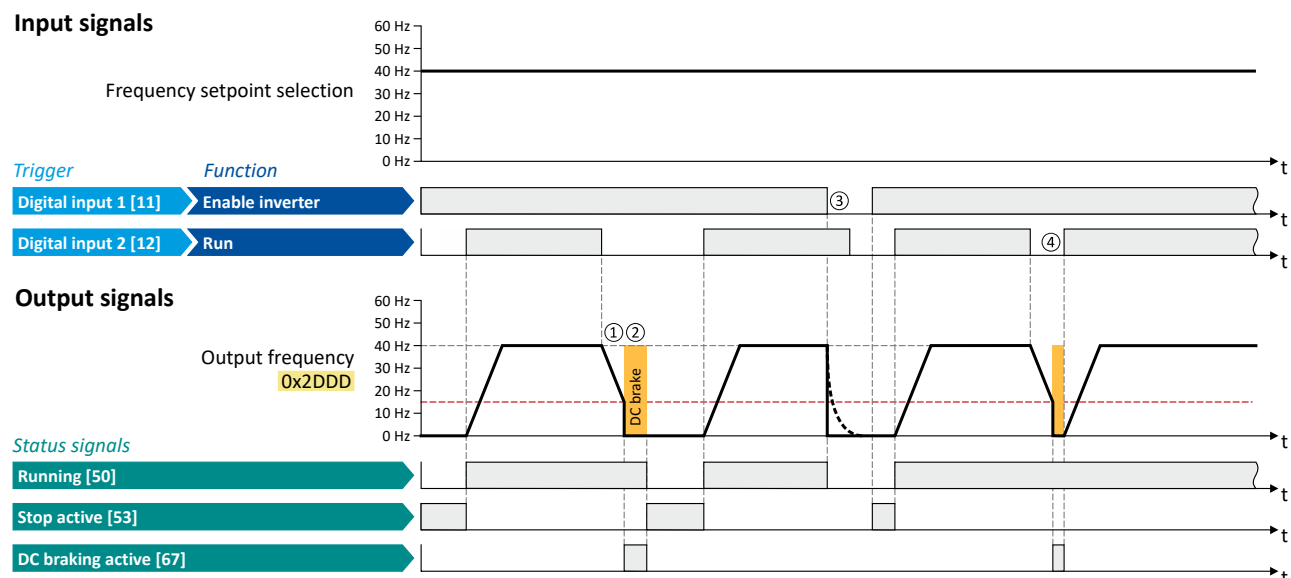

The status signals can be assigned to digital outputs. ▶ [Configure digital outputs](#) 247

- ① With the stop method "Standard ramp [1]", the motor is first decelerated normally until the value falls below the operating threshold set in [0x2B84:003 \(P704.03\)](#).
- ② The DC braking becomes active for the hold time set in [0x2B84:002 \(P704.02\)](#).
- ③ If the inverter is disabled, the motor coasts. (DC braking is only possible if the inverter is enabled.)
- ④ If there is a new start command within the hold time, the DC braking is cancelled. The motor is accelerated to the setpoint again.

Stop method = "Quick stop ramp [2]"

Same behaviour as with the stop method "Standard ramp [1]", except that the motor is decelerated with the quick stop ramp instead of the standard ramp.



Stop method = "Coasting [0]"

Parameter	Designation	Setting for this example
0x2631:001 (P400.01)	Enable inverter	Digital input 1 [11]
0x2631:002 (P400.02)	Run	Digital input 2 [12]
0x2838:003 (P203.03)	Stop method	Coasting [0]
0x2860:001 (P201.01)	Frequency control: Default setpoint source	Frequency preset 1 [11]
0x2911:001 (P450.01)	Frequency setpoint presets: Preset 1	40 Hz
0x2B84:001 (P704.01)	Current	50 %
0x2B84:002 (P704.02)	Automatic hold time	10 s
0x2B84:003 (P704.03)	Automatic operating threshold	15 Hz

Input signals

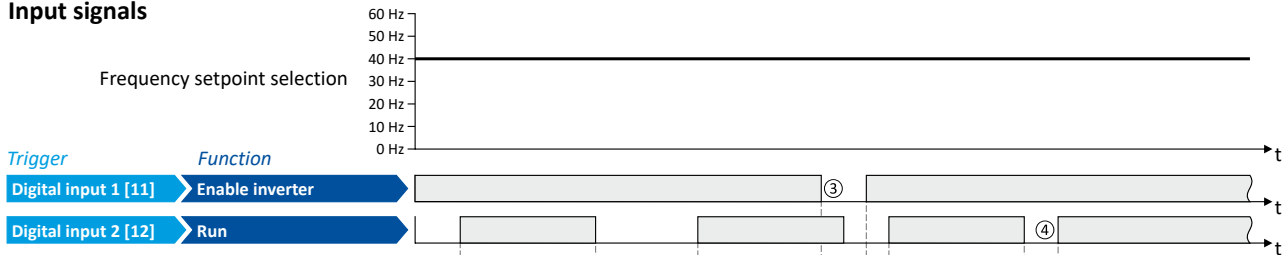

Output signals

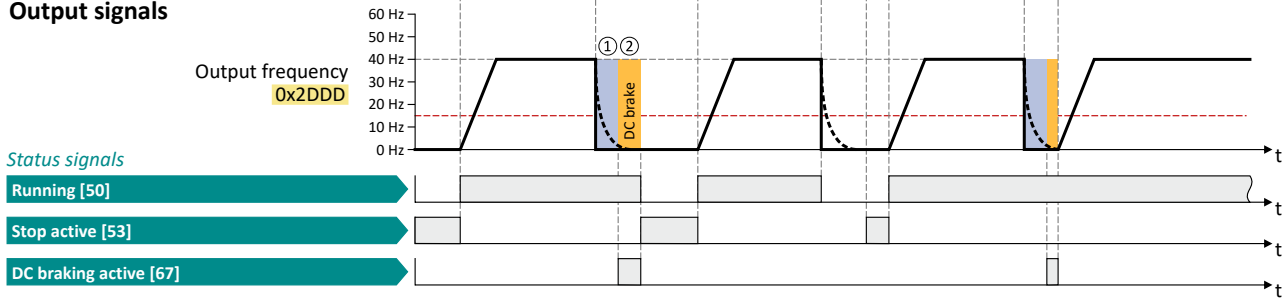

The status signals can be assigned to digital outputs. [▶ Configure digital outputs](#) 247

- ① With the stop method "Coasting [0]", the motor first coasts down for a specified time. This "demagnetising time" serves to reduce the induced voltage.
- ② The DC braking becomes active for the hold time set in [0x2B84:002 \(P704.02\)](#).
- ③ If the inverter is disabled, the motor coasts. (DC braking is only possible if the inverter is enabled.)
- ④ If there is a new start command within the hold time, the DC braking is cancelled. The motor is accelerated to the setpoint again.

Configuring the motor control

Parameterisable motor functions
DC braking



10.5.2.3 Activating DC braking manually

By means of the "Activate DC braking" function, DC braking can be activated manually.

Preconditions

The current for DC braking must be set > 0 % so that the function can be executed.

Parameter

Address	Name / setting range / [default setting]	Information
0x2631:005 (P400.05)	Function list: Activate DC braking (Function list: DC braking) • Further possible settings: ▶ Trigger list 59	Assignment of a trigger for the "Activate DC braking" function. Trigger = TRUE: Activate DC braking. Trigger = FALSE: Deactivate DC braking. ⚠ CAUTION! DC braking remains active as long as the trigger is set to TRUE. ▶ DC braking 190
	0 Not connected	No trigger assigned (trigger is constantly FALSE).

Example for operating mode

- Switch S1 starts the motor in forward direction of rotation. De-asserting switch S1 stops the motor again.
- Switch S2 activates DC braking.

Connection plan	Function
	Potentiometer R1: Frequency setpoint selection
	Switch S1: Run
	Switch S2: Activate DC braking

Parameter	Designation	Setting for this example
0x2631:001 (P400.01)	Enable inverter	Constant TRUE [1]
0x2631:002 (P400.02)	Run	Digital input 1 [11]
0x2631:004 (P400.04)	Reset fault	Not connected [0]
0x2631:005 (P400.05)	Activate DC braking	Digital input 2 [12]
0x2824 (P200.00)	Control selection	Flexible I/O configuration [0]
0x2838:003 (P203.03)	Stop method	Standard ramp [1]
0x2860:001 (P201.01)	Frequency control: Default setpoint source	Analog input 1 [2]
0x2B84:001 (P704.01)	DC braking: Current	10 %



Configuring the motor control

Parameterisable motor functions
DC braking

Input signals

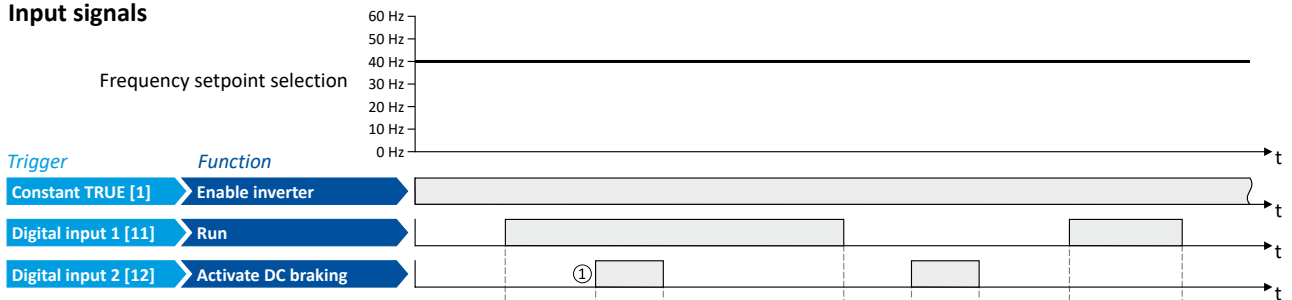

Output signals

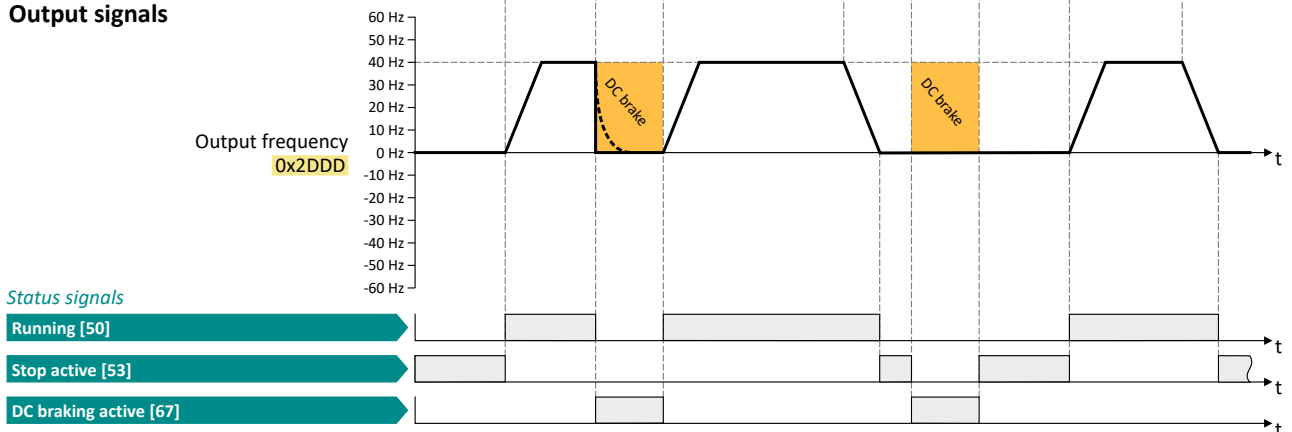

The status signals can be assigned to digital outputs. ▶ [Configure digital outputs](#) 247

- ① If DC braking is activated while the motor is running, the output pulses of the inverter are disabled immediately. For stopping the motor, the current set in 0x2B84:001 (P704.01) is injected. The exact drive behaviour depends on the settings for the "DC braking" function and the load properties.

Configuring the motor control

Parameterisable motor functions
DC braking



10.5.2.4 Migration of Lenze Inverter Drives 8200/8400

The behaviour of the Lenze Inverter Drives 8200/8400 in case of automatic DC braking is different: In case of these inverters, after the auto DCB hold time has elapsed, the motor is deenergised (by means of pulse inhibit) until the setpoint exceeds the auto DCB operating threshold. In order to make a migration to the i500 inverter series easier, the setting `0x2B84:006 (P704.06) = "1"` serves to activate the same behaviour in the i500.

The following example illustrates the behaviour of the function if `0x2B84:006 (P704.06) = "1"`.

Parameter	Designation	Setting for this example
<code>0x2631:001 (P400.01)</code>	Enable inverter	Constant TRUE [1]
<code>0x2631:002 (P400.02)</code>	Run	Digital input 1 [11]
<code>0x2631:013 (P400.13)</code>	Reverse rotational direction	Digital input 3 [13]
<code>0x2838:003 (P203.03)</code>	Stop method	Standard ramp [1]
<code>0x2B84:001 (P704.01)</code>	Current	50 %
<code>0x2B84:002 (P704.02)</code>	Automatic hold time	10 s
<code>0x2B84:003 (P704.03)</code>	Automatic operating threshold	10 Hz
<code>0x2B84:006 (P704.06)</code>	Inverter disable	1

Input signals

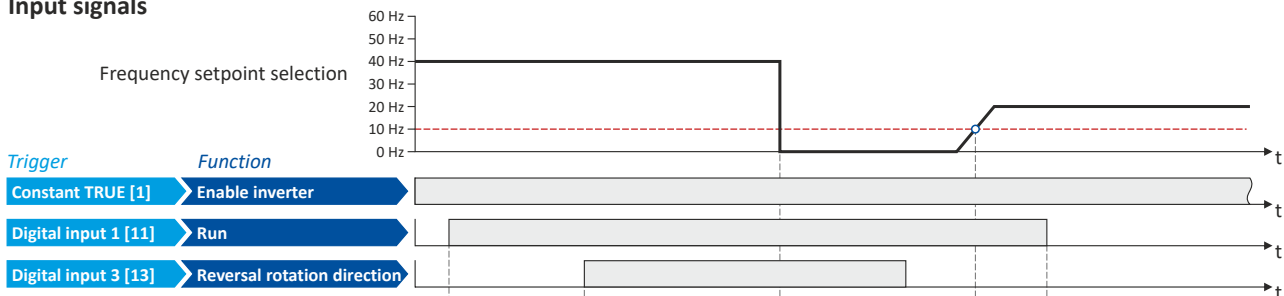

Output signals

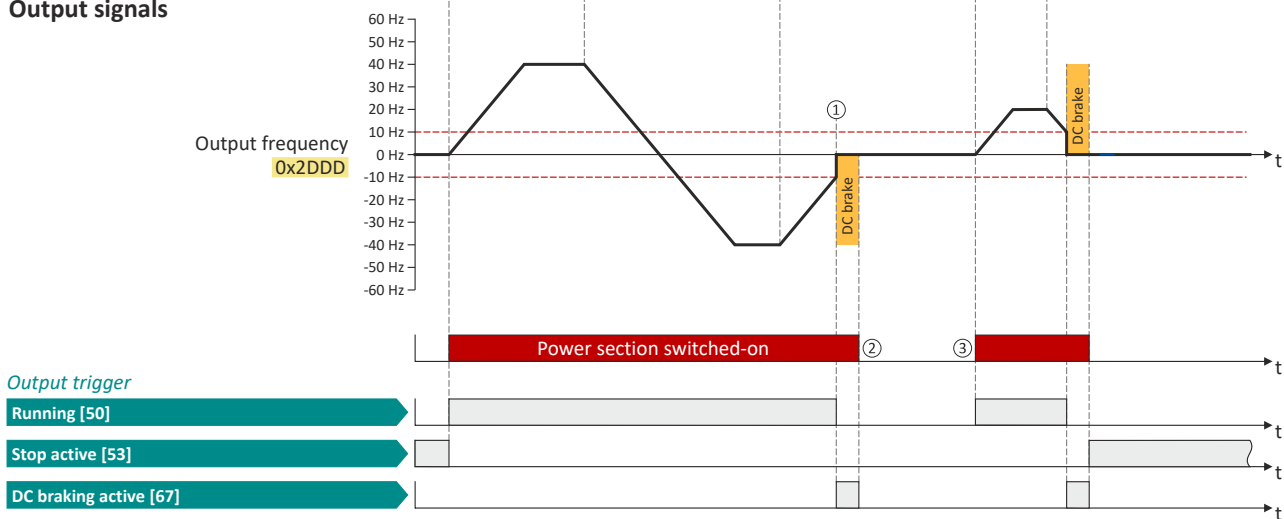

The status signals can be assigned to digital outputs. ▶ [Configure digital outputs](#) 247



- ① If the setpoint falls below the operating threshold set in `0x2B84:003 (P704.03)`, the DC braking gets active for the hold time set in `0x2B84:002 (P704.02)`.
- ② After the hold time has elapsed, the power section is switched off.
- ③ If the setpoint exceeds the operating threshold again, the power section is switched on again. The motor is accelerated to the setpoint again.



10.5.3 Holding brake control

This function serves as a low-wear control of a holding brake. The holding is usually mounted to the motor as an option. The holding brake can be automatically released via the start command for the inverter or manually via an external control signal, for instance, by a higher-level Controller. The interaction of higher-level Controller and holding brake is especially important for vertical applications. Horizontal applications need a less demanding holding brake control.

Preconditions

- Observe that the holding brake is an important element of the machine's safety concept as a whole. Therefore be sure to carry out commissioning of this system part with particular care!
- Holding brakes are not intended for braking during operation. The increased wear caused by braking during operation may destroy the holding brake prematurely!
- **Automatic DC braking must be deactivated if a holding brake is used.**
- The holding brake control itself only outputs a digital trigger for releasing the holding brake. This trigger "Release holding brake [115]" must be assigned to a digital output or, in the simplest case, to the relay when then switches the brake supply. ▶ [Configure digital outputs](#)  247
- If the holding brake is to be controlled via a digital output, the use of an additional relay or power contactor is required. The digital output is not suited for direct control of a holding brake.
- If, instead of an electrically releasing (self-holding) holding brake, an electrically holding (self-releasing) holding brake is to be controlled, a signal inversion for the digital output used or for the relay must be set! ▶ [Configure digital outputs](#)  247

Configuring the motor control

Parameterisable motor functions
Holding brake control



10.5.3.1 Basic setting

The following parameters must be set for the activation and basic configuration of the holding brake control.



When a power contactor is used, the response time and release time of the contactor are added to the brake application and release time. Both times must also be taken into consideration for parameterising the brake application time and brake opening time!



Deactivate automatic DC braking, if a holding brake is used.

Parameter

Address	Name / setting range / [default setting]	Information
0x2820:001 (P712.01)	Holding brake control: Brake mode (Brake control: Brake mode)	Selecting how the "Release holding brake" command is to be triggered.
	0 Automatically (via device state)	"Automatic operation": The "Release holding brake" command is automatically carried out as a function of the device state and further conditions. ⚠ CAUTION! In automatic operation, a manual release of the holding brake is also possible! For details see the following information for selection "Manually [1]".
	1 Manually	The "Release holding brake" command can also be initiated by the following external triggers: <ul style="list-style-type: none"> Via the trigger assigned to the "Release holding brake" function in 0x2631:049 (P400.49) if the network control is not active. Via bit 14 in the CiA control word 0x6040 if the network control is active. ⚠ CAUTION! <ul style="list-style-type: none"> The manually triggered "Release holding brake" command has a direct impact on the "Release holding brake [115]" trigger. Thus, the holding brake can be manually released if the power section is switched off! The ramp function generator only starts up when the brake is released in the case of manual control. The responsibility for a manual release of the holding brake has the external trigger source for the "Release holding brake" command!
	2 Off	The holding brake is deactivated.
0x2820:002 (P712.02)	Holding brake control: Brake closing time (Brake control: Closing time) 0 ... [100] ... 10000 ms	Application time (engagement time) of the holding brake. <ul style="list-style-type: none"> Only effective in automatic operation.
0x2820:003 (P712.03)	Holding brake control: Brake opening time (Brake control: Opening time) 0 ... [100] ... 10000 ms	Release time (disengagement time) of the holding brake. <ul style="list-style-type: none"> Only effective in automatic operation.
0x2820:015 (P712.15)	Holding brake control: Brake status (Brake control: Brake status) <ul style="list-style-type: none"> Read only 	Display of the holding brake status. <ul style="list-style-type: none"> The status is also displayed via bit 14 in the CiA status word 0x6041 (P780.00).
	0 Active	Holding brake is applied.
	1 Brake released	Holding brake is released.

For examples and details on more possible settings, see the following subchapter:

- ["Automatic" brake mode \(automatic operation\)](#) 199
- [Brake holding load](#) 200
- [Brake closing threshold](#) 202
- [Manual release of the holding brake](#) 204



10.5.3.2 "Automatic" brake mode (automatic operation)

In automatic operation, the inverter automatically released the holding brake when the motor is started. In the stopped state, the holding brake is closed.

⚠ DANGER!

Manual release of the holding brake

In automatic operation, a manual release of the holding brake is also possible. The manually triggered "Release holding brake" command has a direct impact on the "Release holding brake [115]" trigger. Thus, the holding brake can be manually released if the power section is switched off.

- ▶ The responsibility for a manual release of the holding brake has the external trigger source for the "Release holding brake" command!

General mode of operation

The following diagram demonstrates the general functional principle of automatic operation:

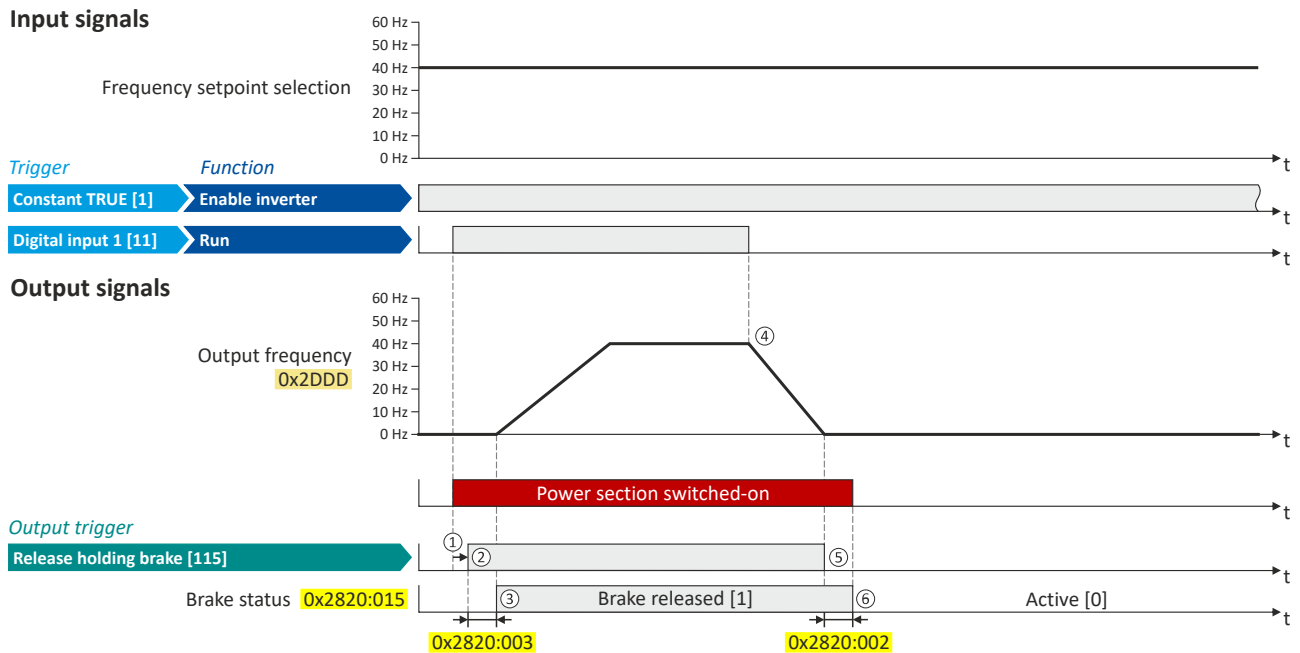

- ① If the inverter is enabled and no error is active, the motor can be started with the "Run" function in forward rotating direction. The power section is switched on and the motor is magnetized first.
- ② The holding brake is released. In this case, the output trigger "Release holding brake [115]" is set to TRUE. This trigger must be assigned to a digital output or, in the simplest case, to the relay which then switches the brake supply.
- ③ After the release time 0x2820:003 (P712.03) has elapsed, the motor is accelerated to the setpoint. In 0x2820:015 (P712.15), the brake status "Brake released [1]" is displayed.
 - If "Run" is set to FALSE, the motor is stopped with the stop method set in 0x2838:003 (P203.03). In the example: Stop with standard ramp.
- ⑤ Then the holding brake is closed again.
- ⑥ After the closing time 0x2820:002 (P712.02) has elapsed, the brake status "Active [0]" is displayed in 0x2820:015 (P712.15).



If the power section is disabled, the holding brake is closed. This may be due to an error.

Configuring the motor control

Parameterisable motor functions
Holding brake control



10.5.3.3 Brake holding load

Depending on the application, a torque at the motor may be required at speed "0" of the motor shaft:

- In order to hold loads in vertical applications and prevent "sagging".
- In order to prevent a position loss in horizontal applications.

For this purpose, a brake holding load can be set. The brake holding load can be optionally generated via a ramp to reduce a vibration stimulation that may be caused by the brake holding load.

Preconditions

Ensure that the inverter builds up a sufficient torque in the motor when releasing and applying the holding, in order to hold the load.

- For this purpose, a V/f voltage boost can be set for the V/f characteristic control. ▶ [Set voltage boost](#) [175](#)
- The parameters for the V/f voltage boost are automatically set when you carry out an automatic identification of the motor.

Details

Relevant parameters:

- [0x2820:008 \(P712.08\)](#): Brake holding load
- [0x2820:013 \(P712.13\)](#): Holding load ramptime

Setting notes:

- In case of applications with constant load, a constant value is suitable for the brake holding load.
- If the load changes, an approximate value for the brake holding load has to be considered.
- Start with the setting "0 %" if you do not know the correct direction, otherwise with, for instance, "30 %". Afterwards change the setting upwards or downwards in 10-% steps.

Parameter

Address	Name / setting range / [default setting]	Information
0x2820:008 (P712.08)	Holding brake control: Brake holding load (Brake control: Holding load) -500.0 ... [0.0] ... 500.0 % <ul style="list-style-type: none">• Setting can only be changed if the inverter is disabled.	By setting a holding load, the load can be held against the force of gravity in case of vertical applications, and a position loss can be prevented in case of horizontal applications. <ul style="list-style-type: none">• The setting of "100 %" approximately corresponds to rated motor torque and slip frequency. Note! The torque for creating the holding load depends on the selected motor control type and its settings. Before using this function, make sure that you have set the motor control type correctly.
0x2820:013 (P712.13)	Holding brake control: Holding load ramptime (Brake control: HoldLoad ramptim) 0 ... [0] ... 100 ms <ul style="list-style-type: none">• Setting can only be changed if the inverter is disabled.• From version 03.00	By setting a ramp time, a vibration stimulation can be reduced that might be caused by the brake holding load 0x2820:008 (P712.08) .



Configuring the motor control

Parameterisable motor functions
Holding brake control

General mode of operation

The following diagram demonstrates the general functioning in automatic operation:

Input signals

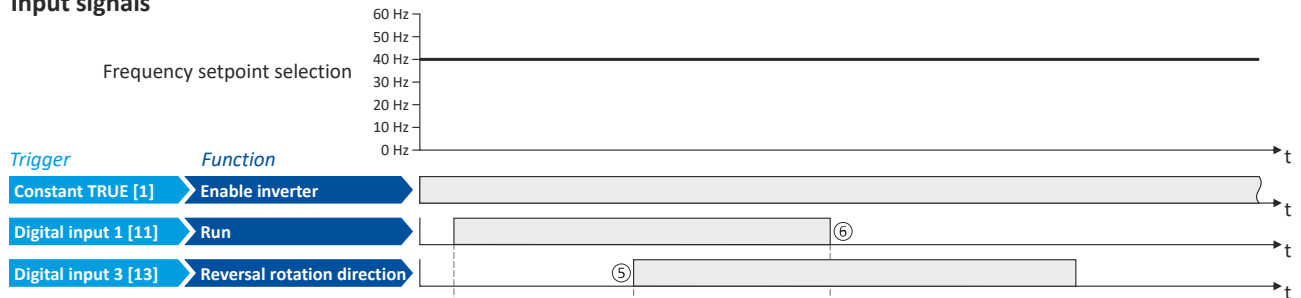

Output signals

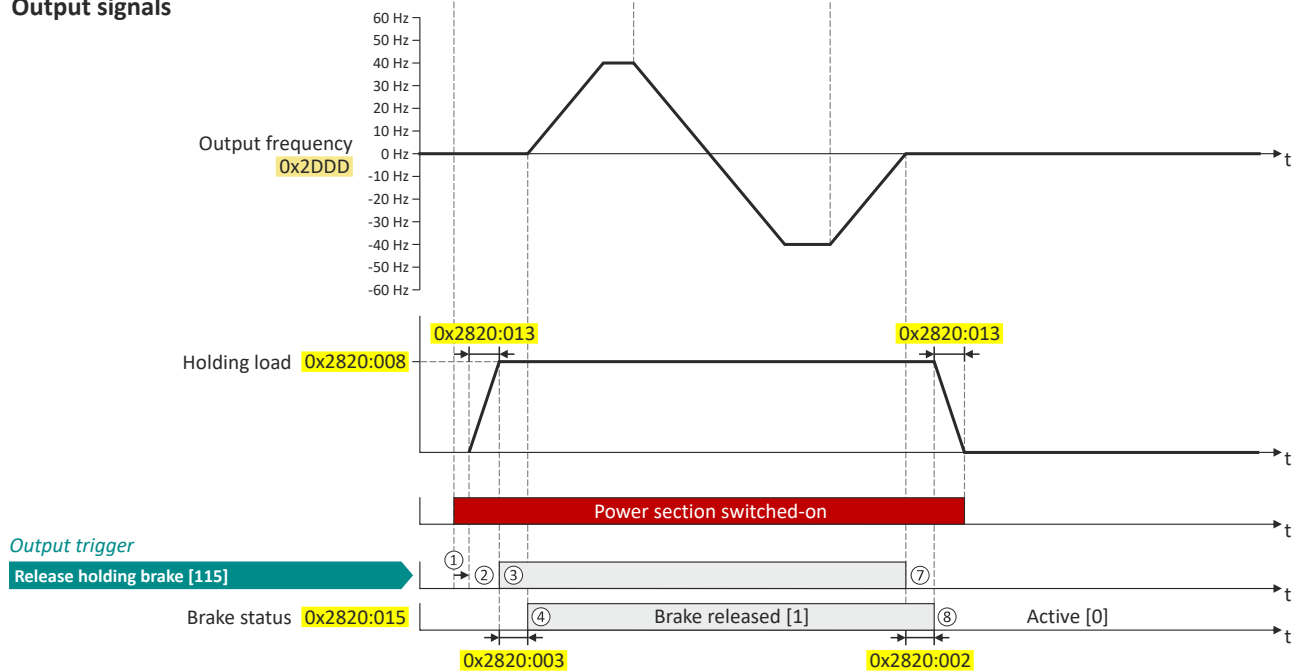

- ① If the inverter is enabled and no error is active, the motor can be started with the "Run" function in forward rotating direction. The power section is switched on and the motor is magnetised first.
- ② The brake holding load set in `0x2820:008` (P712.08) is build up via the ramp set in `0x2820:013` (P712.13).
- ③ The holding brake is released. For this purpose, the output trigger "Release holding brake [115]" is set to TRUE. This trigger must be assigned to a digital output or, in the simplest case, to the relay which then switches the brake supply.
- ④ After the release time `0x2820:003` (P712.03) has elapsed, the motor is accelerated to the setpoint. The brake status "Brake released [1]" is displayed in `0x2820:015` (P712.15).
- ⑤ In case the direction of rotation reverses, the holding brake remains released.
- ⑥ If "Run" is set to FALSE, the motor is stopped with the stop method set in `0x2838:003` (P203.03). In the example: Stop with standard ramp.
- ⑦ Then the holding brake is closed again.
- ⑧ After the closing time `0x2820:002` (P712.02) has elapsed, the brake status "Active [0]" is displayed in `0x2820:015` (P712.15). The brake holding load is reduced again via the ramp.

Configuring the motor control

Parameterisable motor functions
Holding brake control



10.5.3.4 Brake closing threshold

In some cases, a low speed does not make any sense from the application point of view. This includes applications with unfavorable load features, such as static friction. In such applications and depending on the type of control, a low speed may cause an unwanted behaviour. In order to prevent such an operating situation, a closing threshold can be set. The power section will only be switched on and the holding brake is opened if the setpoint is higher than the closing threshold. In order to prevent the holding brake from being closed if the setpoint only shortly falls below the closing threshold during operation, a delay time can be set in addition.

Preconditions

If the holding brake is controlled manually via an external control signal: It must be ensured that the motor does not move while the motor control is deactivated by this function.

Details

The function is part of the holding brake control and does not have independent functionality.

Relevant parameters:

- [0x2820:007 \(P712.07\)](#): Brake closing threshold
- [0x2820:012 \(P712.12\)](#): Closing threshold delay

Setting notes:

- The function is active if the brake closing threshold is higher than 0 Hz.
- In order that the brake can work correctly, the brake closing threshold must be set to a value that is greater than or equals the minimum frequency [0x2915 \(P210.00\)](#).
- The brake closing threshold has a permanent hysteresis of 1 Hz in order to prevent an unwanted change-over. Exception: If the brake closing threshold is set to 0 Hz, the hysteresis is also 0 Hz.
- If the brake closing threshold is set to 0 Hz, a start command is only required to release the holding brake during automatic operation.
- This function can be combined with the setting of a holding load.

Parameter

Address	Name / setting range / [default setting]	Information
0x2820:007 (P712.07)	Holding brake control: Brake closing threshold (Brake control: Closing thresh.) 0.0 ... [0.2] ... 599.0 Hz	Threshold for closing the holding brake. <ul style="list-style-type: none">• The power section will only be switched on and the holding brake will be opened if the setpoint is higher than the threshold set here.• In order that the brake can work correctly, the brake closing threshold must be set to a value that is greater than or equals the minimum frequency 0x2915 (P210.00).• The brake closing threshold has a permanent hysteresis of 1 Hz in order to prevent an unwanted change-over. Exception: If the brake closing threshold is set to 0 Hz, the hysteresis is also 0 Hz.• In case of a setting of "0 Hz", only a start command is required to release the holding break during automatic operation.
0x2820:012 (P712.12)	Holding brake control: Closing threshold delay (Brake control: ClosingThr delay) 0 ... [0] ... 10000 ms <ul style="list-style-type: none">• From version 03.00	By setting a deceleration, a closing of the holding brake can be prevented if the frequency only temporarily falls below the brake closing threshold 0x2820:007 (P712.07) .



Configuring the motor control

Parameterisable motor functions
Holding brake control

General mode of operation

The following diagram demonstrates the general functioning in automatic operation:

Input signals

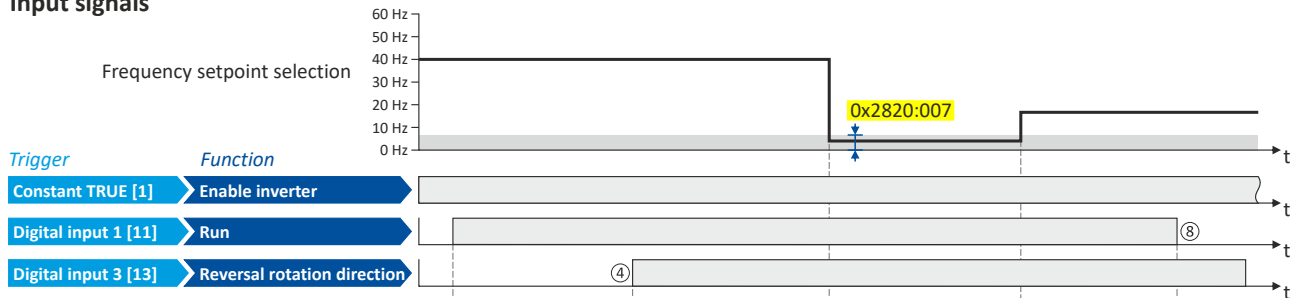

Output signals

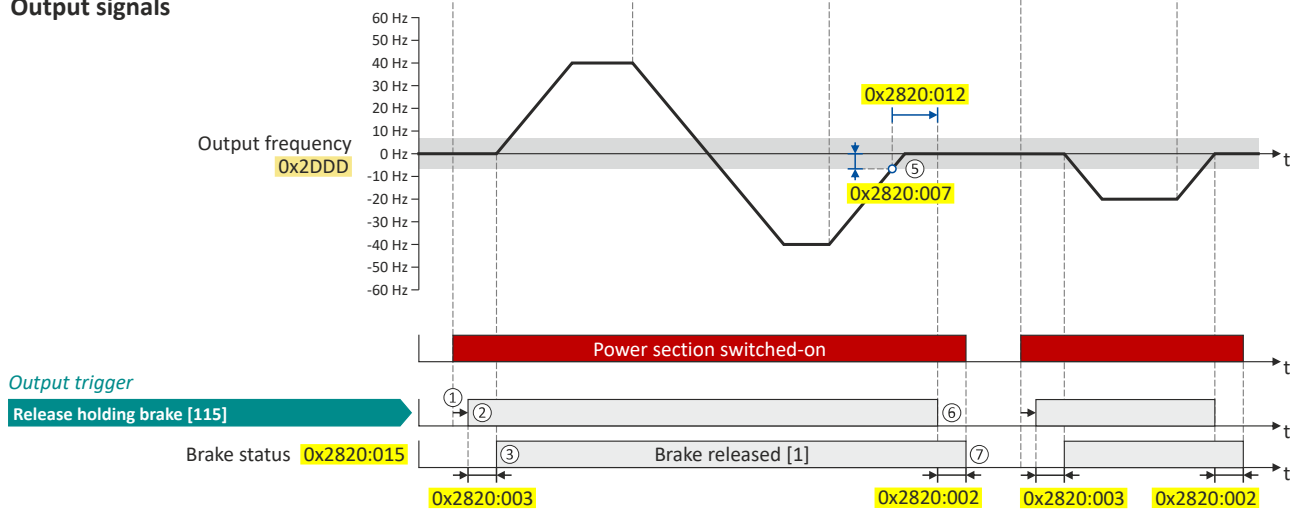

- ① If the inverter is enabled and no error is active, the motor can be started with the "Run" function in forward rotating direction. The power section is switched on and the motor is magnetised first.
- ② The holding brake is released. For this purpose, the output trigger "Release holding brake [115]" is set to TRUE. This trigger must be assigned to a digital output or, in the simplest case, to the relay which then switches the brake supply.
- ③ After the release time `0x2820:003` (P712.03) has elapsed, the motor is accelerated to the setpoint. The brake status "Brake released [1]" is displayed in `0x2820:015` (P712.15).
- ④ If the direction of rotation reverses, the holding brake remains released (even if the closing threshold delay is running.)
- ⑤ If the setpoint selection and the internal setpoint for the motor control fall below the brake closing threshold set in `0x2820:007` (P712.07), the output frequency is ramped down to "0 Hz". At the same time the closing threshold delay set in `0x2820:012` (P712.12) starts to run
- ⑥ If the values fall below the closing threshold longer than the closing threshold delay, the holding brake is closed again.
- ⑦ After the closing time `0x2820:002` (P712.02) has elapsed, the brake status "Active [0]" is displayed in `0x2820:015` (P712.15).
- ⑧ If "Run" is set to FALSE, the motor is stopped with the stop method set in `0x2838:003` (P203.03). In the example: Stop with standard ramp. In this case, closing threshold and closing threshold delay are not effective anymore.

Configuring the motor control

Parameterisable motor functions
Holding brake control



10.5.3.5 Manual release of the holding brake

The "Open holding brake" function serves to release the holding brake immediately. Brake application time and brake opening time as well as the conditions for the automatic operation are not effective.

Preconditions

- Observe setting and application notes in the "Holding brake control" chapter! [197](#)
- The brake mode "Automatic [0]" or "Manual [1]" must be set in [0x2820:001 \(P712.01\)](#).
- The trigger "Release holding brake [115]" must be assigned to a digital output or, in the simplest case, to the relay which then switches the brake supply.

Details

A manual opening of the holding brake is possible in the modes "Automatic [0]" and "Manual [1]" via the following external triggers:

- Via bit 14 in the CiA control word [0x6040](#).
- Via the trigger in [0x2631:049 \(P400.49\)](#) assigned to the "Open holding brake" function.
 - ▶ [Example for operating mode 204](#)

Parameter

Address	Name / setting range / [default setting]	Information
0x2631:049 (P400.49)	Function list: Open holding brake (Function list: Open brake) <ul style="list-style-type: none"> • Setting can only be changed if the inverter is disabled. • Further possible settings: ▶ Trigger list 59 	Assignment of a trigger for the "Open holding brake" function. Trigger = TRUE: open holding brake (immediately). Trigger = FALSE: no action. Notes: <ul style="list-style-type: none"> • Function is only executed if the brake mode 0x2820:001 (P712.01) is set to "Automatic [0]" or "Manual [1]". ⚠ CAUTION! <ul style="list-style-type: none"> • The manually triggered "Open holding brake" command has a direct impact on the "Release holding brake [115]" trigger. Thus, the holding brake can be manually released if the power section is switched off! • The responsibility for a manual opening of the holding brake lies with the external trigger source for the "Open holding brake" command!
	0 Not connected	No trigger assigned (trigger is constantly FALSE).

Example for operating mode

- Switch S1 starts the motor in forward direction of rotation. De-asserting switch S1 stops the motor again.
- Switch S2 opens the holding brake. For this purpose, in this example, trigger "Release holding brake [115]" is assigned to the relay that switches the brake supply.

Connection plan	Function
	Potentiometer R1: Frequency setpoint selection
	Switch S1: Run
	Switch S2: Open holding brake

Parameter	Designation	Setting for this example
0x2631:001 (P400.01)	Enable inverter	Constant TRUE [1]
0x2631:002 (P400.02)	Run	Digital input 1 [11]
0x2631:004 (P400.04)	Reset fault	Not connected [0]
0x2631:049 (P400.49)	Open holding brake	Digital input 2 [12]
0x2634:001 (P420.01)	Relay	Release holding brake [115]
0x2824 (P200.00)	Control selection	Flexible I/O configuration [0]
0x2838:003 (P203.03)	Stop method	Standard ramp [1]
0x2860:001 (P201.01)	Frequency control: Default setpoint source	Analog input 1 [2]



Configuring the motor control

Parameterisable motor functions
Holding brake control

Input signals

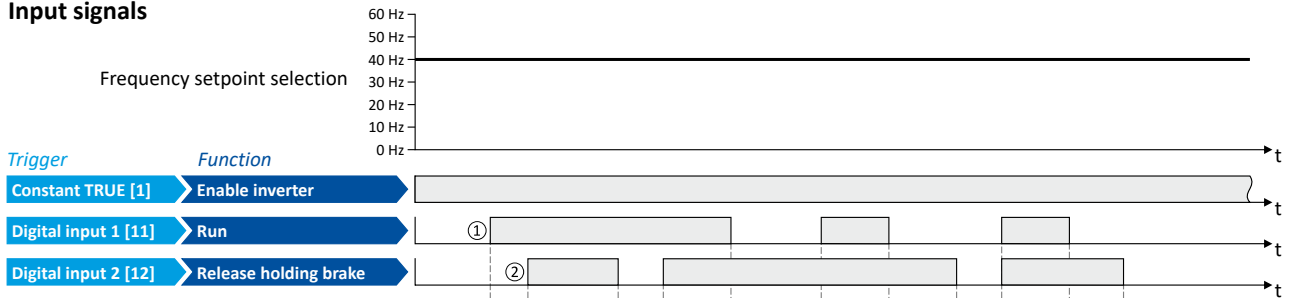

Output signals

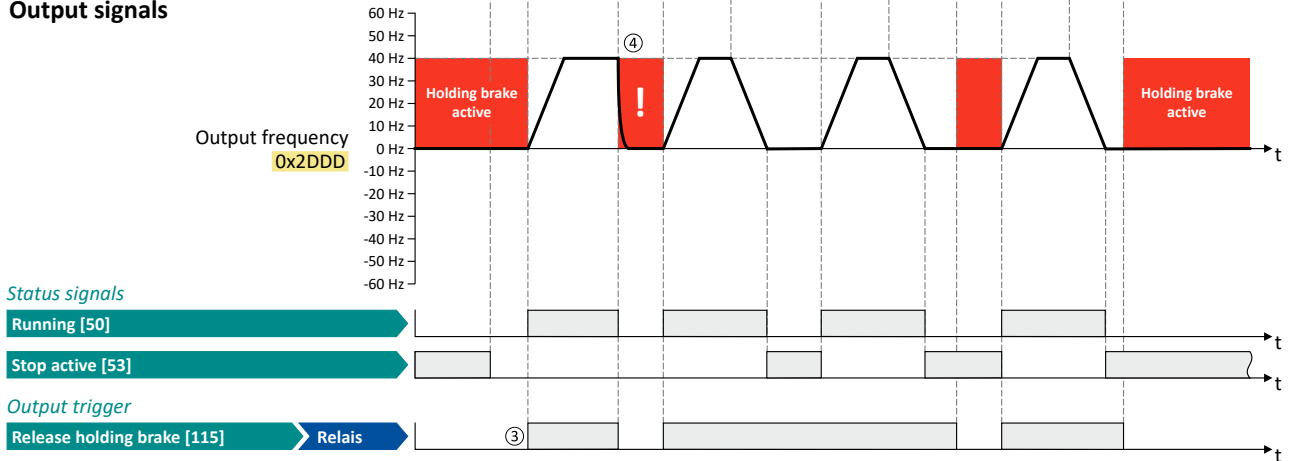

The status signals can be assigned to digital outputs. ▶ [Configure digital outputs](#) 247

- ① As the holding brake is active, the motor does not yet start to rotate after the start command.
- ② The holding brake is opened. The motor is led to the setpoint.
- ③ In this example, the "Release holding brake [115]" trigger is assigned to the relay that switches the brake supply. In the sleep mode, the holding brake is applied. If the relay is energised, the holding brake is opened.
- ④ **Note:** Holding brakes are not intended for braking during operation. The increased wear caused by braking during operation may destroy the holding brakes prematurely!

Configuring the motor control

Parameterisable motor functions
Load loss detection



10.5.4 Load loss detection

This function serves to detect a load loss during operation and to then activate a specific function, for instance the switching of the relay.

Details

If, during operation, the current motor current falls below the threshold set in [0x4006:001 \(P710.01\)](#) for at least the time set in [0x4006:002 \(P710.02\)](#), the internal status signal "Load loss detected [83]" is set to TRUE:

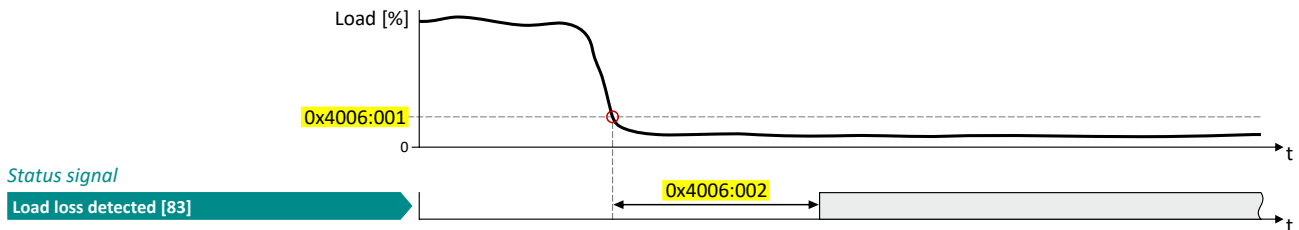

- The threshold is set in percent with reference to the rated motor current "Rated motor current" [0x6075 \(P323.00\)](#).
- The status signal "Load loss detected [83]" can be assigned, for instance, to a digital output or the relay via the flexible I/O configuration. ▶ [Configure digital outputs](#) 247
- An error response can be selected in [0x4006:003 \(P710.03\)](#).
- The load loss detection is not active with active DC braking.





Parameter

Address	Name / setting range / [default setting]	Information
0x4006:001 (P710.01)	Load loss detection: Threshold (Load loss detect: Threshold) 0.0 ... [0.0] ... 200.0 %	Threshold for load loss detection. • 100 % = rated motor current 0x6075 (P323.00)
0x4006:002 (P710.02)	Load loss detection: Delay time (Load loss detect: Delay time) 0.0 ... [0.0] ... 300.0 s	Tripping delay for load loss detection.
0x4006:003 (P710.03)	Load loss detection: Error response (Load loss detect: Error response) • From version 05.01	Selection of the response following the detection of a load loss. Associated error code: • 65336 0xFF38 - Load loss detected
	0 No response	▶ Error types 456
	1 Warning	
	2 Trouble	
	3 Fault	



10.6 Options for optimizing the control loops

Various options are available for optimizing the control:

- a) [Select motor from motor catalog](#)  46
- b) [Automatic motor identification \(energized\)](#)  210
- c) [Automatic motor calibration \(non-energized\)](#)  211
- d) [Tuning of the motor and the speed controller](#)  212

Details

The option to be selected depends on the respective application. Depending on the selected option, different procedures become active and thus different parameter groups are influenced:

- Rated motor data
- Inverter characteristic
- Motor equivalent circuit diagram data
- Motor controller settings
- Speed controller settings

The optimization can be carried out via the keypad or the engineering tools.

Option 1: [Performing optimization with engineering tool](#)  208

Option 2: [Performing optimization with keypad](#)  209

Configuring the motor control

Options for optimizing the control loops



Performing optimization with engineering tool

The following flow diagram shows the optimization process with an engineering tool (e. g. »EASY Starter«):

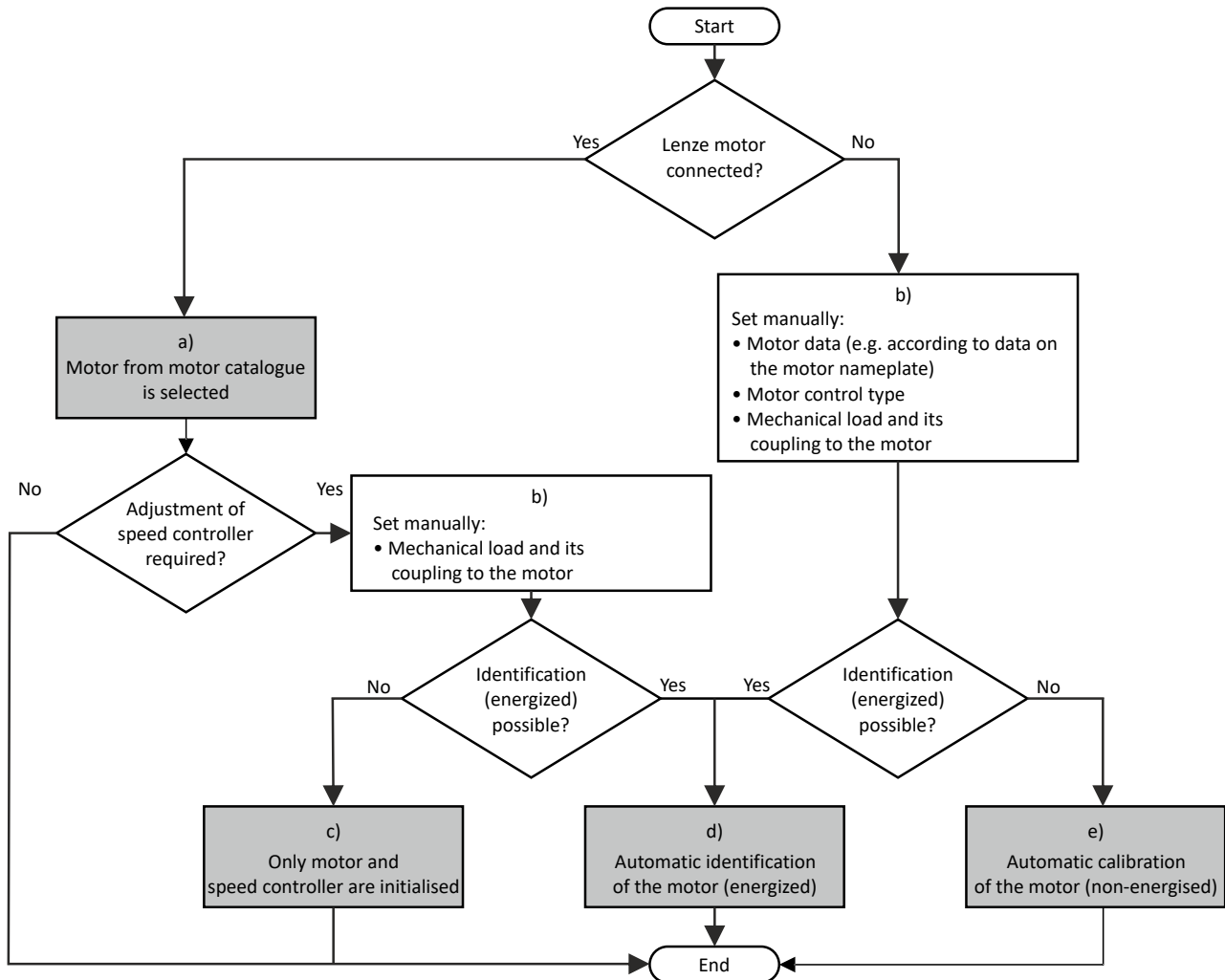

- The relevant motor data must be set first. You benefit from very precise motor equivalent circuit diagram data by selecting the motor from the motor catalogue.
▶ [Select motor from motor catalog](#) 46
- Manually set the motor data in accordance with the manufacturer's information / motor data sheet when a third-party motor is connected to the inverter.
▶ [Manual setting of the motor data](#) 47
- The speed controller must be first reinitialised alone if the load adjustment in the optimized system has changed.
▶ [Tuning of the motor and the speed controller](#) 212
- If the application enables you to energise the system during the optimization procedure, carry out an automatic identification. This procedure results in the best possible parameter settings.
▶ [Automatic motor identification \(energized\)](#) 210
- If the application does **not** enable you to energise the system during the optimization procedure, carry out an automatic calibration.
▶ [Automatic motor calibration \(non-energized\)](#) 211



Performing optimization with keypad

Since there is no access with the keypad to the motor catalogue, first the motor data must be set manually with the keypad according to the manufacturer data/motor data sheet.

▶ [Manual setting of the motor data](#) 47

The following flow diagram shows the optimisation process with the keypad:

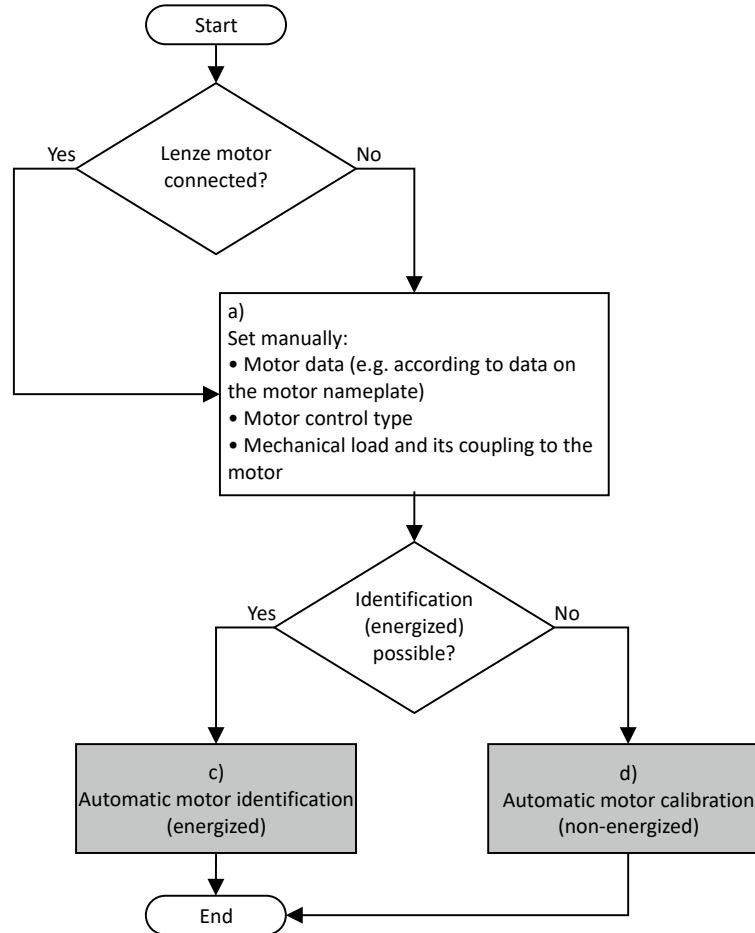

a) Manually set the motor data in accordance with the manufacturer's information / motor data sheet when a third-party motor is connected to the inverter.

▶ [Manual setting of the motor data](#) 47

c) If the application enables you to energise the system during the optimization procedure, carry out an automatic identification. This procedure results in the best possible parameter settings.

▶ [Automatic motor identification \(energized\)](#) 210

d) If the application does not enable you to energise the system during the optimization procedure, carry out an automatic calibration.

▶ [Automatic motor calibration \(non-energized\)](#) 211

Configuring the motor control

Options for optimizing the control loops
Automatic motor identification (energized)



10.6.1 Automatic motor identification (energized)

The automatic identification of the motor results in the best possible parameter settings. If the application enables you to energise the system during the optimization, carry out this optimization.

Conditions



The motor must be cold and at a standstill.

- All rated motor data are known and set in the inverter, either by selecting the motor from the motor catalog or manually:
 - ▶ [Select motor from motor catalog](#) 46
 - ▶ [Manual setting of the motor data](#) 47
- In **0x2C00 (P300.00)**, the motor control type required is suitable for the motor selected.
- In **0x6060 (P301.00)**, the operating mode "MS: Velocity mode [-2]" or "CiA: Velocity mode [2]" is set.
- DC-bus voltage is available.
- The inverter is error-free and in the "Ready to switch on" or "Switched on" device state.
- The motor is stopped (no start enable).
- No inverter disable is active.
- No quick stop is active.
- No other axis command is active.

General information on the identification

- The automatic identification can take from some seconds to minutes.
- The procedure can be aborted any time by inverter disable or cancellation of the start enable without settings being changed.
- During calibration and after the calibration has been completed successfully, the blue LED display is constantly on. As soon as the identification has been executed and the device is deactivated, the LED changes to a blinking mode.
- After completion, a renewed start command is required to start the motor.

Required steps

Optimization with engineering tool (e. g. »EASY Starter«):

1. Go to the "Settings" tab and navigate to the parameterization dialog "Advanced motor setting".
2. Press the **Energized** button under "motor calibration".
3. Follow the instructions of the engineering tool.

Optimization with keypad:

1. Request automatic identification: Set **0x2822:004 (P327.04)** = "1".
2. Issue the start command to start the procedure.
3. The motor calibration is performed.
4. After completion, issue the start command again.

In order to achieve the most optimum behavior for the user, the parameters listed below can be used to influence the motor identification.

Parameter

Address	Name / setting range / [default setting]	Information
0x2822:004 (P327.04)	Identify motor data (energized) (Identify mot.) 0 ... [0] ... 1	1 = start automatic identification of the motor data. <ul style="list-style-type: none">• Inverter characteristics, motor equivalent circuit diagram data and controller settings are identified and set automatically.• During the procedure, the motor is energised!



Configuring the motor control

Options for optimizing the control loops
Automatic motor calibration (non-energized)

Optimization process

As soon as the process has been started, the following steps are initiated:

1. The inverter characteristic is automatically identified by the inverter.
2. The motor equivalent circuit diagram data are automatically identified by the inverter.
3. The motor controller settings are automatically calculated.
4. The speed controller settings are automatically calculated.

10.6.2 Automatic motor calibration (non-energized)

If the application does not enable you to energise the system during the optimization, carry out this optimization.

Preconditions

- All rated motor data is known and set in the inverter, either by selecting the motor from the motor catalogue or manually.
 - ▶ [Select motor from motor catalog](#) 46
 - ▶ [Manual setting of the motor data](#) 47
- In **0x2C00 (P300.00)**, the motor control type required and suitable for the motor is selected.
- The inverter is error-free and in the "Ready to switch on" or "Switched on" device state.
- The inverter is disabled or the motor is stopped (no start enable).
- No other axis command is active anymore.

Required steps

Optimization with engineering tool (e. g. »EASY Starter«):

1. Go to the "Settings" tab and navigate to the parameterisation dialog "Advanced motor setting".
2. Click the **Non-energized** button under "motor calibration".
3. Follow the instructions of the engineering tool.

Optimization with keypad:

- [0x2822:005 \(P327.05\)](#) Set = "1" to start the process.

Parameter

Address	Name / setting range / [default setting]	Information
0x2822:005 (P327.05)	Calibrate motor data (non-energized) (Calibrate mot.) 0 ... [0] ... 1	1 = start automatic calibration of the motor data. <ul style="list-style-type: none">• A default inverter characteristic is loaded.• the motor equivalent circuit diagram data and controller settings are calculated on the basis of the currently set rated motor data.• The motor is not energised.

Optimization process

As soon as the process has been started, the following steps are initiated:

1. A default inverter characteristic is loaded.
2. The motor equivalent circuit diagram data is calculated based on the currently set rated motor data.
3. The motor controller settings are automatically calculated.
4. The speed controller settings are automatically calculated.

Configuring the motor control

Options for optimizing the control loops
Tuning of the motor and the speed controller



10.6.3 Tuning of the motor and the speed controller

The following describes in general how to optimize the speed controller. This may be required if some parameters on the load side of the drive system have changed or have not been set yet, such as:

- Motor moment of inertia
- Load moment of inertia
- Type of coupling between motor moment of inertia and load moment of inertia

Preconditions

- All rated motor data is known and set in the inverter, either by selecting the motor from the motor catalog or manually.
 - ▶ [Select motor from motor catalog](#) 46
 - ▶ [Manual setting of the motor data](#) 47
- All further options for optimization have been executed before if possible.
 - ▶ [Automatic motor identification \(energized\)](#) 210
 - ▶ [Automatic motor calibration \(non-energized\)](#) 211
- Optimization is possible online or offline (with or without connected motor).



Configuring the motor control

Options for optimizing the control loops
Tuning of the motor and the speed controller

Required steps

Adapt the following parameters to your drive system using the engineering tool. Since this only changes load-dependent data, the other parameter groups do not need to be calculated again.

In the engineering tool, the speed controller settings can be confirmed via the **Initialise** button.



This function is not available via the keypad.

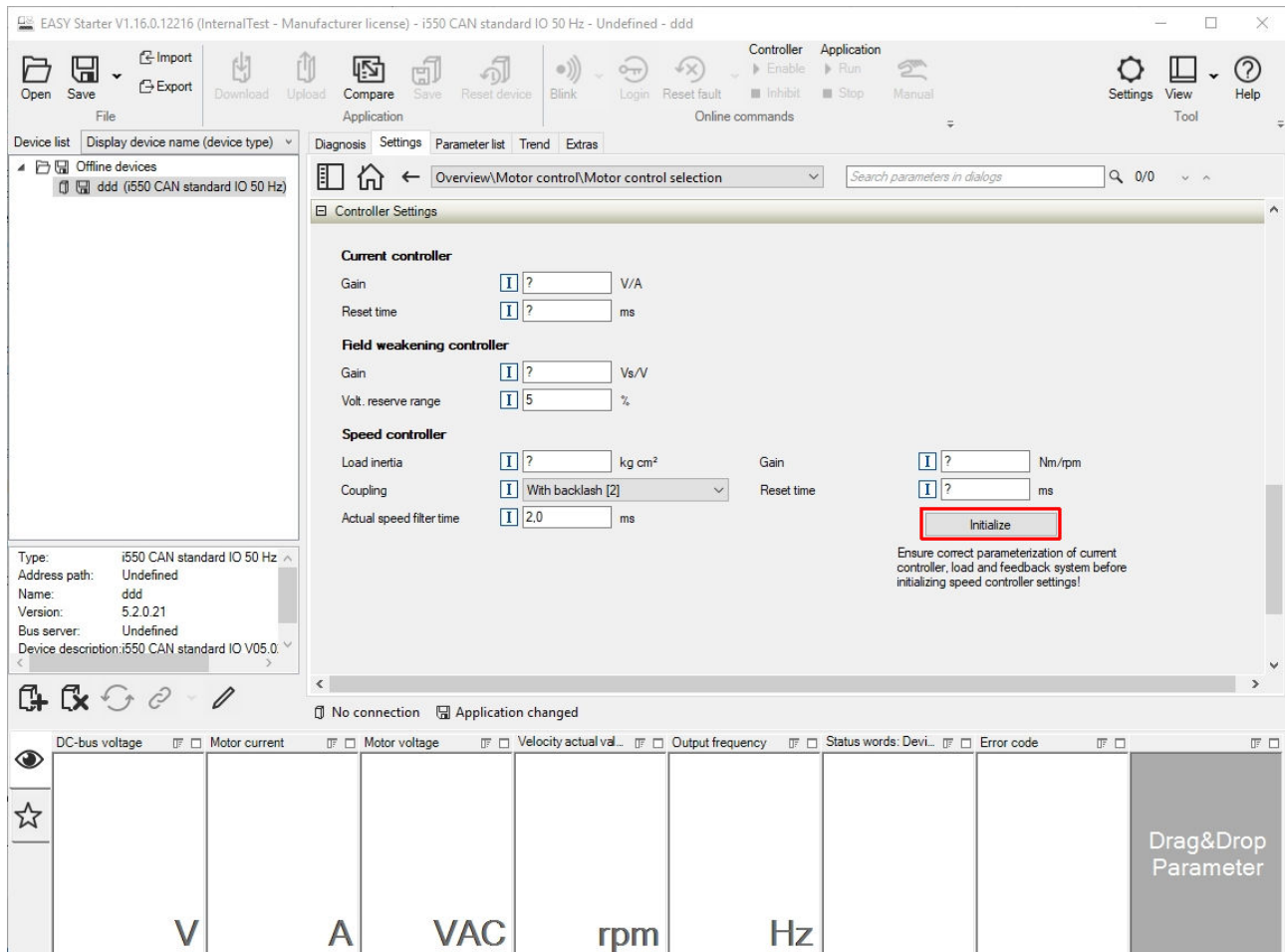

Parameter

Address	Name / setting range / [default setting]	Information
0x2910:001 (P335.01)	Inertia settings: Motor moment of inertia (Moment of inert.: Motor inertia) 0.00 ... [3.70]* ... 20000000.00 kg cm ² * Default setting dependent on the model.	Setting of the moment of inertia of the motor, relating to the motor.
0x2910:002 (P335.02)	Inertia settings: Scaled load inertia (Moment of inert.: Scal load inert.) 0.00 ... [0.00] ... 20000000.00 kg cm ²	Setting of the moment of inertia of the load. <ul style="list-style-type: none"> Always adjust the setting to the current load, otherwise the optimisation process for the speed controller cannot be executed successfully.
0x2910:003	Inertia settings: Coupling	Selection of the type of coupling between the moment of inertia of the motor and that of the load.
	0 Stiff	
	1 Elastic	
	2 With backlash	

For further details on the speed controller, see chapter "[Speed controller](#)". [217](#)

Configuring the motor control

Options for optimizing the control loops
Inverter characteristic



10.6.4 Inverter characteristic

The inverter characteristic is automatically set if one of the following optimizations is carried out:

- ▶ [Automatic motor identification \(energized\)](#) 210
- ▶ [Automatic motor calibration \(non-energized\)](#) 211



The settings made can be seen if required, but should not be changed. A wrong setting may influence the control negatively!

Parameter

Address	Name / setting range / [default setting]	Information
0x2947:001 ... 0x2947:017	Inverter characteristic: Value y1 ... Value y17 0.00 ... [0.00] * ... 20.00 V * Default setting dependent on the model.	The inverter characteristic (consisting of 17 values) is calculated and set during the automatic identification of the motor data. If only an automatic calibration of the motor data is carried out, a default inverter characteristic is loaded instead. Note! Changing these values is not recommended by the manufacturer.

10.6.5 Motor equivalent circuit diagram data

The motor equivalent circuit diagram data are automatically set if one of the following optimizations is carried out:

- ▶ [Select motor from motor catalog](#) 46
- ▶ [Automatic motor identification \(energized\)](#) 210
- ▶ [Automatic motor calibration \(non-energized\)](#) 211

If you use a motor of a different manufacturer, you must adapt the data, e. g. from the motor data sheet according to the sizes and units mentioned if required.

Parameter

Address	Name / setting range / [default setting]	Information
0x2C01:002	Motor parameters: Stator resistance 0.0000 ... [10.1565] * ... 125.0000 Ω * Default setting dependent on the model.	General motor data. Carry out settings as specified by manufacturer data/motor data sheet. Note! When you enter the motor nameplate data, take into account the phase connection implemented for the motor (star or delta connection). Only enter the data applying to the connection type selected.
0x2C01:003	Motor parameters: Stator leakage inductance 0.000 ... [23.566] * ... 500.000 mH * Default setting dependent on the model.	
0x2C02:001 (P351.01)	Motor parameter (ASM): Rotor resistance (ASM motor par.: Rotor resistance) 0.0000 ... [8.8944] * ... 200.0000 Ω * Default setting dependent on the model.	Equivalent circuit data required for the motor model of the asynchronous machine.
0x2C02:002 (P351.02)	Motor parameter (ASM): Mutual inductance (ASM motor par.: Mutual induct.) 0.0 ... [381.9] * ... 50000.0 mH * Default setting dependent on the model.	
0x2C02:003 (P351.03)	Motor parameter (ASM): Magnetising current (ASM motor par.: Magn. current) 0.00 ... [0.96] * ... 500.00 A * Default setting dependent on the model.	
0x2C03:001 (P352.01)	Motor parameter (PSM): Back EMF constant (PSM motor par.: BEMF constant) 0.0 ... [41.8] ... 100000.0 V/1000rpm • From version 02.00	Voltage induced by the motor (rotor voltage / 1000 rpm). For permanently excited synchronous motors, the e.m.f. constant induced in idle state by the motor (reference: 1000 rpm, 20 °C). Measured: Line to Line (L - L)



Configuring the motor control

Options for optimizing the control loops
Motor equivalent circuit diagram data

Address	Name / setting range / [default setting]	Information
0x2C03:005 (P352.05)	Motor parameter (PSM): D-axis inductance Ld (PSM motor par.: D-axis Ld) 0.000 ... [20.000]* ... 500.000 mH * Default setting dependent on the model. • From version 05.03	Parameter not available in this device.
0x2C03:006 (P352.06)	Motor parameter (PSM): Q-axis inductance Lq (PSM motor par.: Q-axis Lq) 0.000 ... [20.000]* ... 500.000 mH * Default setting dependent on the model. • From version 05.03	

Configuring the motor control

Options for optimizing the control loops
Motor control settings



10.6.6 Motor control settings

After the motor settings have been made, the different control loops must be set. For a quick commissioning, the calculations and settings are made automatically if one of the following optimizations is carried out:

- ▶ [Select motor from motor catalog](#) 46
- ▶ [Automatic motor identification \(energized\)](#) 210
- ▶ [Automatic motor calibration \(non-energized\)](#) 211

Details

The following controllers have an influence in the respective motor control type:

Controller	Motor control type			
	VFC open loop	SL-PSM	SLSM-PSM	SLVC
Speed controller 217		●		●
Current controller 218	●	●		●
ASM field controller 219				●
ASM field weakening controller 220				●
Imax controller 221	●			
Flying restart controller 222	●	●		●
SLVC controller 222				●
Current controller (field-oriented control) 219			●	

VFC open loop = V/f characteristic control
SL-PSM/SLSM-PSM = sensorless control for synchronous motor
SLVC = sensorless vector control



10.6.6.1 Speed controller

For a quick commissioning, the calculations and settings are made automatically during the optimization.



For typical applications, a manual adaptation of the parameters of the speed controller is not recommended. A wrong setting may have a negative effect on the control. For special applications, contact the manufacturer before adapting the parameters.

The automatically calculated settings for the speed controller enable an optimal control behaviour for typical load requirements. The oscillographed actual speed value (red) shows the control mode.

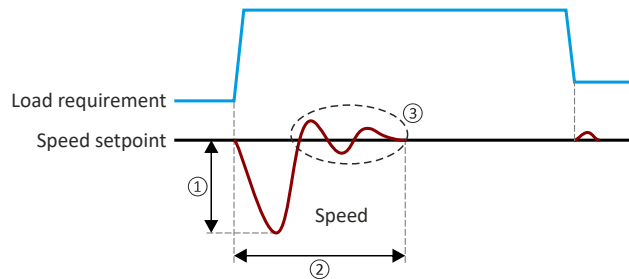

- 1 Minimum speed loss
- 2 Minimum settling time
- 3 Minimum overshoot

Setting notes

If oscillations occur during operation after high loads:

- Reduce gain of the speed controller in [0x2900:001 \(P332.01\)](#).
- Increase reset time of the speed controller in [0x2900:002 \(P332.02\)](#).

If the speed loss is too high or the settling time too long during operation with high loads:

- Increase gain of the speed controller in [0x2900:001 \(P332.01\)](#).



If the gain is set too high or the reset time too low, the speed control loop can become unstable!

Parameter

Address	Name / setting range / [default setting]	Information
0x2900:001 (P332.01)	Speed controller settings: Gain (Speed controller: Gain) 0.00000 ... [0.00193] * ... 20000.00000 Nm/rpm * Default setting dependent on the model.	Gain factor V_p of the speed controller.
0x2900:002 (P332.02)	Speed controller settings: Reset time (Speed controller: Reset time) 1.0 ... [80.0] * ... 6000.0 ms * Default setting dependent on the model.	Reset time T_i of the speed controller.
0x2904	Actual speed filter time 0.0 ... [2.0] ... 50.0 ms	Time constant for the actual speed value filter.

Configuring the motor control

Options for optimizing the control loops
Motor control settings



10.6.6.2 Current controller

For a quick commissioning, the calculations and settings are made automatically during the motor calibration.



For typical applications, a manual adaptation of the parameters of the current controller is not recommended. A wrong setting may have a negative effect on the control. For special applications, contact the manufacturer before adapting the parameters.

Preconditions

The current controller parameters are calculated based on the stator resistance and leakage inductance. Thus, the following parameters must be set correctly, either via optimization or manually (according to manufacturer-data/motor data sheet):

- **0x2C01:002**: Stator resistance
- **0x2C01:003**: Stator leakage inductance

▶ [Motor equivalent circuit diagram data](#) 214

Parameter

Address	Name / setting range / [default setting]	Information
0x2942:001 (P334.01)	Current controller parameters: Gain (Current contr.: Gain) 0.00 ... [42.55]* ... 750.00 V/A * Default setting dependent on the model.	Gain factor V_p of the current controller.
0x2942:002 (P334.02)	Current controller parameters: Reset time (Current contr.: Reset time) 0.01 ... [4.50]* ... 2000.00 ms * Default setting dependent on the model.	Reset time T_i of the current controller.



10.6.6.3 Current controller (field-oriented control)

For quick commissioning, the calculations and settings are made automatically during the motor calibration.



For typical applications, a manual adaptation of the parameters of the current controller is not recommended. An incorrect setting may have a negative effect on the control. For special applications, contact the manufacturer before adapting the parameters.

Preconditions

The current controller described here is only effective in the following motor control mode:

- Sensorless control for synchronous motors (SLSM-PSM)

The current controller parameters are calculated based on the stator resistance and leakage inductance. Thus, the following parameters must be set correctly, either via optimization or manually (according to manufacturer-data/motor data sheet):

- **0x2C01:002**: Stator resistance
- **0x2C03:005 (P352.05)**: D-axis inductance L_d
- **0x2C03:006 (P352.06)**: Q-axis inductance L_q

► [Motor equivalent circuit diagram data](#) 214

Parameter

Address	Name / setting range / [default setting]	Information
0x2942:004	Current controller parameters: d-axis gain 0.00 ... [26.00] * ... 750.00 V/A * Default setting dependent on the model.	Current controller parameters for "SLSM-PSM" motor control mode. ► Sensorless control for synchronous motor (SLSM-PSM) 185
0x2942:005	Current controller parameters: d-axis reset time 0.01 ... [3.00] * ... 2000.00 ms * Default setting dependent on the model.	
0x2942:006	Current controller parameters: q-axis gain 0.00 ... [26.00] * ... 750.00 V/A * Default setting dependent on the model.	
0x2942:007	Current controller parameters: q-axis reset time 0.01 ... [3.00] * ... 2000.00 ms * Default setting dependent on the model.	

10.6.6.4 ASM field controller

For a quick commissioning, the calculations and settings are made automatically during the motor calibration.

Preconditions

The field controller is only effective in the motor control type "Sensorless vector control (SLVC)".

Parameter

Address	Name / setting range / [default setting]	Information
0x29C0:001	Field controller settings: Gain 0.00 ... [59.68] * ... 50000.00 A/Vs * Default setting dependent on the model.	Gain factor V_p of the field controller.
0x29C0:002	Field controller settings: Reset time 1.0 ... [45.5] * ... 6000.0 ms * Default setting dependent on the model.	Reset time T_n of the field controller.

Configuring the motor control

Options for optimizing the control loops
Motor control settings



10.6.6.5 ASM field weakening controller

For a quick commissioning, the calculations and settings are made automatically during the motor calibration.

Preconditions

The field weakening controller is only effective in the motor control type "Sensorless vector control (SLVC)".

Parameter

Address	Name / setting range / [default setting]	Information
0x29E0:001	Field weakening controller settings: Gain (ASM) 0.000 ... [0.000]* ... 2000000.000 Vs/V * Default setting dependent on the model.	Gain factor V_p of the field weakening controller.
0x29E0:002	Field weakening controller settings: Reset time (ASM) 1.0 ... [1478.3]* ... 240000.0 ms * Default setting dependent on the model.	Reset time T_n of the field weakening controller.
0x29E1	Field weakening controller Field limitation 5.00 ... [100.00] ... 100.00 % • From version 04.00	Field limitation of the field weakening controller.

10.6.6.6 ASM field weakening controller (extended)

For a quick commissioning, the calculations and settings are made automatically during the motor calibration.

Preconditions

The field weakening controller is only effective in the motor control type "Sensorless vector control (SLVC)".

Parameter

Address	Name / setting range / [default setting]	Information
0x29E2	DC-bus filter time 1.0 ... [25.0] ... 1000.0 ms	Filter time for the current DC-bus voltage used for field weakening.
0x29E3	Motor voltage filter time 1.0 ... [25.0] ... 1000.0 ms	Filter time for the current motor voltage used for field weakening.
0x29E4 (P354.00)	Voltage reserve range (Voltage reserve) 0 ... [5] ... 20 %	Voltage reserve at the transition point to the field weakening, with reference to the current value of the DC-bus voltage. Wirkt bei Sensorless control (SL PSM) (0x2C00 (P300.00) = 3) und bei Sensorless vector control (SLVC) (0x2C00 (P300.00) = 4). • 100% = DC-bus voltage 0x2D87 (P105.00)

10.6.6.7 PSM field weakening controller

Parameter

Address	Name / setting range / [default setting]	Information
0x29E0:003	Field weakening controller settings: Reset time (PSM) 1.0 ... [800.0]* ... 240000.0 ms * Default setting dependent on the model. • From version 05.02	In the time configured (default 800 ms), the swivel control rotates the current phasor by 90°. Increasing the time makes the system smoother at the voltage limit. At the same time, it also reduces the dynamics.



10.6.6.8 I_{max} controller

For a quick commissioning, the calculations and settings are made automatically during the motor calibration.



For typical applications, a manual adaptation of the parameters of the I_{max} controller is not recommended. A wrong setting may have a negative effect on the control. For special applications, contact the manufacturer before adapting the parameters.

Preconditions

The I_{max} controller is only effective in the motor control type "V/f characteristic control (VFC open loop)".

Details

The I_{max} controller becomes active in the V/f operation if the actual motor current exceeds the maximum current "Max. current". The I_{max} controller changes the output frequency to counteract the exceedance.

The maximum current "Max. current" is defined in [0x6073 \(P324.00\)](#) in percent with regard to the rated motor current "Rated motor current" [0x6075 \(P323.00\)](#).

If the maximum current is exceeded:

- During operation in motor mode, the I_{max} controller reduces the output frequency.
- During operation in generator mode, the I_{max} controller increases the output frequency.

Setting notes

If oscillations occur at the current limit during operation:

- Reduce gain of the I_{max} controller in [0x2B08:001 \(P333.01\)](#).
- Increase reset time of the I_{max} controller in [0x2B08:002 \(P333.02\)](#).
- Carry out the changes in small steps only (by 2 ... 3 % of the set value) until the oscillations do not exist anymore.

If the I_{max} controller does not respond fast enough after the maximum current has been exceeded:

- Increase gain of the I_{max} controller in [0x2B08:001 \(P333.01\)](#).
- Reduce reset time of the I_{max} controller in [0x2B08:002 \(P333.02\)](#).
- Carry out the changes in small steps only (by 2 ... 3 % of the set value in each case) until the response time is acceptable.

Parameter

Address	Name / setting range / [default setting]	Information
0x2822:019	Calculate I _{max} controller parameter 0 ... [0] ... 1	1 = start automatic calculation of the I _{max} controller parameters. • Gain 0x2B08:001 (P333.01) and reset time 0x2B08:002 (P333.02) of the I _{max} controller are recalculated and set.
0x2B08:001 (P333.01)	V/f I _{max} controller: Gain (V/f I _{max} contr.: Gain) 0.000 ... [0.284]* ... 1000.000 Hz/A * Default setting dependent on the model.	Gain factor V _p of the I _{max} controller.
0x2B08:002 (P333.02)	V/f I _{max} controller: Reset time (V/f I _{max} contr.: Reset time) 1.0 ... [2.3]* ... 2000.0 ms * Default setting dependent on the model.	Reset time T _i of the I _{max} controller.

Configuring the motor control

Options for optimizing the control loops
Motor control settings



10.6.6.9 Flying restart controller

For a quick commissioning, the calculations and settings are made automatically during the motor calibration.

Preconditions

The flying restart controller is only effective in the following motor control types:

- V/f characteristic control (VFC open loop)
- Sensorless control (SL PSM)
- Sensorless vector control (SLVC)

Details

The following parameter is only relevant for the flying restart circuit if an asynchronous motor is controlled. In case of a sensorless control of a synchronous motor (SL-PSM) the parameter has no meaning.

Parameter

Address	Name / setting range / [default setting]	Information
0x2BA1:003 (P718.03)	Flying restart circuit: Restart time (Flying restart: Restart time) 1 ... [5911]* ... 60000 ms * Default setting dependent on the model.	Integration time for controlling the flying restart circuit.

10.6.6.10 SLVC controller

For a quick commissioning, the calculations and settings are made automatically during the motor calibration.

Preconditions

The SLVC controller is only effective in the motor control type "Sensorless vector control (SLVC)".

Parameter

Address	Name / setting range / [default setting]	Information
0x2B40:001	Gain 0.0000 ... [0.2686]* ... 1000.0000 Hz/A * Default setting dependent on the model.	Gain of the SLVC-Q controller.
0x2B40:002	Reset time 1.0 ... [2.3]* ... 2000.0 ms * Default setting dependent on the model.	Reset time of the SLVC-Q controller.

10.6.6.11 General optimizations

Parameter

Address	Name / setting range / [default setting]	Information
0x2DE0:010	Motor control behavior 0 ... [0] ... 65535 • Setting can only be changed if the inverter is disabled. • From version 05.03	Optimization of the behavior of the motor control.
	Bit 0 Slip compensation via equivalent circuit diagram	Bit 0 = 0: calculation via motor data label (standard). Bit 0 = 1: calculation of magnetising current based on equivalent circuit diagram (response <= SW 05.02.00).
	Bit 1 Imax controller without clamp detection	Bit x = 1: Activation of the respective option.
	Bit 2 Motor reference temperatur 20 degree celsius	
	Bit 3 Enhanced SLVC stop behavior	
Bit 4 Earth fault detection disabled (from version 06.02)		



10.7 Motor protection

Many monitoring functions integrated in the inverter can detect errors and thus protect the device or motor from being destroyed or overloaded.

Configuring the motor control

Motor protection

Motor overload monitoring (i^2xt)



10.7.1 Motor overload monitoring (i^2xt)

This function monitors the thermal overload of the motor, taking the motor currents recorded and a mathematical model as a basis.

DANGER!

Fire hazard by overheating of the motor.

Possible consequences: Death or severe injuries

- ▶ To achieve full motor protection, an additional temperature monitoring function with a separate evaluation must be installed.

Details

This function only serves to functionally protect the motor. It is not suitable for safety-relevant protection against energy-induced hazards, since the function is not fail-safe.

- When the thermal motor utilisation calculated reaches the threshold set in [0x2D4B:001 \(P308.01\)](#), the response set in [0x2D4B:003 \(P308.03\)](#) is triggered.
- With the setting [0x2D4B:003 \(P308.03\)](#) = "No response [0]", the monitoring function is deactivated.



For operation that complies with NEC article 430 with motor overload protection, do not modify the default settings [0x2D4B:002 \(P308.02\)](#) and [0x2D4B:003 \(P308.03\)](#)! ([0x2D4B:002 \(P308.02\)](#) = "On [0], [0x2D4B:003 \(P308.03\)](#) = "Error [3]"). With these settings, the calculated thermal motor load is stored internally when the inverter is switched off and reloaded again when switched on. When the monitoring is deactivated with the setting [0x2D4B:003 \(P308.03\)](#) = "No response [0]" or "Warning [1]", the motor overload protection is deactivated. For operation that complies with NEC article 430 in this mode, the external overload protection must be provided by the end user.



Configuring the motor control

Motor protection
Motor overload monitoring (i²xt)

The following two diagrams show the relation between the motor load and tripping time of the monitoring under the following conditions:

- Maximum utilization [0x2D4B:001 \(P308.01\)](#) = 150 %
- Speed compensation [0x2D4B:002 \(P308.02\)](#) = "Off [1]" or output frequency ≥ 40 Hz

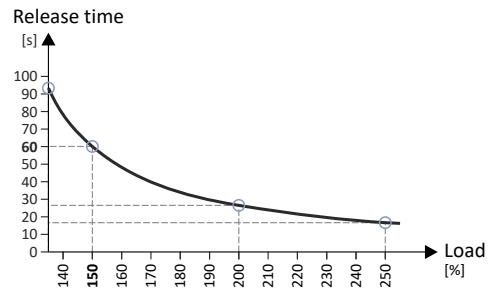
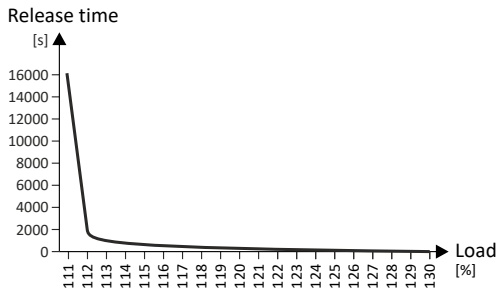

Maximum utilization 60s [%] ▶ 0x2D4B:001 (P308.01)	Load ratio [%]	Tripping time [s]
150	110	Indefinite
150	135	93
150	150	60
150	200	26
150	250	17

Calculation
Load ratio:
Load ratio = actual motor current 0x2D88 (P104.00) / rated motor current 0x6075 (P323.00)
Maximum load ratio for continuous operation at an output frequency ≥ 40 Hz:
Maximum load ratio for continuous operation [%] = 0.73 * maximum utilization 0x2D4B:001 (P308.01)
Release time at an output frequency ≥ 40 Hz and a load ratio > maximum load ratio for continuous operation:
Tripping time [s] ≈ 15.9 / ((load ratio / maximum utilization 0x2D4B:001 (P308.01)) - 0.724) [s]

Configuring the motor control

Motor protection
Motor overload monitoring (i²xt)



Speed compensation for protecting motors at low speed

The inverter has implemented a compensation for low speeds. If the motor is operated with frequencies below 40 Hz, the speed compensation in [0x2D4B:002 \(P308.02\)](#) must be set to "On [0]" (default). This setting ensures that the tripping time for the monitoring is reduced at low speeds, in order to take the reduced self-cooling of AC motors into account.



For UL-compliant operation, speed compensation must also be activated.
[0x2D4B:002 \(P308.02\)](#) = "On [0]".

If speed compensation is activated, the **maximum load ratio for continuous operation** is reduced as follows:

Calculation
Output frequency < 40 Hz: Maximum load ratio for continuous operation = 62.5 % + 37.5 % * output frequency [Hz] / 40 [Hz]
Output frequency ≥ 40 Hz: No reduction

The following diagram shows the reduced release time with activated speed compensation.

- Maximum utilization [0x2D4B:001 \(P308.01\)](#) = 150 %
- Speed compensation [0x2D4B:002 \(P308.02\)](#) = "On [0]"
- Load ratio = 150 %

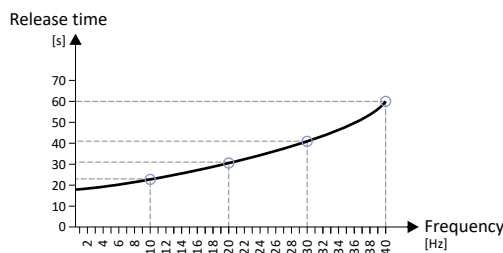

Output frequency	Release time
40 Hz	60 s
30 Hz	≈ 41 s
20 Hz	≈ 31 s
10 Hz	≈ 23 s

The following diagram shows the possible permanent load with activated speed compensation without the monitoring being triggered.

- Maximum utilization [0x2D4B:001 \(P308.01\)](#) = 150 %
- Speed compensation [0x2D4B:002 \(P308.02\)](#) = "On [0]"

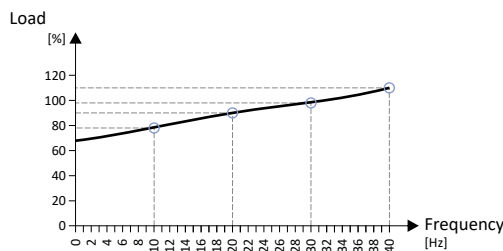

Output frequency	Possible permanent load
40 Hz	110 %
30 Hz	99 %
20 Hz	90 %
10 Hz	79 %

At of 0 Hz, only a load of max. 62.7 % (≈ 62.5 %) is possible. Reference: Load at 40 Hz (69 / 110 * 100 % = 62.7 %). The maximum possible motor load changes proportionally to the setting in [0x2D4B:001 \(P308.01\)](#).

Calculation
Maximum load ratio for continuous operation at an output frequency < 40 Hz: Maximum load ratio for continuous operation = $k_f = 0.625 + 0.375/40 * \text{output frequency}$
Release time at maximum load ratio for continuous operation: Release time at maximum load ratio for continuous operation [%] = $0.73 * k_f * \text{maximum utilization } \text{0x2D4B:001 (P308.01)}$
Release time at an output frequency < 40 Hz and a load ratio > maximum load ratio for continuous operation : Release time [s] ≈ $15.9 / ((\text{load ratio}/\text{maximum utilization } \text{0x2D4B:001 (P308.01)} * k_f) - 0.724)$ [s]

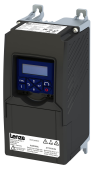

Configuring the motor control

Motor protection Motor overload monitoring (i²xt)

Parameter

Address	Name / setting range / [default setting]	Information
0x2D4B:001 (P308.01)	Motor overload monitoring (i ² xt): Maximum utilisation [60 s] (Motor overload: Max.load.for 60s) 30 ... [150] ... 200 %	Maximum permissible thermal motor utilisation (max. permissible motor current for 60 seconds). <ul style="list-style-type: none"> 100 % = Rated motor current 0x6075 (P323.00) If the motor is actuated with the current set here for 60 seconds, the maximum permissible thermal motor utilisation is reached and the response set in 0x2D4B:003 (P308.03) is executed. If the motor is actuated with a different current, the time period until the motor overload monitoring function is activated is different. Generally the following applies: the lower the current, the lower the thermal utilisation and the later the monitoring function is triggered.
0x2D4B:002 (P308.02)	Motor overload monitoring (i ² xt): Speed compensation (Motor overload: Speed comp.)	Use this function to protect motors that are actuated at a speed below 40 Hz. <ul style="list-style-type: none"> UL-compliant operation with motor overload protection requires the setting "On [0]"!
	0 On	Release time for motor overload monitoring is reduced in order to compensate for the reduced cooling of naturally ventilated AC induction motors during operation at low speed.
	1 Off	Function deactivated, no reduction of the motor overload monitoring release time. May require an external motor overload protection for the UL-compliant operation.
0x2D4B:003 (P308.03)	Motor overload monitoring (i ² xt): Response (Motor overload: Response)	Selection of the response to the triggering of motor overload monitoring. <ul style="list-style-type: none"> UL-compliant operation with motor overload protection requires the setting "error [3]"! If monitoring is deactivated by the setting 0x2D4B:003 (P308.03) = "No response [0]", no motor overload protection is active. In this case, an external motor overload protection can be provided by the user for a UL-compliant operation. Associated error code: <ul style="list-style-type: none"> 9040 0x2350 - CiA: i²xt overload (thermal state)
	0 No response	▶ Error types 456
	1 Warning	
	2 Trouble	
	3 Fault	
0x2D4B:005	Motor overload monitoring (i ² xt): Thermal load <ul style="list-style-type: none"> Read only 	Display of the value of the internal i ² *t integrator. <ul style="list-style-type: none"> 37500 = 100 % thermal load When power is switched off, this value is saved in the internal EEPROM. When power is switched on, the saved value is reloaded into the i²*t integrator. The internal i²*t integrator detects the thermal load based on the load conditions even if the motor overload monitoring is deactivated.
0x2D4F (P123.00)	Motor utilisation (i ² xt) (Mot. i2t utilis.) <ul style="list-style-type: none"> Read only: x % 	Display of the current thermal motor utilisation.

Configuring the motor control

Motor protection
Overcurrent monitoring



10.7.2 Overcurrent monitoring

This function monitors the instantaneous value of the motor current and serves as motor protection.

⚠ WARNING!

With an incorrect parameterization, the maximum permissible motor current may be exceeded in the process.

Possible consequence: Irreversible damage of the motor.

Avoid motor damages by using the overcurrent monitoring function as follows:

- ▶ The setting of the threshold for the overcurrent monitoring in [0x2D46:001 \(P353.01\)](#) must be adapted to the connected motor.
- ▶ Set the maximum current of the inverter in [0x6073 \(P324.00\)](#) much lower than the threshold for overcurrent monitoring for a dynamic limitation of the motor current.

Details

The inverter monitors its output current. This monitoring is independent of the maximum overload current setting. ▶ [Maximum overload current of the inverter](#) [□ 233](#)

- If the instantaneous value of the motor current exceeds the threshold set in [0x2D46:001 \(P353.01\)](#), the response set in [0x2D46:002 \(P353.02\)](#) takes place.
- With the setting [0x2D46:002 \(P353.02\)](#) = "No response [0]", the monitoring function is deactivated.

The threshold for the overcurrent monitoring is preset to four times the rated motor current. This presetting is overwritten in case a motor in the engineering tool is selected from the "motor catalog" or the automatic identification or calibration of the motor data is carried out. For a suitable protection, the automatically adapted setting should be used. If disturbances occur during operation, the value can be increased.

Parameter

Address	Name / setting range / [default setting]	Information
0x2D46:001 (P353.01)	Overcurrent monitoring: Threshold (Overcurr. monit.: Threshold) 0.0 ... [6.8]* ... 1000.0 A * Default setting dependent on the model. <ul style="list-style-type: none">• From version 02.00	Warning/error threshold for overcurrent monitoring of the motor. <ul style="list-style-type: none">• If the active motor current exceeds the set threshold, the response set in 0x2D46:002 (P353.02) is triggered.• The parameter is calculated and set in the course of the automatic identification of the motor.• The parameter can also be set and overwritten by selecting a motor from the "motor catalogue" of the engineering tool or performing an automatic calibration of the motor. ▶ Options for optimizing the control loops □ 207
0x2D46:002 (P353.02)	Overcurrent monitoring: Response (Overcurr. monit.: Response)	Selection of the response to the triggering of motor current monitoring. Associated error code: <ul style="list-style-type: none">• 29056 0x7180 - Motor overcurrent
	0 No response	▶ Error types □ 456
	1 Warning	
	2 Trouble	
	3 Fault	



10.7.3 Motor phase failure detection

The motor phase failure detection function can be activated for both synchronous and asynchronous motors.

Preconditions

Motor phase failure detection during operation is suitable for applications which are operated with a constant load and speed. In other cases, transient processes or unfavourable operating points can cause erroneous triggering to occur.

Details

If a current-carrying motor phase (U, V, W) fails during operation, the response selected in [0x2D45:001 \(P310.01\)](#) is tripped and a logbook entry is made.

Exception: With the setting "No response [0]", no logbook entry is made.

A motor phase failure can only be detected if

1. the rated motor current is higher than 10 % of the rated inverter current and
2. the output frequency is not lower than 0.1 Hz (standstill).

The lower the output frequency the longer the detection of the motor phase failure.

Parameter

Address	Name / setting range / [default setting]	Information
0x2D45:001 (P310.01)	Motor phase failure detection: Response - Motor phase 1 (Mot.phase.fail.: Response)	Selection of the response following the detection of a motor phase failure during operation. Associated error codes: <ul style="list-style-type: none"> • 65289 0xFF09 - Motor phase missing • 65290 0xFF0A - Motor phase failure phase U • 65291 0xFF0B - Motor phase failure phase V • 65292 0xFF0C - Motor phase failure phase W
	0 No response	▶ Error types 456
	1 Warning	
	2 Trouble	
	3 Fault	
0x2D45:002 (P310.02)	Motor phase failure detection: Current threshold (Mot.phase.fail.: Current thresh.) 1.0 ... [5.0] ... 25.0 %	Current threshold for the activation of the motor phase failure detection function. <ul style="list-style-type: none"> • 100 % = Rated motor current 0x6075 (P323.00) • Display of the present motor current in 0x2D88 (P104.00).
0x2D45:003 (P310.03)	Motor phase failure detection: Voltage threshold (Mot.phase.fail.: Voltage thresh.) 0.0 ... [10.0] ... 100.0 V	Voltage threshold for motor phase monitoring for the VFC control mode (0x2C00 (P300.00) = 6). <ul style="list-style-type: none"> • The monitoring function is triggered if the motor current exceeds the rated motor current-dependent current threshold for longer than 20 ms. Rated motor current 0x6075 (P323.00) • In case of the V/f characteristic control, the voltage threshold is considered additionally for the motor phase failure detection. If the motor voltage is higher than the voltage threshold, monitoring is combined with the motor current.

Configuring the motor control

Motor protection
Motor speed monitoring



10.7.4 Motor speed monitoring

This function monitors the motor speed during operation.

Conditions

- In order to detect the current motor speed, the inverter must be enabled and the motor must rotate.
- For an exact monitoring, rated motor speed [0x2C01:004 \(P320.04\)](#) and rated motor frequency [0x2C01:005 \(P320.05\)](#) must be set correctly.
- For motor speed monitoring, it must be ensured that the speed limitation ([0x6080 \(P322.00\)](#) / max. motor speed) has a higher value than the actual monitoring ([0x2D44:001 \(P350.01\)](#)).

Details

- If the motor speed reaches the threshold set in [0x2D44:001 \(P350.01\)](#), the response set in [0x2D44:002 \(P350.02\)](#) takes place.
- With the setting [0x2D44:002 \(P350.02\)](#) = "No response [0]", the monitoring function is deactivated.

Parameter

Address	Name / setting range / [default setting]	Information
0x2D44:001 (P350.01)	Overspeed monitoring: Threshold (Overspeed monit.: Threshold) 50 ... [8000] ... 50000 rpm	Warning/error threshold for motor speed monitoring. <ul style="list-style-type: none">• If the motor speed reaches the threshold set, the response selected in 0x2D44:002 (P350.02) takes place.• The parameter can be set and thus overwritten by selecting a motor in the engineering tool from the "motor catalog".• Depending on the parameter setting of 0x2D44:001 (P350.01) (Overspeed monitoring: threshold), the speed limitation (0x6080 / Max. motor speed) may become active before speed monitoring. ▶ Options for optimizing the control loops 207
0x2D44:002 (P350.02)	Overspeed monitoring: Response (Overspeed monit.: Response)	Selection of the response to the triggering of motor speed monitoring. Associated error code: <ul style="list-style-type: none">• 65286 0xFF06 - Motor overspeed
	0 No response	▶ Error types 456
	1 Warning	
	2 Trouble	
	3 Fault	



10.7.5 Motor torque monitoring

This function limits the motor torque during operation.

Preconditions

The motor torque monitoring can only be used for the following motor control types with speed controller:

- Sensorless control (SL PSM)
- Sensorless vector control (SLVC)

Details

This function sets the internal status signal "Torque limit reached [79]" = TRUE when the maximum possible torque has been reached.

The limits of the monitoring function are selected via [0x2949:001 \(P337.01\)](#) (positive torque limit) and [0x2949:002 \(P337.02\)](#) (negative torque limit). The actual limits can be seen in [0x2949:003 \(P337.03\)](#) (actual positive torque limit), [0x2949:004 \(P337.04\)](#) (actual negative torque limit).

▶ Torque limits [150](#)

- The status signal is set irrespective of the response [0x2D67:001 \(P329.01\)](#) and the delay time [0x2D67:002 \(P329.02\)](#) set for this monitoring.
- The status signal can be used by the user to
 - activate certain functions. ▶ [Flexible I/O configuration \[51\]\(#\)](#)
 - set a digital output. ▶ [Configure digital outputs \[247\]\(#\)](#)
 - set a bit of the NetWordOUT1 mappable data word. ▶ [Motor speed monitoring \[230\]\(#\)](#)

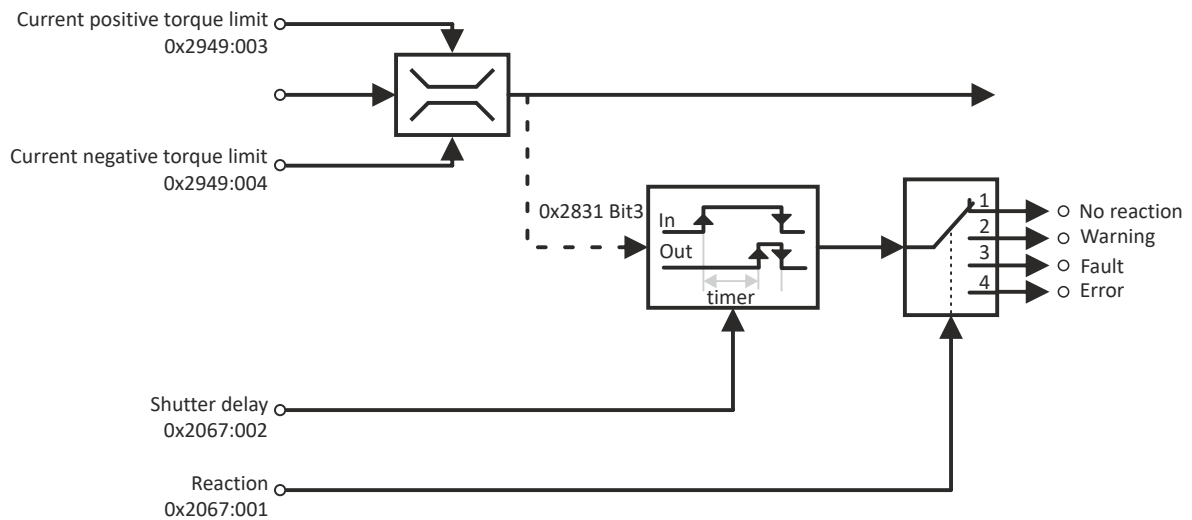

Parameter

Address	Name / setting range / [default setting]	Information
0x2D67:001 (P329.01)	Maximum torque monitoring: Response (MaxTrq.Monitor: Response) • From version 02.00	Selection of response to reaching the maximum possible torque. • The selected response takes place if the status signal "Torque limit reached [79]" = TRUE and the deceleration time set in 0x2D67:002 (P329.02) has elapsed. Associated error code: • 33553 0x8311 - Torque limit reached
	0 No response	▶ Error types 456
	1 Warning	
	2 Trouble	
	3 Fault	

Configuring the motor control

Motor protection
Motor torque monitoring



Address	Name / setting range / [default setting]	Information
0x2D67:002 (P329.02)	Maximum torque monitoring: Triggering delay (MaxTrq.Monitor: Triggering delay) 0.000 ... [0.000] ... 10.000 s • From version 02.00	Optional setting of a deceleration for triggering the response selected in 0x2D67:001 (P329.01) . Typical application: • The motor should be driven at the torque limit for a short time without triggering the selected response. • Only after a longer operation (> set deceleration) at the torque limit, the selected response is to take place.
0x6072 (P326.00)	Max. torque (Max. torque) 0.0 ... [250.0] ... 3000.0 % • From version 02.00	Symmetrical selection of the maximum permissible torque. • 100 % = Rated motor torque 0x6076 (P325.00) • This parameter serves to implement a static and bipolar torque limitation. This can be used, for instance, as overload protection of the mechanical transmission path/elements starting at the motor shaft. • This limitation acts irrespective of the torque limitations acting in unipolar mode that are set in 0x60E0 and 0x60E1 .



Configuring the motor control

Motor protection
Maximum overload current of the inverter

10.7.6 Maximum overload current of the inverter

For the purpose of current limitation, a maximum overload current can be set for the inverter. If the current consumption of the motor exceeds this current limit, the inverter changes its dynamic behaviour, in order to counteract this exceedance.

Details

- The maximum current of the inverter can be set in [0x6073 \(P324.00\)](#).
- Reference for the percentage setting of the maximum overload current is the rated motor current set in [0x6075 \(P323.00\)](#).
- The actual motor current is displayed in [0x2D88 \(P104.00\)](#).



If the change in the dynamic behavior carried out by the inverter does not result in exiting the overcurrent state, the inverter outputs an error.

When [0x6078 \(P103.00\)](#) (current actual value in %) exceeds [0x6073 \(P324.00\)](#) (max. current actual value in %) the message [0x238A](#) is displayed. This status is also displayed in the following network status word bits:

- 0x400C:001 bit 14
- 0x400C:002 bit 2

Load response	Impact
Overload during acceleration in motor mode	A longer time is required for reaching the frequency setpoint than has been set.
Overload during deceleration in generator mode	A longer time than is required for reaching standstill is set.
Increasing load at constant frequency	When the current limit of the motor mode is reached: <ul style="list-style-type: none"> • The inverter reduces the effective speed setpoint until a stable working is set or an effective speed setpoint of 0 rpm is reached. • If the load is reduced, the inverter increases the effective speed setpoint until the setpoint speed is reached or the load reaches the current limit value again.
	When the current limit in the generator mode is reached: <ul style="list-style-type: none"> • The inverter increases the effective speed setpoint until a stable working point is reached or up to the maximum permissible output frequency 0x2916 (P211.00). • If the load is reduced, the inverter reduces the effective speed setpoint until the setpoint speed is reached or the load reaches the current limit value again.
	If an abrupt load is building at the motor shaft (e.g. drive is blocked), the overcurrent switch-off function may respond.

Example: Overcurrent switch-off in case of a sudden load at the motor shaft

Frequency setpoint selection

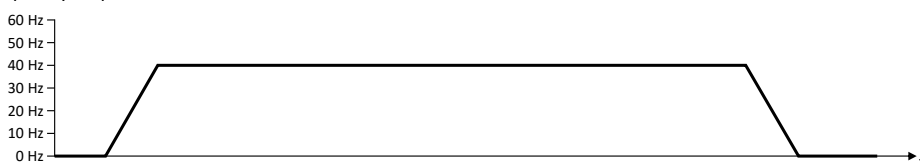

Output frequency

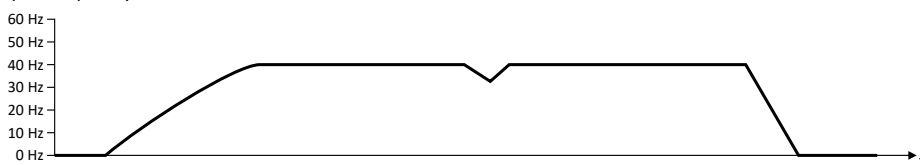

Motor load

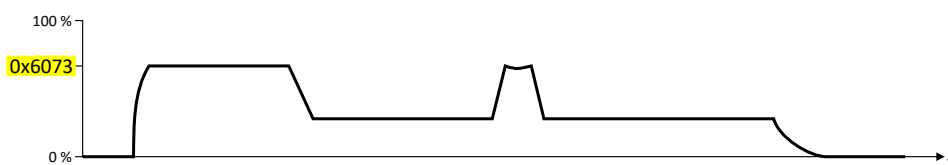

Configuring the motor control

Motor protection

Maximum overload current of the inverter



Parameter

Address	Name / setting range / [default setting]	Information
0x6073 (P324.00)	Max. current (Max. current) 0.0 ... [200.0] ... 3000.0 %	<p>Max. current of the inverter.</p> <ul style="list-style-type: none">• 100 % = Rated motor current (0x6075 (P323.00))• If the current consumption of the motor exceeds this current limit, the inverter changes its dynamic behaviour in order to counteract this exceedance.• If the modified dynamic behaviour fails to eliminate the excess current consumption, the inverter outputs an error. <p>When 0x6078 (P103.00) (current actual value in %) exceeds 0x6073 (P324.00) (max. current actual value in %) the message 0x238A is displayed. This status is also displayed in the following network status word bits:</p> <ul style="list-style-type: none">• 0x400C:001 bit 14• 0x400C:002 bit 2 <p>Note!</p> <p>This parameter is not identical to the ultimate motor current I_{ULT}:</p> <ul style="list-style-type: none">• The value set in 0x2D46:001 (P353.01) (Threshold) is a limit value for synchronous motors to protect their magnets.• The value to be set here should always be considerably below the ultimate motor current.



10.7.7 Heavy load monitoring

If the apparent current of the motor exceeds a defined threshold value due to a heavy duty state, a configurable error is triggered (incl. logbook entry).

Conditions

Monitoring is activated as soon as the motor is running. Monitoring can be deactivated with the setting "No response".

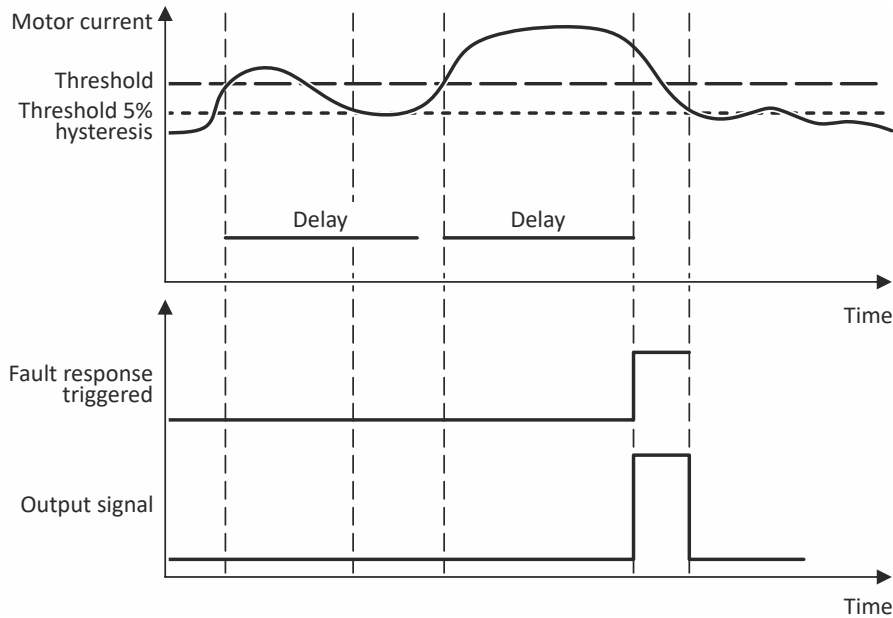

Details

Exceedance of the defined threshold:

- If the actual apparent current exceeds the configured threshold value, the delay time encoder is started.
- If the actual apparent motor current falls below the threshold value minus 5 % (hysteresis - not adjustable), the delay time encoder is set to zero.

Independent of the error response, the output signal (Heavy duty monitoring [84]) is triggered:

- If the actual apparent current of the motor exceeds the threshold for longer than the delay time, the output signal is set to TRUE.
- If the actual apparent current of the motor falls below the threshold value minus 5 % (hysteresis), the output signal is set to FALSE.
- If the delay time is set to 0 seconds, the output signal is immediately set to TRUE.

The error response is activated according to its settings:

- If the actual apparent current of the motor exceeds the threshold value for longer than the configured delay time, the selected error response is activated.
- When the error response is triggered, an entry is generated in the logbook (exception: Error response - Selection [0]): "Motor overload" (error code [65337](#) | [0xFF39](#))

Parameter

Address	Name / setting range / [default setting]	Information
0x4007:001	Heavy load monitoring: Error threshold 0.0 ... [200.0] ... 300.0 % • From version 05.02	When the threshold value for the apparent current of the motor is exceeded, the delay time encoder is started. • 100 % = of rated motor current 0x6075 (P323.00)
0x4007:002	Heavy load monitoring: Delay time 0.0 ... [3.0] ... 999.9 s • From version 05.02	Setting of the delay time.

Configuring the motor control

Motor protection
Heavy load monitoring



Address	Name / setting range / [default setting]	Information
0x4007:003	Heavy load monitoring: Error response <ul style="list-style-type: none">From version 05.02	Setting of the error response. Associated error code: <ul style="list-style-type: none">65337 0xFF39 - Motor overload
	0 No response	▶ Error types □ 456
	1 Warning	
	2 Trouble	
	3 Fault	



11 I/O extensions and control connections

11.1 Configure digital inputs

Settings for digital inputs 1 ... 5.

Details

The digital inputs are used for control tasks. For this purpose, the digital inputs are available as selectable triggers for functions.

The following settings are possible for the digital inputs:

- Debounce time ②
- Inversion ③

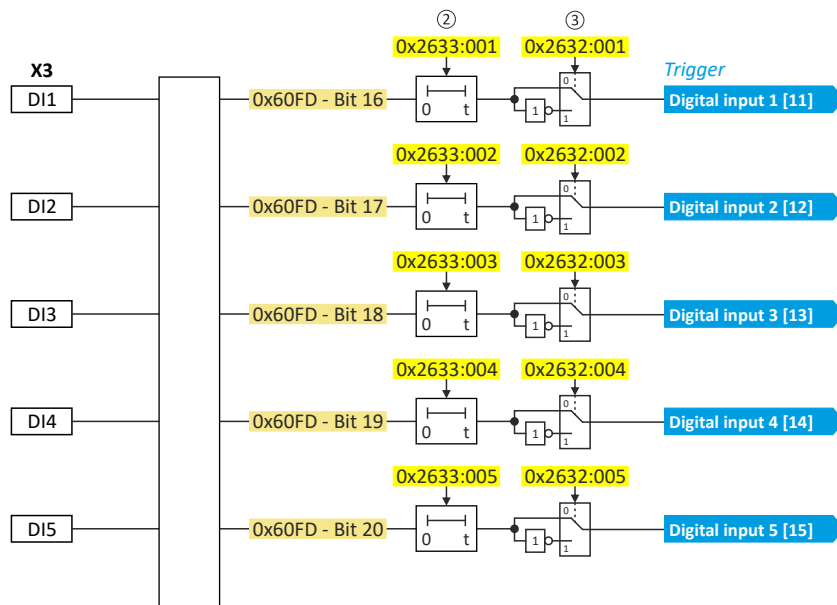

Diagnostic parameters:

- The logic status of the digital inputs is displayed in **0x60FD (P118.00)**.

Assertion level "HIGH active"

HIGH active (default setting)	
•	Internally, the digital input terminals are set to LOW level via pull-down resistors.
•	The current flows from the current supply (e.g. terminal X3/24 V) through the contact to the digital input terminal (and internally via the pull-down resistor to GND).
•	If the contact is closed, the digital input is set to HIGH level and is thus HIGH active.
Connection plan (example):	

Debounce time

To minimize interference pulses, a debounce time of 1 ms is set for all digital inputs. Via »EASY Starter«, the debounce time can be increased individually for each digital input to a maximum of 50 ms if necessary.

I/O extensions and control connections

Configure digital inputs



Inversion

Each digital input can be configured in such a way that the status pending at the terminal is logically inverted internally. This way, a closed contact, for instance, serves to deactivate an assigned function instead of activating it. Thus, the control of the inverter can be flexibly adapted to the requirements of the actual application.

Parameter

Address	Name / setting range / [default setting]	Information
0x2630:001 (P410.01)	Settings for digital inputs: Assertion level (DI settings: Assertion level)	Definition of the internal hardware interconnection of the digital input terminal (X3/DIx).
	0 LOW active	Digital input terminals (X3/DIx) are set to HIGH level via pull-up resistors.
	1 HIGH active	Digital input terminals (X3/DIx) are set to LOW level via pull-down resistors.
0x2630:002 (P410.02)	Settings for digital inputs: Input function (DI settings: Input function)	Input function of the digital terminals DI3 and DI4.
	0 Digital input	DI3 = digital input DI4 = digital input
0x2632:001 (P411.01)	Inversion of digital inputs: Digital input 1 (DI inversion: DI1 inversion)	Inversion of digital input 1
	0 Not inverted	
	1 Inverted	
0x2632:002 (P411.02)	Inversion of digital inputs: Digital input 2 (DI inversion: DI2 inversion)	Inversion of digital input 2
	0 Not inverted	
	1 Inverted	
0x2632:003 (P411.03)	Inversion of digital inputs: Digital input 3 (DI inversion: DI3 inversion)	Inversion of digital input 3
	0 Not inverted	
	1 Inverted	
0x2632:004 (P411.04)	Inversion of digital inputs: Digital input 4 (DI inversion: DI4 inversion)	Inversion of digital input 4
	0 Not inverted	
	1 Inverted	
0x2632:005 (P411.05)	Inversion of digital inputs: Digital input 5 (DI inversion: DI5 inversion)	Inversion of digital input 5
	0 Not inverted	
	1 Inverted	
0x2632:006 (P411.06)	Inversion of digital inputs: Digital input 6 (DI inversion: DI6 inversion) • Only available for application I/O.	Inversion of digital input 6
	0 Not inverted	
	1 Inverted	
0x2632:007 (P411.07)	Inversion of digital inputs: Digital input 7 (DI inversion: DI7 inversion) • Only available for application I/O.	Inversion of digital input 7
	0 Not inverted	
	1 Inverted	
0x2633:001	Digital input debounce time: Digital input 1 1 ... [1] ... 50 ms	Debounce time of digital input 1
0x2633:002	Digital input debounce time: Digital input 2 1 ... [1] ... 50 ms	Debounce time of digital input 2
0x2633:003	Digital input debounce time: Digital input 3 1 ... [1] ... 50 ms	Debounce time of digital input 3
0x2633:004	Digital input debounce time: Digital input 4 1 ... [1] ... 50 ms	Debounce time of digital input 4
0x2633:005	Digital input debounce time: Digital input 5 1 ... [1] ... 50 ms	Debounce time of digital input 5
0x2633:006	Digital input debounce time: Digital input 6 1 ... [1] ... 50 ms • Only available for application I/O.	Debounce time of digital input 6



Address	Name / setting range / [default setting]	Information
0x2633:007	Digital input debounce time: Digital input 7 1 ... [1] ... 50 ms • Only available for application I/O.	Debounce time of digital input 7

Example: Activating two functions simultaneously via digital input 4

The principle of assigning triggers to functions also enables a digital input to be assigned to several functions. The wiring complexity is reduced since there is no necessity to interconnect several digital inputs.

If, for instance, the frequency preset 1 is to be selected via the digital input 4 and a change-over to the acceleration time 2 and deceleration time 2 is to take place at the same time, this can be easily realised by the following parameter setting:

Parameter	Designation	Setting for this example
0x2631:018 (P400.18)	Activate preset (bit 0)	Digital input 4 [14]
0x2631:039 (P400.39)	Activate ramp 2	Digital input 4 [14]



In order to achieve the desired behaviour, the digital input 4 must not be assigned to any further functions!

I/O extensions and control connections

Configure analog inputs
Analog input 1



11.2 Configure analog inputs

11.2.1 Analog input 1

Settings for analog input 1.

Intended use

The analog input 1 can be used for the following tasks:

- As a standard setpoint source

Intended use	Parameter	Setting	Further information
As a setpoint source for specifying a frequency setpoint.	0x2860:001 (P201.01)	Analog input 1 [2]	Frequency control ▶ Standard setpoint source □ 78
As setpoint source for defining the reference value for the process controller.	0x2860:002 (P201.02)	Analog input 1 [2]	Frequency control ▶ Configuring the process controller □ 112
As a setpoint source for defining a torque setpoint.	0x2860:003 (P201.03)	Analog input 1 [2]	Torque control ▶ Standard setpoint source □ 148
As an alternative to the setting as a standard setpoint source, the "Activate AI1 setpoint" 0x2631:014 (P400.14) function can be used to enable a setpoint change-over to the analog input 1.			

- As an actual value source or speed feedforward source for the process controller:

Intended use	Parameter	Setting	Further information
As an actual value source for the process controller.	0x4020:002 (P600.02)	Analog input 1 [1]	Frequency control ▶ Configuring the process controller □ 112
As a speed feedforward source for the process controller.	0x4020:004 (P600.04)	Analog input 1 [2]	

Details

The following settings are possible for the analog input:

- Definition of the input range ①
- Filter time for low-pass filters ②
- Monitoring of the input signal ③
- Dead band for eliminating the smallest signal levels ④
- Definition of the setting range ⑤

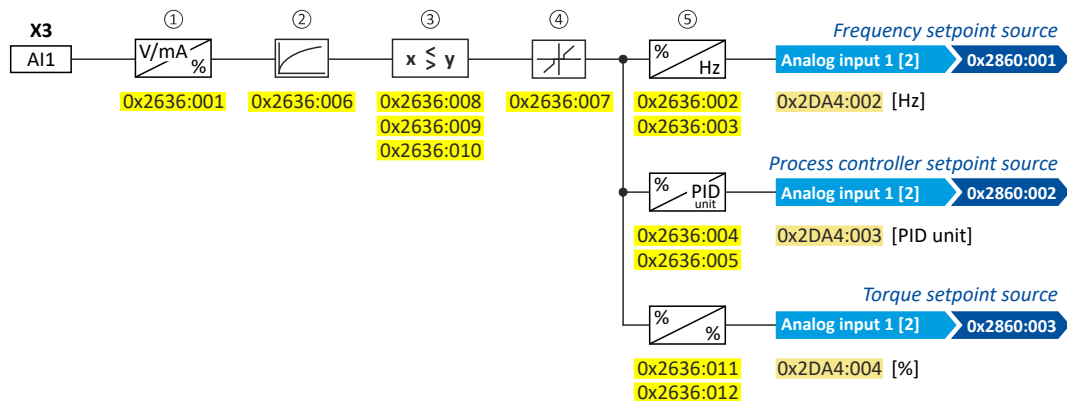

Diagnostic parameters:

- The frequency value is displayed in 0x2DA4:002 (P110.02).
- The process controller value is displayed in 0x2DA4:003 (P110.03).
- The torque value is displayed in 0x2DA4:004 (P110.04).

Definition of the input range

The analog input can be configured as voltage or current input. Internally, the signal is always converted to a value in percent.

Definition of the setting range

The setting range results from the set min and max value for the respective mode.



Configuration examples

Detailed configuration examples can be found in the following subchapters:

- ▶ [Example: Input range 0 ... 10 V = setting range 0 ... 50 Hz](#) 242
- ▶ [Example: Input range 0 ... 10 V = setting range -40 ... +40 Hz](#) 243
- ▶ [Example: Error detection](#) 243

Parameter

Address	Name / setting range / [default setting]	Information
0x2636:001 (P430.01)	Analog input 1: Input range (Analog input 1: AI1 input range)	Definition of the input range.
	0 0 ... 10 VDC	
	1 0 ... 5 VDC	
	2 2 ... 10 VDC	
	3 -10 ... +10 VDC	
	4 4 ... 20 mA	
5 0 ... 20 mA		
0x2636:002 (P430.02)	Analog input 1: Min frequency value (Analog input 1: AI1 freq @ min) -1000.0 ... [0.0] ... 1000.0 Hz	Scaling of the input signal to the frequency value. <ul style="list-style-type: none"> • Direction of rotation according to sign. • The standard setpoint source for operating mode 0x6060 (P301.00) = "MS: Velocity mode [-2]" is selected in 0x2860:001 (P201.01). ▶ Configuring the frequency control 78
0x2636:003 (P430.03)	Analog input 1: Max frequency value (Analog input 1: AI1 freq @ max) Device for 50-Hz mains: -1000.0 ... [50.0] ... 1000.0 Hz Device for 60-Hz mains: -1000.0 ... [60.0] ... 1000.0 Hz	
0x2636:004 (P430.04)	Analog input 1: Min PID value (Analog input 1: AI1 PID @ min) -300.00 ... [0.00] ... 300.00 PID unit	Scaling of the input signal to the PID value. <ul style="list-style-type: none"> • The standard setpoint source for the reference value of PID control is selected in 0x2860:002 (P201.02). ▶ Configuring the process controller 112
0x2636:005 (P430.05)	Analog input 1: Max PID value (Analog input 1: AI1 PID @ max) -300.00 ... [100.00] ... 300.00 PID unit	
0x2636:006 (P430.06)	Analog input 1: Filter time (Analog input 1: AI1 filter time) 0 ... [10] ... 10000 ms	PT1 time constant for low-pass filter. <ul style="list-style-type: none"> • By the use of a low-pass filter, the impacts of noise to an analog signal can be minimised. • For an optimum filter effect, first the noise frequency has to be determined. The time constant then has to be set so that it equals the reciprocal value of the double frequency.
0x2636:007 (P430.07)	Analog input 1: Dead band (Analog input 1: AI1 dead band) 0.0 ... [0.0] ... 100.0 %	Optional setting of a dead band that is placed symmetrically around the frequency zero point. <ul style="list-style-type: none"> • If the analog input value is within the dead band, the output value for the motor control is set to "0". • 100 % = maximum value of analog input (0x2636:003 (P430.03), 0x2636:005 (P430.05), 0x2636:012 (P430.12)) • Example: Dead band 10 % of 50 Hz: -10 V ... 10 V, Dead band -5 Hz ... 5 Hz, 0 V... 10 V, Dead band 0 Hz ... 5 Hz
0x2636:008 (P430.08)	Analog input 1: Monitoring threshold (Analog input 1: AI1 monit.level) -100.0 ... [0.0] ... 100.0 %	Monitoring threshold for analog input 1. <ul style="list-style-type: none"> • 100 % = 10 V (with configuration as voltage input) • 100 % = 20 mA (with configuration as current loop) Exception: In the case of a configured input range 4...20 mA (0x2636:001 [4]), the monitoring is triggered at 2 mA with a monitoring threshold of 0.0 %.
0x2636:009 (P430.09)	Analog input 1: Monitoring condition (Analog input 1: Monitoring cond.)	Monitoring condition for analog input 1. <ul style="list-style-type: none"> • If the selected condition is met, the "Error of analog input 1 active [81]" trigger is set to TRUE. The trigger can be assigned to a function or a digital output. • If the selected condition is met, the error response set in 0x2636:010 (P430.10) takes place.
	0 Input value < trigger threshold	
	1 Input value > trigger threshold	

I/O extensions and control connections

Configure analog inputs
Analog input 1



Address	Name / setting range / [default setting]	Information
0x2636:010 (P430.10)	Analog input 1: Error response (Analog input 1: AI1 error resp.)	Error response for analog input 1. <ul style="list-style-type: none"> The selected response takes place if the monitoring condition selected in 0x2636:009 (P430.09) is met. Associated error code: <ul style="list-style-type: none"> 28801 0x7081 - Fault - Analog input 1
	0 No response	▶ Error types □ 456
	1 Warning	
	2 Trouble	
3 Fault		
0x2636:011 (P430.11)	Analog input 1: Min torque value (Analog input 1: Min. torque) -400.0 ... [0.0] ... 400.0 % <ul style="list-style-type: none"> From version 03.00 	Scaling of the input signal to the torque value. <ul style="list-style-type: none"> 100 % = permissible maximum torque 0x6072 (P326.00) Direction of rotation according to sign. The standard setpoint source for operating mode 0x6060 (P301.00) = "MS: Torque mode [-1]" is selected in 0x2860:003 (P201.03). ▶ Configuring the torque control □ 146
0x2636:012 (P430.12)	Analog input 1: Max torque value (Analog input 1: Max. torque) -400.0 ... [100.0] ... 400.0 % <ul style="list-style-type: none"> From version 03.00 	

11.2.1.1 Example: Input range 0 ... 10 V = setting range 0 ... 50 Hz

In this configuration, for instance, a frequency setpoint between 0 and 50 Hz can be set with a potentiometer connected to the analog input.

Connection plan	Function
	Potentiometer R1 Frequency setpoint definition (Input voltage 1 V = 5 Hz)

Parameter	Designation	Setting for this example
0x2636:001 (P430.01)	Analog input 1: Input range	0 ... 10 VDC [0]
0x2636:002 (P430.02)	Analog input 1: Min frequency value	0.0 Hz
0x2636:003 (P430.03)	Analog input 1: Max frequency value	50.0 Hz
0x2636:006 (P430.06)	Analog input 1: Filter time	10 ms

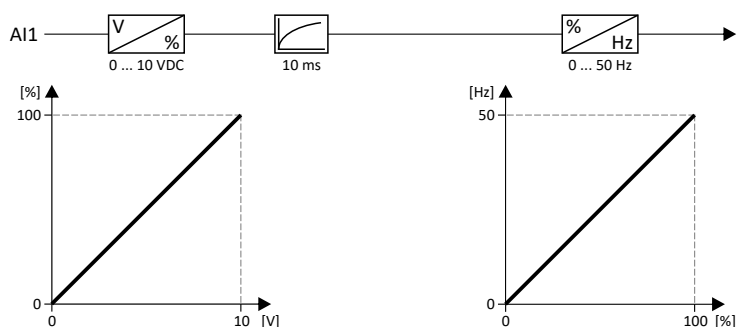



I/O extensions and control connections

Configure analog inputs
Analog input 1

11.2.1.2 Example: Input range 0 ... 10 V = setting range -40 ... +40 Hz

In this example, a bipolar setting range and a dead band with 2 % are configured.

Parameter	Designation	Setting for this example
0x2636:001 (P430.01)	Analog input 1: Input range	0 ... 10 VDC [0]
0x2636:002 (P430.02)	Analog input 1: Min frequency value	-40.0 Hz
0x2636:003 (P430.03)	Analog input 1: Max frequency value	40.0 Hz
0x2636:006 (P430.06)	Analog input 1: Filter time	10 ms
0x2636:007 (P430.07)	Analog input 1: Dead band	2.0 %

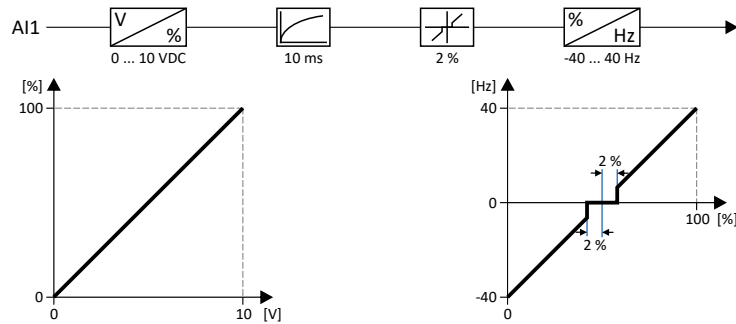

11.2.1.3 Example: Error detection

In this example, the digital output 1 is set via the trigger "Error of analog input 1 active [81]" if the percentage input value is lower than 10 %. Additionally, a warning is output.

Parameter	Designation	Setting for this example
0x2634:002 (P420.02)	Digital outputs function: Digital output 1	Error of analog input 1 active [81]
0x2636:001 (P430.01)	Analog input 1: Input range	0 ... 10 VDC [0]
0x2636:002 (P430.02)	Analog input 1: Min frequency value	0.0 Hz
0x2636:003 (P430.03)	Analog input 1: Max frequency value	40.0 Hz
0x2636:006 (P430.06)	Analog input 1: Filter time	10 ms
0x2636:008 (P430.08)	Analog input 1: Monitoring threshold	10.0 %
0x2636:009 (P430.09)	Analog input 1: Monitoring condition	Input value < trigger threshold [0]
0x2636:010 (P430.10)	Analog input 1: Error response	Warning [1]

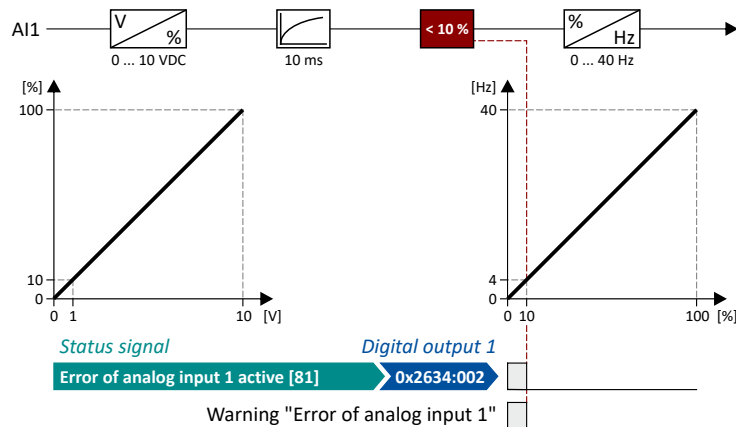

I/O extensions and control connections

Configure analog inputs
Analog input 2



11.2.2 Analog input 2

Settings for analog input 2.

Intended use

The analog input 2 can be used for the following tasks:

- As a standard setpoint source

Intended use	Parameter	Setting	Further information
As a setpoint source for specifying a frequency setpoint.	0x2860:001 (P201.01)	Analog input 1 [3]	Frequency control ▶ Standard setpoint source ☐ 78
As setpoint source for defining the reference value for the process controller.	0x2860:002 (P201.02)	Analog input 1 [3]	Frequency control ▶ Configuring the process controller ☐ 112
As a setpoint source for defining a torque setpoint.	0x2860:003 (P201.03)	Analog input 1 [3]	Torque control ▶ Standard setpoint source ☐ 148

As an alternative to the setting as a standard setpoint source, the "Activate AI2 setpoint" 0x2631:015 (P400.15) function can be used to enable a setpoint change-over to the analog input 2.

- As an actual value source or speed feedforward source for the process controller:

Intended use	Parameter	Setting	Further information
As an actual value source for the process controller.	0x4020:002 (P600.02)	Analog input 2 [2]	Frequency control ▶ Configuring the process controller ☐ 112
As a speed feedforward source for the process controller.	0x4020:004 (P600.04)	Analog input 2 [3]	

Details

The following settings are possible for the analog input:

- Definition of the input range ①
- Filter time for low-pass filters ②
- Monitoring of the input signal ③
- Dead band for eliminating the smallest signal levels ④
- Definition of the setting range ⑤

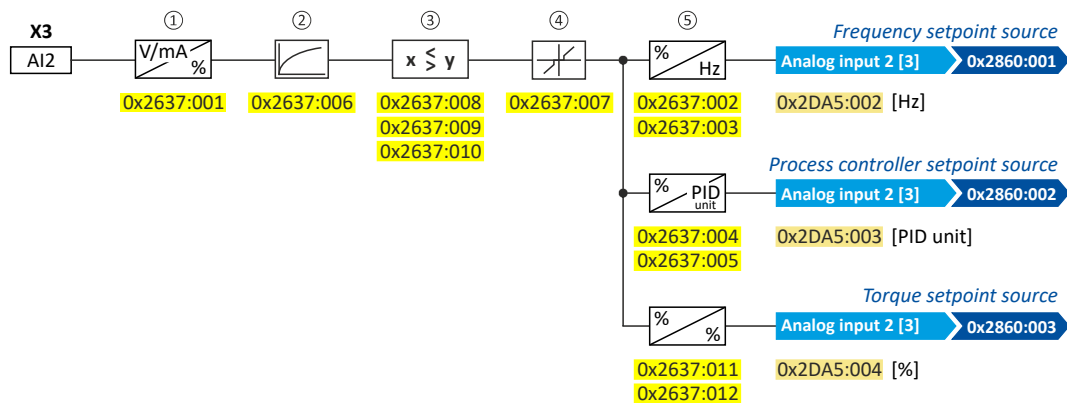

Diagnostic parameters:

- The frequency value is displayed in 0x2DA5:002 (P111.02).
- The process controller value is displayed in 0x2DA5:003 (P111.03).
- The torque value is displayed in 0x2DA5:004 (P111.04).

For further details and configuration examples, see chapter "Analog input 1". ☐ 240

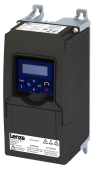

I/O extensions and control connections

Configure analog inputs
Analog input 2

Parameter

Address	Name / setting range / [default setting]	Information
0x2637:001 (P431.01)	Analog input 2: Input range (Analog input 2: AI2 input range)	Definition of the input range.
	0 0 ... 10 VDC	
	1 0 ... 5 VDC	
	2 2 ... 10 VDC	
	3 -10 ... +10 VDC	
	4 4 ... 20 mA	
5 0 ... 20 mA		
0x2637:002 (P431.02)	Analog input 2: Min frequency value (Analog input 2: AI2 freq @ min) -1000.0 ... [0.0] ... 1000.0 Hz	Scaling of the input signal to the frequency value. <ul style="list-style-type: none"> Direction of rotation according to sign. The standard setpoint source for operating mode 0x6060 (P301.00) = "MS: Velocity mode [-2]" is selected in 0x2860:001 (P201.01). <ul style="list-style-type: none"> ▶ Configuring the frequency control 478
0x2637:003 (P431.03)	Analog input 2: Max frequency value (Analog input 2: AI2 freq @ max) Device for 50-Hz mains: -1000.0 ... [50.0] ... 1000.0 Hz Device for 60-Hz mains: -1000.0 ... [60.0] ... 1000.0 Hz	
0x2637:004 (P431.04)	Analog input 2: Min PID value (Analog input 2: AI2 PID @ min) -300.00 ... [0.00] ... 300.00 PID unit	Scaling of the input signal to the PID value. <ul style="list-style-type: none"> The standard setpoint source for the reference value of PID control is selected in 0x2860:002 (P201.02). <ul style="list-style-type: none"> ▶ Configuring the process controller 112
0x2637:005 (P431.05)	Analog input 2: Max PID value (Analog input 2: AI2 PID @ max) -300.00 ... [100.00] ... 300.00 PID unit	
0x2637:006 (P431.06)	Analog input 2: Filter time (Analog input 2: AI2 filter time) 0 ... [10] ... 10000 ms	PT1 time constant for low-pass filter. <ul style="list-style-type: none"> By the use of a low-pass filter, the impacts of noise to an analog signal can be minimised. For an optimum filter effect, first the noise frequency has to be determined. The time constant then has to be set so that it equals the reciprocal value of the double frequency.
0x2637:007 (P431.07)	Analog input 2: Dead band (Analog input 2: AI2 dead band) 0.0 ... [0.0] ... 100.0 %	Optional setting of a dead band that is placed symmetrically around the frequency zero point. <ul style="list-style-type: none"> If the analog input value is within the dead band, the output value for the motor control is set to "0". 100 % = maximum value of analog input (0x2636:003 (P430.03), 0x2636:005 (P430.05), 0x2636:012 (P430.12)) Example: Dead band 10 % of 50 Hz: -10 V ... 10 V, Dead band -5 Hz ... 5 Hz, 0 V ... 10 V, Dead band 0 Hz ... 5 Hz
0x2637:008 (P431.08)	Analog input 2: Monitoring threshold (Analog input 2: AI2 monit.level) -100.0 ... [0.0] ... 100.0 %	Monitoring threshold for analog input 2. <ul style="list-style-type: none"> 100 % = 10 V (with configuration as voltage input) 100 % = 20 mA (with configuration as current loop) <p>Exception: In the case of a configured input range 4...20 mA (0x2636:001 [4]), the monitoring is triggered at 2 mA with a monitoring threshold of 0.0 %.</p>
0x2637:009 (P431.09)	Analog input 2: Monitoring condition (Analog input 2: Monitoring cond.)	Monitoring condition for analog input 2. <ul style="list-style-type: none"> If the selected condition is met, the "Error of analog input 2 active [82]" trigger is set to TRUE. The trigger can be assigned to a function or a digital output. If the selected condition is met for at least 500 ms, the error response set in 0x2637:010 (P431.10) takes place.
	0 Input value < trigger threshold	
	1 Input value > trigger threshold	
0x2637:010 (P431.10)	Analog input 2: Error response (Analog input 2: AI2 error resp.)	Error response for analog input 2. <ul style="list-style-type: none"> The selected response takes place if the monitoring condition selected in 0x2637:009 (P431.09) is met for at least 500 ms. <p>Associated error code:</p> <ul style="list-style-type: none"> 28802 0x7082 - Analog input 2 fault <ul style="list-style-type: none"> ▶ Error types 456
	0 No response	
	1 Warning	
	2 Trouble	
	3 Fault	

I/O extensions and control connections

Configure analog inputs
Analog input 2



Address	Name / setting range / [default setting]	Information
0x2637:011 (P431.11)	Analog input 2: Min torque value (Analog input 2: Min. torque) -400.0 ... [0.0] ... 400.0 % <ul style="list-style-type: none">• From version 03.00	Scaling of the input signal to the torque value. <ul style="list-style-type: none">• 100 % = permissible maximum torque 0x6072 (P326.00)• Direction of rotation according to sign.• The standard setpoint source for operating mode 0x6060 (P301.00) = "MS: Torque mode [-1]" is selected in 0x2860:003 (P201.03). ▶ Configuring the torque control □ 146
0x2637:012 (P431.12)	Analog input 2: Max torque value (Analog input 2: Max. torque) -400.0 ... [100.0] ... 400.0 % <ul style="list-style-type: none">• From version 03.00	



11.3 Configure digital outputs

11.3.1 Relay output

Settings for the relay.



Relay only switches if the inverter is supplied with 240 V or 400 V.

Use a corresponding suppressor circuit in case of an inductive or capacitive load!

Details

The relay is controlled with the trigger selected in [0x2634:001 \(P420.01\)](#).

The following settings are possible for the relay:

- Inversion ①
- Switch-on delay ②
- Cutout delay ③

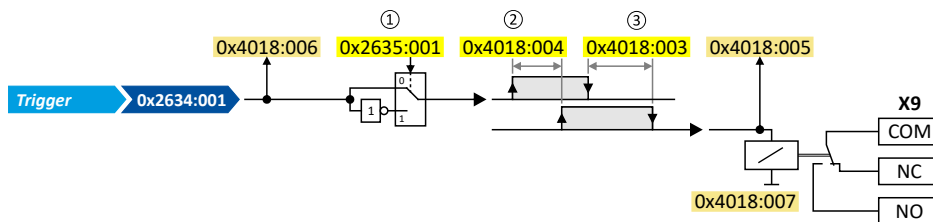

Diagnostic parameters:

- The logic status of the trigger signal is displayed in [0x4018:006](#).
- The logic status of the relay is displayed in [0x4018:005](#).
- The current switching cycles of the relay are shown in [0x4018:007](#).

Parameter

Address	Name / setting range / [default setting]	Information
0x2634:001 (P420.01)	Digital outputs function: Relay (Dig.out.function: Relay function)	Assignment of a trigger to the relay. Trigger = FALSE: X9/NO-COM open and NC-COM closed. Trigger = TRUE: X9/NO-COM closed and NC-COM open. Notes: • An inversion set in 0x2635:001 (P421.01) is taken into consideration here.
0	Not connected	No trigger assigned (trigger is constantly FALSE).
1	Constant TRUE	Trigger is constantly TRUE.
11	Digital input 1	State of X3/DI1, taking an inversion set in 0x2632:001 (P411.01) into consideration.
12	Digital input 2	State of X3/DI2, taking an inversion set in 0x2632:002 (P411.02) into consideration.
13	Digital input 3	State of X3/DI3, taking an inversion set in 0x2632:003 (P411.03) into consideration.
14	Digital input 4	State of X3/DI4, taking an inversion set in 0x2632:004 (P411.04) into consideration.
15	Digital input 5	State of X3/DI5, taking an inversion set in 0x2632:005 (P411.05) into consideration.
16	Digital input 6	State of X3/DI6, taking an inversion set in 0x2632:006 (P411.06) into consideration.
17	Digital input 7	State of X3/DI7, taking an inversion set in 0x2632:007 (P411.07) into consideration.
30	NetWordIN1 - bit 12	State of NetWordIN1/bit 12 ... 15. • Display of NetWordIN1 in 0x4008:001 (P590.01) . • For implementing an individual control word format, NetWordIN1 can be mapped to a process data input word.
31	NetWordIN1 - bit 13	
32	NetWordIN1 - bit 14	
33	NetWordIN1 - bit 15	

I/O extensions and control connections

Configure digital outputs

Relay output



Address	Name / setting range / [default setting]	Information
34	NetWordIN2 - bit 0	State of NetWordIN2/bit 0 ... bit 15. • Display of NetWordIN2 in 0x4008:002 (P590.02) . • For controlling the digital outputs via network, NetWordIN2 can be mapped to a process data input word.
35	NetWordIN2 - bit 1	
36	NetWordIN2 - bit 2	
37	NetWordIN2 - bit 3	
38	NetWordIN2 - bit 4	
39	NetWordIN2 - bit 5	
40	NetWordIN2 - bit 6	
41	NetWordIN2 - bit 7	
42	NetWordIN2 - bit 8	
43	NetWordIN2 - bit 9	
44	NetWordIN2 - bit 10	
45	NetWordIN2 - bit 11	
46	NetWordIN2 - bit 12	
47	NetWordIN2 - bit 13	
48	NetWordIN2 - bit 14	
49	NetWordIN2 - bit 15	
50	Running	TRUE if inverter and start are enabled and output frequency > 0 Hz. Otherwise FALSE. Exception, quick stop mode: TRUE if inverter and start are enabled and output frequency > 0.2 Hz. Otherwise FALSE.
51	Ready for operation	TRUE, wenn Inverter betriebsbereit (kein Fehler aktiv und Zwischenkreisspannung ok). Sonst FALSE.
52	Operation enabled	TRUE if inverter and start are enabled. Otherwise FALSE.
53	Stop active	TRUE if inverter is enabled and motor is not started and output frequency = 0.
54	Quick stop active	TRUE if quick stop is active. Otherwise FALSE.
55	Inverter disabled (safety)	Function is not supported in this device.
56	Fault active	TRUE if error is active. Otherwise FALSE.
57	Error (non-resettable) active	TRUE if non-resettable error is active. Otherwise FALSE.
58	Device warning active	TRUE if warning is active. Otherwise FALSE. • A warning has no impact on the operating status of the inverter. • A warning is reset automatically if the cause has been eliminated.
59	Device trouble active	TRUE if a fault is active. Otherwise FALSE. • In the event of a fault, the motor is brought to a standstill with the quick stop ramp. The inverter is then disabled. • Exception: In case of a serious fault, the inverter is disabled immediately. The motor has no torque (coasts). • The error state will be left automatically if the error condition is not active anymore. • The restart behaviour after trouble can be configured. ▶ Automatic restart after a fault □ 361
60	Heatsink temperature warning active	TRUE if current heatsink temperature > warning threshold for temperature monitoring. Otherwise FALSE. • Display of the current heatsink temperature in 0x2D84:001 (P117.01) . • Setting of the warning threshold in 0x2D84:002 .
66	Flying restart circuit active	TRUE if flying restart circuit active is active. Otherwise FALSE. ▶ Flying restart circuit □ 182
67	DC braking active	TRUE if DC braking is active. Otherwise FALSE. ▶ DC braking □ 190
68	Stop command active	TRUE if delay to standstill active. Otherwise FALSE.
69	Rotational direction reversed	TRUE if output frequency is negative. Otherwise FALSE.
70	Frequency threshold exceeded	TRUE if current output frequency > frequency threshold. Otherwise FALSE. • Display of the current output frequency in 0x2DDD (P100.00) . • Setting Frequency threshold in 0x4005 (P412.00) . ▶ Trigger action if a frequency threshold is exceeded □ 381
71	Actual speed = 0	TRUE if actual output frequency = 0 Hz (± 0.3 Hz), irrespective of the operating mode. Otherwise FALSE. • Display of the current output frequency in 0x2DDD (P100.00) .



I/O extensions and control connections

Configure digital outputs
Relay output

Address	Name / setting range / [default setting]	Information
72	Setpoint speed reached	TRUE if frequency setpoint reached. Otherwise FALSE.
73	PID feedback = setpoint	TRUE if the controlled feedback variable = process controller setpoint (\pm in 0x404D:003 (P608.03) set hysteresis). Otherwise FALSE. ▶ Configuring the process controller 112
74	PID sleep mode active	TRUE if the inverter is in "PID sleep mode". Otherwise FALSE. ▶ Process controller sleep mode 119
75	PID MIN alarm active	TRUE if feedback variable (with activated PID control) < MIN alarm threshold. Otherwise FALSE. • Setting of MIN alarm threshold in 0x404D:001 (P608.01). ▶ Configuring the process controller 112
76	PID MAX alarm active	TRUE if the feedback variable (with activated PID control) > MAX alarm threshold. Otherwise FALSE. • Setting of MAX alarm threshold in 0x404D:002 (P608.02). ▶ Configuring the process controller 112
77	PID MIN-MAX alarm active	TRUE if no PID alarm is active with activated PID control (MIN alarm threshold < feedback variable < MAX alarm threshold). Otherwise FALSE. • Setting of MIN alarm threshold in 0x404D:001 (P608.01). • Setting of MAX alarm threshold in 0x404D:002 (P608.02). ▶ Configuring the process controller 112
78	Current limit reached	TRUE if current motor current \geq maximum current. Otherwise FALSE. • Display of the present motor current in 0x2D88 (P104.00). • Setting for the maximum current in 0x6073 (P324.00).
79	Torque limit reached	TRUE if torque limit has been reached or exceeded. Otherwise FALSE. • Setting "Actual positive torque limit" in 0x2949:003 (P337.03). • Setting Actual negative torque limit in 0x2949:004 (P337.04). ▶ Motor torque monitoring 231
81	Error of analog input 1 active	TRUE if the monitoring of the input signal at the analog input 1 has responded. Otherwise FALSE. This trigger is set as a function of the following settings: • Monitoring threshold 0x2636:008 (P430.08) • Monitoring condition 0x2636:009 (P430.09) The setting of the Error response in 0x2636:010 (P430.10) has no effect on this trigger. ▶ Analog input 1 240
82	Error of analog input 2 active	TRUE if the monitoring of the input signal at the analog input 2 has responded. Otherwise FALSE. This trigger is set as a function of the following settings: • Monitoring threshold 0x2637:008 (P431.08) • Monitoring condition 0x2637:009 (P431.09) The setting of the Error response in 0x2637:010 (P431.10) has no effect on this trigger. ▶ Analog input 2 244
83	Load loss detected	TRUE if actual motor current < threshold for load loss detection after delay time of the load loss detection has elapsed. Otherwise FALSE. • Display of the actual current in 0x6078 (P103.00). • Setting Threshold in 0x4006:001 (P710.01). • Setting Delay time in 0x4006:002 (P710.02). ▶ Load loss detection 206
84	Heavy load monitoring	TRUE if the actual apparent current of the motor exceeds the threshold for longer than the delay time. FALSE if the actual apparent current of the motor falls below the threshold value minus 5 % (hysteresis). ▶ Heavy load monitoring 235
100	Sequencer controlled (from version 03.00)	The control is executed via the sequencer (according to the configuration of the digital outputs for the current segment). ▶ Segment configuration 89
101	Sequence active (from version 03.00)	Status signal of the "sequencer" function: TRUE if the sequence is running and is currently not suspended. ▶ Sequencer 87
102	Sequence suspended (from version 03.00)	Status signal of the "sequencer" function: TRUE if the sequence is currently suspended. ▶ Sequencer 87

I/O extensions and control connections

Configure digital outputs

Relay output



Address	Name / setting range / [default setting]	Information
103	Sequence done (from version 03.00)	Status signal of the "sequencer" function: TRUE if the sequence is completed (final segment has been passed through). ▶ Sequencer □ 87
104	Local control active	TRUE if local keypad control ("LOC") active. Otherwise FALSE.
105	Remote control active	TRUE if remote control ("REM") via terminals, network, etc. active. Otherwise FALSE.
106	Manual setpoint selection active	TRUE if manual setpoint selection ("MAN") via keypad active. Otherwise FALSE. • Selection of the trigger for the "Activate keypad setpoint" function in 0x2631:016 (P400.16) .
107	Automatic setpoint selection active	TRUE if automatic setpoint selection ("AUTO") via terminals, network, etc. active. Otherwise FALSE.
108	Parameter set 1 active	TRUE if parameter set 1 is loaded and active. Otherwise FALSE.
109	Parameter set 2 active	TRUE if parameter set 2 is loaded and active. Otherwise FALSE.
110	Parameter set 3 active	TRUE if parameter set 3 is loaded and active. Otherwise FALSE.
111	Parameter set 4 active	TRUE if parameter set 4 is loaded and active. Otherwise FALSE.
112	Parameter set load OK	TRUE after any parameter set has been loaded. Otherwise FALSE.
113	Parameter set load fail	TRUE if any of the parameter sets could not be loaded. Otherwise FALSE.
115	Release holding brake	Trigger signal for releasing the holding brake (TRUE = release holding brake). Note! If this trigger is assigned to the relay or a digital output, the deceleration times set for the respective output are not effective (are internally set to "0"). Only the deceleration time set in 0x2820:012 (P712.12) for closing the holding brake influences in this case the time-dependent behaviour of the output. ▶ Holding brake control □ 197
117	Motor phase failure	TRUE if a motor phase failure has been detected. Otherwise FALSE. Note! In the "SLSM-PSM" motor control mode, detection for motor phase failure is deactivated if HF injection is active in the low-speed range. ▶ Motor phase failure detection □ 229
118	UPS operation active	TRUE if UPS operation is active. Otherwise FALSE. ▶ Operation with UPS □ 391
155	STO active	Function is not supported in this device.
160	Assist pump 1	Trigger signal of the cascade function for the activation of additional pump 1 (TRUE = activate additional pump 1). ▶ Cascade function for pumps and fans □ 394
161	Assist pump 2	Trigger signal of the cascade function for the activation of additional pump 2 (TRUE = activate additional pump 2). ▶ Cascade function for pumps and fans □ 394
201	Internal value	Internal values of the manufacturer.
202	Internal value	
203	Internal value	
204	Internal value	
205	Internal value	
206	Internal value	
0x2635:001 (P421.01)	Inversion of digital outputs: Relay (DO inversion: Relay inverted) 0 Not inverted 1 Inverted	Relay inversion
0x4018:003	Relay: Switch-off delay 0.000 ... [0.000] ... 65.535 s	Switch-off delay for the relay. Note! The set delay time is not effective (internally set to "0") if the relay is assigned to the trigger "Release holding brake [115]". Only the deceleration time set in 0x2820:012 (P712.12) for closing the holding brake influences the time-dependent behaviour of the relay.



I/O extensions and control connections

Configure digital outputs
Digital output 1

Address	Name / setting range / [default setting]	Information
0x4018:004	Relay: Switch-on delay 0.000 ... [0.000] ... 65.535 s	Switch-on delay for the relay. Note! The set delay time is not effective (internally set to "0") if the relay is assigned to the trigger "Release holding brake [115]". Only the deceleration time set in 0x2820:012 (P712.12) for closing the holding brake influences the time-dependent behaviour of the relay.
0x4018:005	Relay: Relay state • Read only	Display of the logic state of the relay.
	0 FALSE	
	1 TRUE	
0x4018:006	Relay: Trigger signal state • Read only	Display of the logic state of the trigger signal for the relay (without taking a ON/OFF delay set and inversion into consideration).
	0 FALSE	
	1 TRUE	
0x4018:007	Relay: Switching cycles • Read only	Display of the previous relay switching cycles.

11.3.2 Digital output 1

Settings for digital output 1.

Details

The digital output 1 is controlled with the trigger selected in 0x2634:002 (P420.02).

The following settings are possible for the digital output:

- Inversion ①
- Switch-on delay ②
- Cutout delay ③

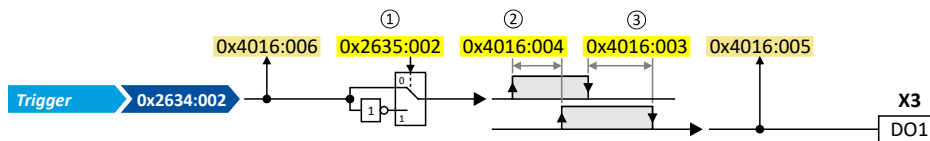

Diagnostic parameters:

- The logic status of the trigger signal is displayed in 0x4016:006.
- The logic status of the digital output is displayed in 0x4016:005.

Parameter

Address	Name / setting range / [default setting]	Information
0x2634:002 (P420.02)	Digital outputs function: Digital output 1 (Dig.out.function: DO1 function) • For further possible settings, see parameter 0x2634:001 (P420.01). □ 247	Assignment of a trigger to digital output 1. Trigger = FALSE: X3/DO1 set to LOW level. Trigger = TRUE: X3/DO1 set to HIGH level. Notes: • An inversion set in 0x2635:002 (P421.02) is taken into consideration here.
	115 Release holding brake	Trigger signal for releasing the holding brake (TRUE = release holding brake). Note! If this trigger is assigned to the relay or a digital output, the deceleration times set for the respective output are not effective (are internally set to "0"). Only the deceleration time set in 0x2820:012 (P712.12) for closing the holding brake influences in this case the time-dependent behaviour of the output. ▶ Holding brake control □ 197
	100 Sequencer controlled (from version 03.00)	The control is executed via the sequencer (according to the configuration of the digital outputs for the current segment). ▶ Segment configuration □ 89
0x2635:002 (P421.02)	Inversion of digital outputs: Digital output 1 (DO inversion: DO1 inversion)	Inversion of digital output 1
	0 Not inverted	
	1 Inverted	

I/O extensions and control connections

Configure digital outputs

Digital output 1



Address	Name / setting range / [default setting]	Information
0x4016:003	Digital output 1: Cutout delay 0.000 ... [0.000] ... 65.535 s	Switch-off delay for digital output 1. Note! The set delay time is not effective (internally set to "0") if the relay is assigned to the trigger "Release holding brake [115]". Only the deceleration time set in 0x2820:012 (P712.12) for closing the holding brake influences the time-dependent behaviour of the digital output.
0x4016:004	Digital output 1: Switch-on delay 0.000 ... [0.000] ... 65.535 s	Switch-on delay for digital output 1. Note! The set delay time is not effective (internally set to "0") if the relay is assigned to the trigger "Release holding brake [115]". Only the deceleration time set in 0x2820:012 (P712.12) for closing the holding brake influences the time-dependent behaviour of the digital output.
0x4016:005	Digital output 1: Terminal state • Read only 0 FALSE 1 TRUE	Display of the logic state of output terminal X3/DO1.
0x4016:006	Digital output 1: Trigger signal state • Read only 0 FALSE 1 TRUE	Display of the logic state of the trigger signal for digital output 1 (without taking a ON/OFF delay set and inversion into consideration).



11.4 Configure analog outputs

11.4.1 Analog output 1

Settings for analog output 1.

Details

The analog output 1 is controlled with the signal selected in [0x2639:002 \(P440.02\)](#).

The following settings are possible for the analog output:

- Definition of the signal range ①
- Definition of the output range ②

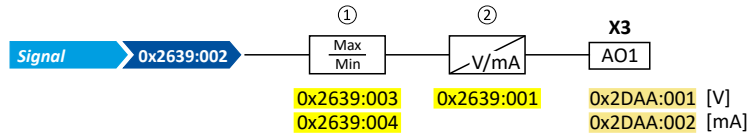

Diagnostic parameters:

- The current output voltage is displayed in [0x2DAA:001 \(P112.01\)](#).
- The actual output current is displayed in [0x2DAA:002 \(P112.02\)](#).

Definition of the signal range

The signal range results from the resolution of the selected signal multiplied by the set min and max signal value. Signals outside the signal range are cut off. For examples, see the following table:

Signal	Resolution	Min. signal	Max. signal	Signal range
0x2639:002 (P440.02)		0x2639:003 (P440.03)	0x2639:004 (P440.04)	
Output frequency	0.1 Hz	0	1000	0 ... 100.0 Hz
Frequency setpoint	0.1 Hz	0	1000	0 ... 100.0 Hz
Analog input 1	0.1 %	0	1000	0 ... 100.0 %
Analog input 2	0.1 %	0	1000	0 ... 100.0 %
Motor current	0.1 A	0	100	0 ... 10.0 A
Output power	0.001 kW	0	250	0 ... 0.250 kW
Actual torque	0.1 % *	0	1000	0 ... 100.0 % *
NetWordIN3	0.1 %	200	500	20.0 ... 50.0 %
NetWordIN4	0.1 %	0	250	0 ... 25.0 %

* 100 % = Rated motor torque [0x6076 \(P325.00\)](#)

Definition of the output range

The analog output can be configured as voltage source or current source. The output range selected in [0x2639:001 \(P440.01\)](#) then corresponds to the configured signal range.

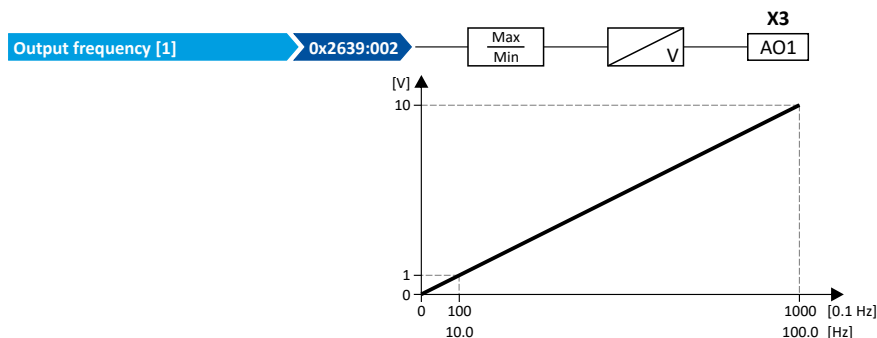

Configuration examples

Detailed configuration examples can be found in the following subchapters:

- ▶ Example: Output voltage 0 ... 10 V = output frequency 0 ... 100 Hz [255](#)
- ▶ Example: Output voltage 2 ... 10 V = output frequency 30 ... 60 Hz [255](#)
- ▶ Example: mirrored output range [256](#)

I/O extensions and control connections

Configure analog outputs

Analog output 1



Parameter

Address	Name / setting range / [default setting]	Information
0x2639:001 (P440.01)	Analog output 1: Output range (Analog output 1: AO1 outp. range)	Definition of the output range.
	0 Inhibited	
	1 0 ... 10 VDC	
	2 0 ... 5 VDC	
	3 2 ... 10 VDC	
	4 4 ... 20 mA	
	5 0 ... 20 mA	
	11 0 ... 10 VDC (mirrored)	In these configurations, negative analog output values are symmetrically mirrored on the Y axis. ▶ Example: mirrored output range □ 256
	12 0 ... 5 VDC (mirrored)	
	13 2 ... 10 VDC (mirrored)	
14 4 ... 20 mA (mirrored)		
15 0 ... 20 mA (mirrored)		
0x2639:002 (P440.02)	Analog output 1: Function (Analog output 1: AO1 function)	Selection of the signal to be shown at analog output 1.
	0 Not active	No output signal.
	1 Output frequency	Actual output frequency (resolution: 0.1 Hz).
	2 Frequency setpoint	Current frequency setpoint (resolution: 0.1 Hz).
	3 Analog input 1	Input signal of analog input 1 (resolution: 0.1 %).
	4 Analog input 2	Input signal of analog input 2 (resolution: 0.1 %).
	5 Motor current	Actual motor current (resolution: 0.1 A).
	6 Output power	Actual output power (resolution: 0.001 kW).
	7 Torque actual value (from version 03.00)	Current torque (resolution: 0.1 %). • 100 % = permissible maximum torque 0x6072 (P326.00)
	8 Actual motor frequency	Actual motor output frequency (resolution: 0.1 Hz).
	10 Sequencer controlled (from version 03.00)	Voltage value which has been set for the currently executed sequencer segment (resolution: 0.01 V). ▶ Sequencer □ 87
	11 DC-bus voltage	Display of the current DC-bus voltage.
	12 Device utilisation (ixt)	
	20 NetWordIN3	Actual value of the NetWordIN3 data word (resolution: 0.1 %). ▶ Control analog outputs via network □ 279
	21 NetWordIN4	Actual value of the NetWordIN4 data word (resolution: 0.1 %). ▶ Control analog outputs via network □ 279
201 Internal value (from version 05.00)	Internal values of the manufacturer.	
202 Internal value (from version 05.00)		
203 Internal value (from version 05.00)		
204 Internal value (from version 05.00)		
205 Internal value (from version 05.00)		
206 Internal value (from version 05.00)		
0x2639:003 (P440.03)	Analog output 1: Min. signal (Analog output 1: AO1 min. signal) -2147483648 ... [0] ... 2147483647	Definition of the signal value that corresponds to the minimum value at analog output 1. Example: configuration of analog output 1 as a 4 ... 20 mA current loop: output current 4 mA = 0x2639:003
0x2639:004 (P440.04)	Analog output 1: Max. signal (Analog output 1: AO1 max. signal) -2147483648 ... [1000] ... 2147483647	Definition of the signal value that corresponds to the maximum value at analog output 1. Example: configuration of analog output 1 as a 4 ... 20 mA current loop: output current 20 mA = 0x2639:004



I/O extensions and control connections

Configure analog outputs
Analog output 1

11.4.1.1 Example: Output voltage 0 ... 10 V = output frequency 0 ... 100 Hz

In this configuration, a voltage is provided at the analog output proportionately to the actual output frequency of the inverter (1 V = 10 Hz, resolution 0.1 Hz).

Parameter	Name	Setting for this example
0x2639:001 (P440.01)	Analog output 1: Output range	0 ... 10 VDC [1]
0x2639:002 (P440.02)	Analog output 1: Function	Output frequency [1]
0x2639:003 (P440.03)	Analog output 1: Min. signal	0
0x2639:004 (P440.04)	Analog output 1: Max. signal	1000

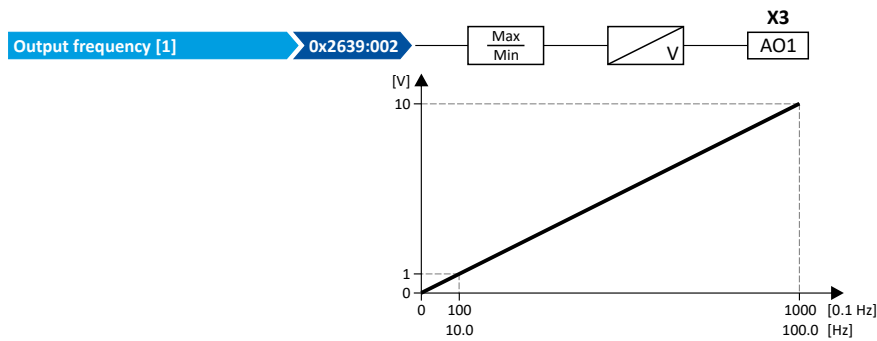

11.4.1.2 Example: Output voltage 2 ... 10 V = output frequency 30 ... 60 Hz

In this configuration, the output range 2 ... 10 V is used for the output of the output frequency (resolution: 0.1 Hz). The example shows how the signals outside the signal range (here: 30 ... 60 Hz) are cut off.

Parameter	Designation	Setting for this example
0x2639:001 (P440.01)	Analog output 1: Output range	2 ... 10 VDC [3]
0x2639:002 (P440.02)	Analog output 1: Function	Output frequency [1]
0x2639:003 (P440.03)	Analog output 1: Min. signal	300
0x2639:004 (P440.04)	Analog output 1: Max. signal	600

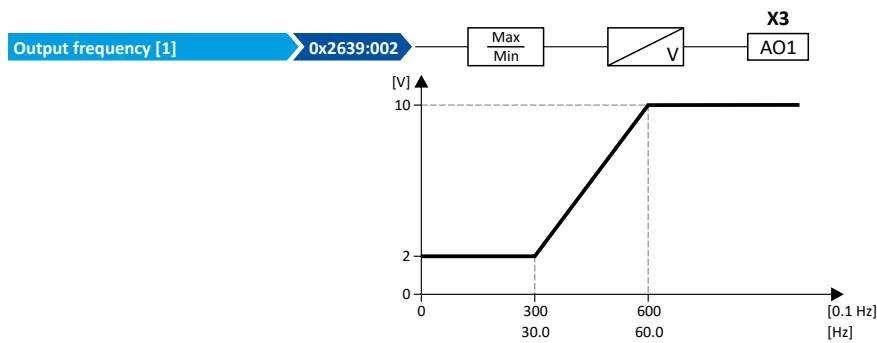

I/O extensions and control connections

Configure analog outputs
Analog output 1



11.4.1.3 Example: mirrored output range

For the definition of the output range, configurations are also available in [0x2639:001](#) ([P440.01](#)) where negative analog output values are mirrored symmetrically on the Y axis. This makes it possible to realize an absolute value generation.

The following examples illustrate the function:

Example 1: Minimum value = 0

Parameter	Name	Setting for this example
0x2639:001 (P440.01)	Analog output 1: Output range	0 ... 10 VDC (mirrored) [11]
0x2639:003 (P440.03)	Analog output 1: Min. signal	0
0x2639:004 (P440.04)	Analog output 1: Max. signal	> 0

Diagram on the left: without mirroring, diagram on the right: with mirroring of the negative output values on the Y axis

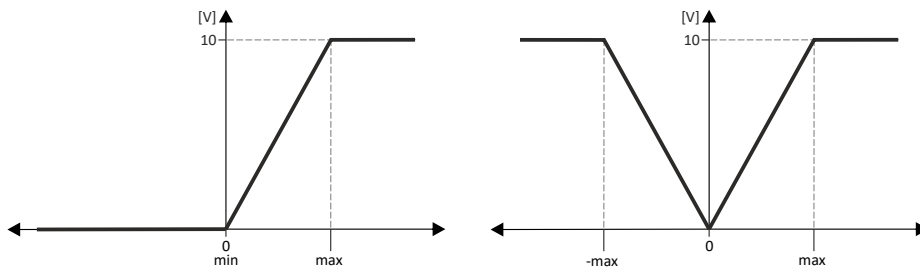

Example 2: Minimum value lower than 0

Parameter	Name	Setting for this example
0x2639:001 (P440.01)	Analog output 1: Output range	0 ... 10 VDC (mirrored) [11]
0x2639:003 (P440.03)	Analog output 1: Min. signal	< 0
0x2639:004 (P440.04)	Analog output 1: Max. signal	> 0

Diagram on the left: without mirroring, diagram on the right: with mirroring of the negative output values on the Y axis

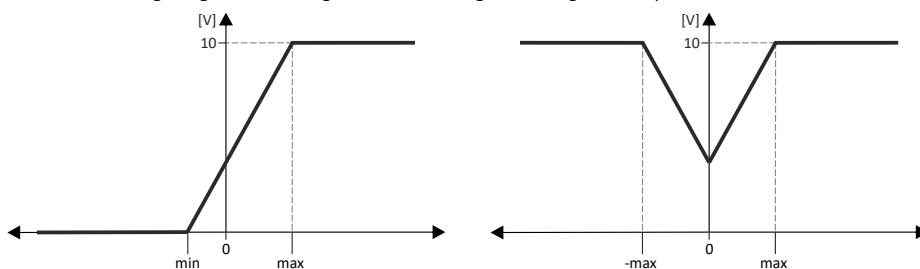

Example 3: Minimum value higher than 0

Parameter	Name	Setting for this example
0x2639:001 (P440.01)	Analog output 1: Output range	0 ... 10 VDC (mirrored) [11]
0x2639:003 (P440.03)	Analog output 1: Min. signal	> 0
0x2639:004 (P440.04)	Analog output 1: Max. signal	> Min. signal 0x2639:003 (P440.03)

Diagram on the left: without mirroring, diagram on the right: with mirroring of the negative output values on the Y axis

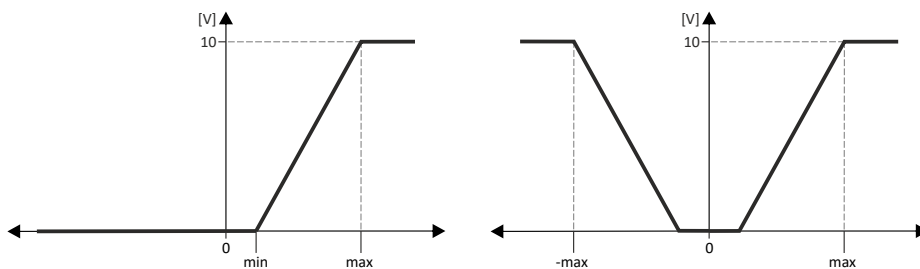



12 Configuring the network

The inverter has various basic functions for network control. The inverter also supports multiple device profiles and is available in versions with the network options CANopen® and Modbus RTU.

Basic functions for network control

- ▶ [Control the inverter via network](#) 258
- ▶ [Define setpoint via network](#) 273
- ▶ [Further mappable parameters](#) 278
- ▶ [Parameter access monitoring \(PAM\)](#) 282
- ▶ [Process data handling in the event of error](#) 283

Supported device profiles

- ▶ [CiA 402 device profile](#) 285
- ▶ [AC drive](#) 305
- ▶ [Lenze LECOM profile](#) 307

Network options

- ▶ [CANopen](#) 308
- ▶ [Modbus RTU](#) 332

Configuring the network

Control the inverter via network
Activate network control



12.1 Control the inverter via network

12.1.1 Activate network control

In order to be able to control the inverter via network, a trigger must be first assigned in [0x2631:037 \(P400.37\)](#) the "Activate network control" function.

- This trigger can for instance be the constant value "TRUE" or a digital input.
- If the assigned trigger is = TRUE, the motor can only be started via the network control word.

Exception: jog operation; see chapter "[Start, stop and rotating direction commands](#)". [49](#)

In order to control the inverter from the network, the network share [0x2631:037 \(P400.37\)](#) must be configured.

In case of an activated network control, the following functions are still active:

- [0x2631:001 \(P400.01\)](#): Inverter enable
- [0x2631:002 \(P400.02\)](#): Run
- [0x2631:003 \(P400.03\)](#): Activate quick stop
- [0x2631:004 \(P400.04\)](#): Reset error
- [0x2631:005 \(P400.05\)](#): DC braking
- [0x2631:010 \(P400.10\)](#): Jog forward (CW)
- [0x2631:011 \(P400.11\)](#): Jog reverse (CCW)*
- [0x2631:012 \(P400.12\)](#): Activate keypad control*
- [0x2631:037 \(P400.37\)](#): Activate network control*
- [0x2631:043 \(P400.43\)](#): Activate fault 1
- [0x2631:044 \(P400.44\)](#): Activate fault 2
- [0x2631:054 \(P400.54\)](#): Reset position counter

(*Not active in case of network operation in CiA402 mode 0x6060=2).

In case of an activated network control, the following functions are also still active if they are not configured in the NetWordIN1 bit functionality:

- [0x2631:048 \(P400.48\)](#): Activate PID influence ramp
- [0x2631:041 \(P400.41\)](#): Select parameter set (bit 0)
- [0x2631:042 \(P400.42\)](#): Select parameter set (bit 1)

All other functions configurable via [0x2631:xx \(P400.xx\)](#) are deactivated in case of network control.

Parameter

Address	Name / setting range / [default setting]	Information
0x2631:037 (P400.37)	Function list: Activate network control (Function list: Network control) • Further possible settings: ▶ Trigger list 59	Assignment of a trigger for the "Activate network control" function. Trigger = TRUE: Activate network control. Trigger = FALSE: no action / deactivate network control again.
	0 Not connected	No trigger assigned (trigger is constantly FALSE).
	114 Network control active (from version 02.00)	TRUE if the network control is requested via bit 5 of the AC drive control word 0x400B:001 (P592.01) . Otherwise FALSE. Notes: <ul style="list-style-type: none">• Set this selection if the network control is to be activated via bit 5 of the AC drive control word.• The AC drive control word can be used with any communication protocol. ▶ AC drive control word 305



12.1.2 Predefined control and status words

For establishing a simple network connection, the inverter provides predefined control and status words for the device profile CiA 402, the AC drive profile as well as in the LECOM format.

Details

Process data are exchanged via cyclic data exchange between the network master and the inverter.

For the cyclic data exchange, the inverter is provided with 24 network registers.

- 12 network registers are provided as input registers for data words from the network master to the inverter.
- 12 network registers are provided as output registers for data words from the inverter to the network master.
- Each network register is provided with a corresponding code that defines which parameters (or other data codes) are mapped to the network register.
- The input and output registers are divided into three blocks (A, B, C) in each case, featuring 4 successive data words, respectively:

Network register	
Input register	Output register
Network IN A0	Network OUT A0
Network IN A1	Network OUT A1
Network IN A2	Network OUT A2
Network IN A3	Network OUT A3
Network IN B0	Network OUT B0
Network IN B1	Network OUT B1
Network IN B2	Network OUT B2
Network IN B3	Network OUT B3
Network IN C0	Network OUT C0
Network IN C1	Network OUT C1
Network IN C2	Network OUT C2
Network IN C3	Network OUT C3

The terms "input" and "output" refer to the point of view of the inverter:

- Input data are transmitted by the network master and received by the inverter.
- Output data are transmitted by the inverter and received by the network master.



The assignment of the network registers and the number of data words that can be transmitted cyclically varies according to the network/communication protocol. Detailed information can be found in the documentation for the respective communication protocol.

Data mapping cannot be applied to all parameters. The mappable parameters are indicated accordingly in the "Parameter attribute list". ▶ [Parameter attribute list](#) 480

Configuring the network

Control the inverter via network
Predefined control and status words



The following table lists the predefined control and status words. These can be mapped to network registers for the cyclic exchange of data:

Name	Parameter	Associated mapping entry *	Further information
CiA control word	0x6040	0x60400010	▶ CiA 402 device profile □ 285
CiA status word	0x6041 (P780.00)	0x60410010	
AC Drive control word	0x400B:001 (P592.01)	0x400B0110	▶ AC drive □ 305
AC Drive status word	0x400C:001 (P593.01)	0x400C0110	
LECOM control word	0x400B:002 (P592.02)	0x400B0210	▶ Lenze LECOM profile □ 307
LECOM status word	0x400C:002 (P593.02)	0x400C0210	

* A mapping entry consists of index, subindex and data length in bits of the parameter to be mapped.

There are also additional mappable data words to individually control the inverter:

- ▶ [Define your own control word format](#) [□ 261](#)
- ▶ [Define your own status word format](#) [□ 269](#)
- ▶ [Further mappable parameters](#) [□ 278](#)

General information about the process of data mapping can be found in the chapter of the same name for the corresponding network.



Configuring the network

Control the inverter via network
Define your own control word format

12.1.3 Define your own control word format

The mappable data word NetWordIN1 is available for implementing a separate control word format.

Details

Designation	Parameter	Associated mapping entry *	Further information
NetWordIN1	0x4008:001 (P590.01)	0x40080110	The functions that are to be triggered via bits 0 ... 15 of the NetWordIN1 data word are defined in 0x400E:001 (P505.01) ... 0x400E:016 (P505.16) .

* A mapping entry consists of index, subindex and data length in bits of the parameter to be mapped.

General information about the process of data mapping can be found in the chapter of the same name for the corresponding network.

Configuring the network

Control the inverter via network
Define your own control word format



Parameter

Address	Name / setting range / [default setting]	Information
0x4008:001 (P590.01)	Process input words: NetWordIN1 (NetWordINx: NetWordIN1) 0x0000 ... [0x0000] ... 0xFFFF	Mappable data word for flexible control of the inverter via network.
	Bit 0 Mapping bit 0	Assignment of the function: 0x400E:001 (P505.01)
	Bit 1 Mapping bit 1	Assignment of the function: 0x400E:002 (P505.02)
	Bit 2 Mapping bit 2	Assignment of the function: 0x400E:003 (P505.03)
	Bit 3 Mapping bit 3	Assignment of the function: 0x400E:004 (P505.04)
	Bit 4 Mapping bit 4	Assignment of the function: 0x400E:005 (P505.05)
	Bit 5 Mapping bit 5	Assignment of the function: 0x400E:006 (P505.06)
	Bit 6 Mapping bit 6	Assignment of the function: 0x400E:007 (P505.07)
	Bit 7 Mapping bit 7	Assignment of the function: 0x400E:008 (P505.08)
	Bit 8 Mapping bit 8	Assignment of the function: 0x400E:009 (P505.09)
	Bit 9 Mapping bit 9	Assignment of the function: 0x400E:010 (P505.10)
	Bit 10 Mapping bit 10	Assignment of the function: 0x400E:011 (P505.11)
	Bit 11 Mapping bit 11	Assignment of the function: 0x400E:012 (P505.12)
	Bit 12 Mapping bit 12	Assignment of the function: 0x400E:013 (P505.13) Alternatively, this mapping bit can be used for controlling the digital outputs. Assignment of the digital outputs: <ul style="list-style-type: none"> Relay: 0x2634:001 (P420.01) / selection [30] Digital output 1: 0x2634:002 (P420.02) / selection [30] Note! Do not assign the mapping bit to a function and a digital output at the same time. A double assignment can cause an unpredictable drive behaviour!
	Bit 13 Mapping bit 13	Assignment of the function: 0x400E:014 (P505.14) Alternatively, this mapping bit can be used for controlling the digital outputs. Assignment of the digital outputs: <ul style="list-style-type: none"> Relay: 0x2634:001 (P420.01) / selection [31] Digital output 1: 0x2634:002 (P420.02) / selection [31] Note! Do not assign the mapping bit to a function and a digital output at the same time. A double assignment can cause an unpredictable drive behaviour!
	Bit 14 Mapping bit 14	Assignment of the function: 0x400E:015 (P505.15) Alternatively, this mapping bit can be used for controlling the digital outputs. Assignment of the digital outputs: <ul style="list-style-type: none"> Relay: 0x2634:001 (P420.01) / selection [32] Digital output 1: 0x2634:002 (P420.02) / selection [32] Note! Do not assign the mapping bit to a function and a digital output at the same time. A double assignment can cause an unpredictable drive behaviour!
Bit 15 Mapping bit 15	Assignment of the function: 0x400E:016 (P505.16) Alternatively, this mapping bit can be used for controlling the digital outputs. Assignment of the digital outputs: <ul style="list-style-type: none"> Relay: 0x2634:001 (P420.01) / selection [33] Digital output 1: 0x2634:002 (P420.02) / selection [33] Note! Do not assign the mapping bit to a function and a digital output at the same time. A double assignment can cause an unpredictable drive behaviour!	
0x400E:001 (P505.01)	NetWordIN1 function: Bit 0 (NetWordIN1 fct.: NetWordIN1.00) <ul style="list-style-type: none"> Setting can only be changed if the inverter is disabled. 	Definition of the function that is to be triggered via bit 0 of the mappable NetWordIN1 data word.
	0 Not active	Trigger bit without any function.



Configuring the network

Control the inverter via network
Define your own control word format

Address	Name / setting range / [default setting]	Information
	1 Disable inverter	<p>Trigger bit = 0-1 edge: The inverter is disabled. Trigger bit = 0: The inverter is enabled (unless there is another cause for inverter disable).</p> <p>Notes:</p> <ul style="list-style-type: none"> In all device states, a 0-1 edge causes an immediate change to the inhibited state with one exception: If the inverter is in the error status and the error condition still exists, the inverter remains in the error status. Changing to the disabled state causes an immediate stop of the motor, regardless of the stop method set in 0x2838:003 (P203.03). The motor coasts down as a function of the mass inertia of the machine. In the disabled state, the motor cannot be started. After the inverter disable is deactivated, a renewed start command is required to restart the motor. The cause(s) that are active for the disabled state are shown in 0x282A:001 (P126.01).
	2 Stopping	<p>Trigger bit = 1: Motor is stopped. Trigger bit = 0: No action / Deactivate stop again.</p> <p>Notes:</p> <ul style="list-style-type: none"> The stop method can be selected in 0x2838:003 (P203.03).
	3 Activate quick stop	<p>Trigger bit = 1: "Quick stop" function activated. Trigger bit = 0: no action / deactivate function again.</p> <p>Notes:</p> <ul style="list-style-type: none"> The "Quick stop" function brings the motor to a standstill within the deceleration time set in 0x291C (P225.00). The "Quick stop" function has a higher priority than the "Run" function.
	4 Reset error	<p>Trigger bit = 0-1 edge: Active error is reset (acknowledged) if the error condition is not active anymore and the error is resettable. Trigger bit = 0: No action.</p> <p>Notes:</p> <ul style="list-style-type: none"> After resetting the error, a new enable/start command is required to restart the motor.
	5 Activate DC braking	<p>Trigger bit = 1: "DC braking" function activated. Trigger bit = 0: no action / deactivate function again.</p> <p>▶ DC braking 190</p>
	8 Run forward (CW)	<p>Trigger bit = 0-1 edge: Motor is started in forward rotating direction (CW). Trigger bit = 1-0 edge: Motor is stopped again.</p> <p>Notes:</p> <ul style="list-style-type: none"> The stop method can be selected in 0x2838:003 (P203.03). In the case of a bipolar setpoint selection (e.g. ± 10 V), the function is executed irrespective of the rotating direction. The rotating direction is determined by the sign of the setpoint. The function also serves to realise an automatic start after switch-on. ▶ Start behavior 39 The "Reverse rotational direction [13]" function can be used in connection with this function.
	9 Run reverse (CCW)	<p>Trigger bit = 0-1 edge: Motor is started in the reverse rotating direction (CCW). Trigger bit = 1-0 edge: Motor is stopped again.</p> <p>Notes:</p> <ul style="list-style-type: none"> The stop method can be selected in 0x2838:003 (P203.03). In the case of a bipolar setpoint selection (e.g. ± 10 V), the function is executed irrespective of the rotating direction. The rotating direction is determined by the sign of the setpoint. The function also serves to realise an automatic start after switch-on. ▶ Start behavior 39 The "Reverse rotational direction [13]" function can be used in connection with this function.

Configuring the network

Control the inverter via network

Define your own control word format



Address	Name / setting range / [default setting]	Information
13	Reverse rotational direction	Trigger bit = 1: the setpoint specified is inverted (i. e. the sign is inverted). Trigger bit = 0: no action / deactivate function again.
14	Activate AI1 setpoint	Trigger bit = 1: analog input 1 is used as setpoint source (if the trigger bit assigned has the highest setpoint priority). Trigger bit = 0: no action / deactivate function again. ▶ Analog input 1 □ 240
15	Activate AI2 setpoint	Trigger bit = 1: analog input 2 is used as setpoint source (if the trigger bit assigned has the highest setpoint priority). Trigger bit = 0: no action / deactivate function again. ▶ Analog input 2 □ 244
17	Activate network setpoint	Trigger bit = 1: the network is used as setpoint source (if the trigger bit assigned has the highest setpoint priority). Trigger bit = 0: no action / deactivate function again.
18	Activate preset (bit 0)	Selection bits for bit coded selection and activation of a parameterised setpoint (preset). ▶ Setpoint presets □ 83
19	Activate preset (bit 1)	
20	Activate preset (bit 2)	
21	Activate preset (bit 3)	
26	Activate segment 1 setpoint (from version 03.00)	Selection bits for bit coded selection and activation of a parameterised segment setpoint. Notes: <ul style="list-style-type: none"> • During normal operation (no active sequence), this function serves to activate the setpoint of a segment (instead of an entire sequence in the sequencer operation). • This function is not intended for the use in the sequencer operation. ▶ Segment configuration □ 89
27	Activate segment 2 setpoint (from version 03.00)	
28	Activate segment 3 setpoint (from version 03.00)	
29	Activate segment 4 setpoint (from version 03.00)	
30	Run/abort sequence (from version 03.00)	Trigger bit = 1: Start selected sequence. Trigger bit = 0: Abort sequence. Notes: <ul style="list-style-type: none"> • The assigned trigger bit must remain set to "1" for the duration of the sequence. • If the trigger bit is reset to "0", the sequence is aborted. In this case, the standard setpoint or the setpoint source selected via setpoint change-over is active again. • A sequence is selected in a binary-coded fashion via the trigger bits assigned to the four functions "Select sequence (bit 0) [50]" ... "Select sequence (bit 3) [53]". ▶ Sequencer □ 87
32	Next sequence step (from version 03.00)	Trigger bit = 0 $\bar{1}$ (edge): Next sequence step. Trigger bit = 1 $\bar{0}$ (edge): No action. Notes: <ul style="list-style-type: none"> • The execution of the current step is completed even if the time parameterised for the segment has not elapsed yet. • The function is only relevant for Sequencer mode 0x4025 (P800.00) = "Step operation [2]" or "Time & step operation [3]". • A jump to the next sequence step is not possible if the sequence pauses, the sequence is suspended or the final segment is executed. ▶ Sequencer □ 87
33	Pause sequence (from version 03.00)	Trigger bit = 1: Pause sequence. Trigger bit = 0: Continue sequence. Notes: <ul style="list-style-type: none"> • During the pause, the sequence stops in the current step. The expiration of the time set for the segment is stopped. • The sequencer setpoint continues to remain active. ▶ Sequencer □ 87
34	Suspend sequence (from version 03.00)	Trigger bit = 1: Suspend sequence. Trigger bit = 0: Continue sequence. Notes: <ul style="list-style-type: none"> • This function serves to temporarily change over to the standard setpoint or the setpoint source selected via setpoint change-over. • The sequence is continued at the point where it was suspended. ▶ Sequencer □ 87



Configuring the network

Control the inverter via network
Define your own control word format

Address	Name / setting range / [default setting]	Information
35	Stop sequence (from version 03.00)	<p>Trigger bit = 0$\overline{1}$ (edge): Stop sequence. Trigger bit = 1$\overline{0}$ (edge): No action.</p> <p>Notes:</p> <ul style="list-style-type: none"> If the sequence is stopped, it is jumped to the final segment. The further execution depends on the selected End of sequence mode 0x402F (P824.00). <p>▶ Sequencer □ 87</p>
36	Abort sequence (from version 03.00)	<p>Trigger bit = 0$\overline{1}$ (edge): Abort sequence. Trigger bit = 1$\overline{0}$ (edge): No action.</p> <p>Notes:</p> <ul style="list-style-type: none"> This function serves to directly stop the sequence without the final segment being executed. In this case, the standard setpoint or the setpoint source selected via setpoint change-over is active again. <p>▶ Sequencer □ 87</p>
39	Activate ramp 2	<p>Trigger bit = 1: activate acceleration time 2 and deceleration time 2 manually. Trigger bit = 0: no action / deactivate function again.</p> <p>▶ Ramp times □ 80</p>
40	Load parameter set	<p>Trigger bit = 0-1 edge: parameter change-over to the value set selected via "Select parameter set (bit 0)" and "Select parameter set (bit 1)". Trigger bit = 0: no action.</p> <p>Notes:</p> <ul style="list-style-type: none"> The activation method for the "Parameter change-over" function can be selected in 0x4046 (P755.00). <p>▶ Parameter change-over □ 370</p>
41	Select parameter set (bit 0)	<p>Selection bits for the "Parameter change-over" function.</p> <p>▶ Parameter change-over □ 370</p>
42	Select parameter set (bit 1)	
43	Activate fault 1	<p>Trigger bit = 1: Trigger user-defined error 1. Trigger bit = 0: no action.</p> <p>Notes:</p> <ul style="list-style-type: none"> After the error is triggered, the motor is brought to a standstill with the quick stop ramp. The inverter is then disabled. <p>Associated error code:</p> <ul style="list-style-type: none"> 25249 0x62A1 - Network: user fault 1
44	Activate fault 2	<p>Trigger bit = 1: Trigger user-defined error 2. Trigger bit = 0: no action.</p> <p>Notes:</p> <ul style="list-style-type: none"> After the error is triggered, the motor is brought to a standstill with the quick stop ramp. The inverter is then disabled. <p>Associated error code:</p> <ul style="list-style-type: none"> 25250 0x62A2 - Network: user fault 2
45	Deactivate PID controlling	<p>Trigger bit = 1: If PID control is activated, ignore PID control and drive the motor in speed-controlled manner. Trigger bit = 0: If PID control is activated, drive the motor with PID control.</p> <p>Notes:</p> <ul style="list-style-type: none"> The PID control can be activated in 0x4020:001 (P600.01). <p>▶ Configuring the process controller □ 112</p>
46	Set PID output to 0	<p>Trigger bit = 1: If PID control is activated, I component and the output of the PID controller are set to 0 and the internal control algorithm is stopped. The PID control remains active. Trigger bit = 0: No action / deactivate function again.</p> <p>▶ Configuring the process controller □ 112</p>
47	Inhibit PID I-component	<p>Trigger bit = 1: If the PID control is activated, the I component of the PID controller is set to 0 and the integration process is stopped. Trigger bit = 0: No action / deactivate function again.</p> <p>▶ Configuring the process controller □ 112</p>

Configuring the network

Control the inverter via network
Define your own control word format



Address	Name / setting range / [default setting]	Information
	48 Activate PID influence ramp	<p>Trigger bit = 1: the influence of the process controller is shown by means of a ramp. Trigger bit = 0 or not connected: the influence of the process controller is shown by means of a ramp.</p> <p>Notes:</p> <ul style="list-style-type: none"> The influence of the process controller is always active (not only when PID control is activated). Acceleration time for showing the influence of the process controller can be set in 0x404C:001 (P607.01). Deceleration time for hiding the influence of the process controller can be set in 0x404C:002 (P607.02). <p>▶ Configuring the process controller 112</p>
	49 Release holding brake	<p>Trigger bit = 1: Release holding brake manually. Trigger bit = 0: No action.</p> <p>Notes:</p> <ul style="list-style-type: none"> The manually triggered "Release holding brake" command has a direct impact on the "Release holding brake [115]" trigger. Thus, the holding brake can be manually released if the power section is switched off. The responsibility for a manual release of the holding brake has the external trigger source for the "Release holding brake" command. <p>▶ Holding brake control 197</p>
	50 Select sequence (bit 0)	<p>Selection bits for bit coded selection of a sequence.</p> <p>Notes:</p> <ul style="list-style-type: none"> The selected sequence is not started automatically. For a status-controlled start, the function "Run/abort sequence [30]" is available. <p>▶ Sequencer control functions 106</p>
	51 Select sequence (bit 1)	
	52 Select sequence (bit 2)	
	53 Select sequence (bit 3)	
	54 Position counter reset	<p>Trigger bit = 1: Reset position counter manually. Trigger bit = 0: No action.</p> <p>▶ Position counter 383</p>
	55 Activate UPS operation	<p>Trigger bit = 1: Activate UPS operation. Trigger bit = 0: No action / deactivate function again.</p> <p>▶ Operation with UPS 391</p>
0x400E:002 (P505.02)	NetWordIN1 function: Bit 1 (NetWordIN1 fct.: NetWordIN1.01)	<p>Definition of the function that is to be triggered via bit 1 of the mappable NetWordIN1 data word.</p> <ul style="list-style-type: none"> Setting can only be changed if the inverter is disabled. For further possible settings, see parameter 0x400E:001 (P505.01). 262
	0 Not active	Trigger bit without any function.
0x400E:003 (P505.03)	NetWordIN1 function: Bit 2 (NetWordIN1 fct.: NetWordIN1.02)	<p>Definition of the function that is to be triggered via bit 2 of the mappable NetWordIN1 data word.</p> <ul style="list-style-type: none"> Setting can only be changed if the inverter is disabled. For further possible settings, see parameter 0x400E:001 (P505.01). 262
	3 Activate quick stop	<p>Trigger bit = 1: "Quick stop" function activated. Trigger bit = 0: no action / deactivate function again.</p> <p>Notes:</p> <ul style="list-style-type: none"> The "Quick stop" function brings the motor to a standstill within the deceleration time set in 0x291C (P225.00). The "Quick stop" function has a higher priority than the "Run" function.
0x400E:004 (P505.04)	NetWordIN1 function: Bit 3 (NetWordIN1 fct.: NetWordIN1.03)	<p>Definition of the function that is to be triggered via bit 3 of the mappable NetWordIN1 data word.</p> <ul style="list-style-type: none"> Setting can only be changed if the inverter is disabled. For further possible settings, see parameter 0x400E:001 (P505.01). 262
	0 Not active	Trigger bit without any function.



Configuring the network

Control the inverter via network
Define your own control word format

Address	Name / setting range / [default setting]	Information
0x400E:005 (P505.05)	NetWordIN1 function: Bit 4 (NetWordIN1 fct.: NetWordIN1.04) <ul style="list-style-type: none"> Setting can only be changed if the inverter is disabled. For further possible settings, see parameter 0x400E:001 (P505.01). □ 262 	Definition of the function that is to be triggered via bit 4 of the mappable NetWordIN1 data word.
	8 Run forward (CW)	Trigger bit = 0-1 edge: Motor is started in forward rotating direction (CW). Trigger bit = 1-0 edge: Motor is stopped again. Notes: <ul style="list-style-type: none"> The stop method can be selected in 0x2838:003 (P203.03). In the case of a bipolar setpoint selection (e.g. ±10 V), the function is executed irrespective of the rotating direction. The rotating direction is determined by the sign of the setpoint. The function also serves to realise an automatic start after switch-on. <ul style="list-style-type: none"> ▶ Start behavior □ 39 The "Reverse rotational direction [13]" function can be used in connection with this function.
0x400E:006 (P505.06)	NetWordIN1 function: Bit 5 (NetWordIN1 fct.: NetWordIN1.05) <ul style="list-style-type: none"> Setting can only be changed if the inverter is disabled. For further possible settings, see parameter 0x400E:001 (P505.01). □ 262 	Definition of the function that is to be triggered via bit 5 of the mappable NetWordIN1 data word.
	18 Activate preset (bit 0)	Selection bits for bit coded selection and activation of a parameterised setpoint (preset). ▶ Setpoint presets □ 83
0x400E:007 (P505.07)	NetWordIN1 function: Bit 6 (NetWordIN1 fct.: NetWordIN1.06) <ul style="list-style-type: none"> Setting can only be changed if the inverter is disabled. For further possible settings, see parameter 0x400E:001 (P505.01). □ 262 	Definition of the function that is to be triggered via bit 6 of the mappable NetWordIN1 data word.
	19 Activate preset (bit 1)	Selection bits for bit coded selection and activation of a parameterised setpoint (preset). ▶ Setpoint presets □ 83
0x400E:008 (P505.08)	NetWordIN1 function: Bit 7 (NetWordIN1 fct.: NetWordIN1.07) <ul style="list-style-type: none"> Setting can only be changed if the inverter is disabled. For further possible settings, see parameter 0x400E:001 (P505.01). □ 262 	Definition of the function that is to be triggered via bit 7 of the mappable NetWordIN1 data word.
	4 Reset error	Trigger bit = 0-1 edge: Active error is reset (acknowledged) if the error condition is not active anymore and the error is resettable. Trigger bit = 0: No action. Notes: <ul style="list-style-type: none"> After resetting the error, a new enable/start command is required to restart the motor.
0x400E:009 (P505.09)	NetWordIN1 function: Bit 8 (NetWordIN1 fct.: NetWordIN1.08) <ul style="list-style-type: none"> Setting can only be changed if the inverter is disabled. For further possible settings, see parameter 0x400E:001 (P505.01). □ 262 	Definition of the function that is to be triggered via bit 8 of the mappable NetWordIN1 data word.
	0 Not active	Trigger bit without any function.

Configuring the network

Control the inverter via network
Define your own control word format



Address	Name / setting range / [default setting]	Information
0x400E:010 (P505.10)	NetWordIN1 function: Bit 9 (NetWordIN1 fct.: NetWordIN1.09) <ul style="list-style-type: none"> Setting can only be changed if the inverter is disabled. For further possible settings, see parameter 0x400E:001 (P505.01). □ 262 	Definition of the function that is to be triggered via bit 9 of the mappable NetWordIN1 data word.
	5 Activate DC braking	Trigger bit = 1: "DC braking" function activated. Trigger bit = 0: no action / deactivate function again. ▶ DC braking □ 190
0x400E:011 (P505.11)	NetWordIN1 function: Bit 10 (NetWordIN1 fct.: NetWordIN1.10) <ul style="list-style-type: none"> Setting can only be changed if the inverter is disabled. For further possible settings, see parameter 0x400E:001 (P505.01). □ 262 	Definition of the function that is to be triggered via bit 10 of the mappable NetWordIN1 data word.
	0 Not active	Trigger bit without any function.
0x400E:012 (P505.12)	NetWordIN1 function: Bit 11 (NetWordIN1 fct.: NetWordIN1.11) <ul style="list-style-type: none"> Setting can only be changed if the inverter is disabled. For further possible settings, see parameter 0x400E:001 (P505.01). □ 262 	Definition of the function that is to be triggered via bit 11 of the mappable NetWordIN1 data word.
	0 Not active	Trigger bit without any function.
0x400E:013 (P505.13)	NetWordIN1 function: Bit 12 (NetWordIN1 fct.: NetWordIN1.12) <ul style="list-style-type: none"> Setting can only be changed if the inverter is disabled. For further possible settings, see parameter 0x400E:001 (P505.01). □ 262 	Definition of the function that is to be triggered via bit 12 of the mappable NetWordIN1 data word.
	13 Reverse rotational direction	Trigger bit = 1: the setpoint specified is inverted (i. e. the sign is inverted). Trigger bit = 0: no action / deactivate function again.
0x400E:014 (P505.14)	NetWordIN1 function: Bit 13 (NetWordIN1 fct.: NetWordIN1.13) <ul style="list-style-type: none"> Setting can only be changed if the inverter is disabled. For further possible settings, see parameter 0x400E:001 (P505.01). □ 262 	Definition of the function that is to be triggered via bit 13 of the mappable NetWordIN1 data word.
	0 Not active	Trigger bit without any function.
0x400E:015 (P505.15)	NetWordIN1 function: Bit 14 (NetWordIN1 fct.: NetWordIN1.14) <ul style="list-style-type: none"> Setting can only be changed if the inverter is disabled. For further possible settings, see parameter 0x400E:001 (P505.01). □ 262 	Definition of the function that is to be triggered via bit 14 of the mappable NetWordIN1 data word.
	0 Not active	Trigger bit without any function.
0x400E:016 (P505.16)	NetWordIN1 function: Bit 15 (NetWordIN1 fct.: NetWordIN1.15) <ul style="list-style-type: none"> Setting can only be changed if the inverter is disabled. For further possible settings, see parameter 0x400E:001 (P505.01). □ 262 	Definition of the function that is to be triggered via bit 15 of the mappable NetWordIN1 data word.
	0 Not active	Trigger bit without any function.

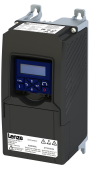

12.1.4 Define your own status word format

The mappable data word NetWordOUT1 is available for implementing a separate status word format.

Details

Designation	Parameter	Associated mapping entry *	Further information
NetWordOUT1	0x400A:001 (P591.01)	0x400A0110	The triggers for bits 0 ... 15 of the NetWordOUT1 data word are defined in 0x2634:010 (P420.10) ... 0x2634:025 (P420.25).
* A mapping entry consists of index, subindex and data length in bits of the parameter to be mapped.			

General information about the process of data mapping can be found in the chapter of the same name for the corresponding network.

Parameter

Address	Name / setting range / [default setting]	Information
0x2634:010 (P420.10)	Digital outputs function: NetWordOUT1 - bit 0 (Dig.out.function: NetWordOUT1.00) • For further possible settings, see parameter 0x2634:001 (P420.01) . 247	Assignment of a trigger to bit 0 of NetWordOUT1. Trigger = FALSE: bit set to 0. Trigger = TRUE: bit set to 1.
	51 Ready for operation	TRUE, wenn Inverter betriebsbereit (kein Fehler aktiv und Zwischenkreisspannung ok). Sonst FALSE.
0x2634:011 (P420.11)	Digital outputs function: NetWordOUT1 - bit 1 (Dig.out.function: NetWordOUT1.01) • For further possible settings, see parameter 0x2634:001 (P420.01) . 247	Assignment of a trigger to bit 1 of NetWordOUT1. Trigger = FALSE: bit set to 0. Trigger = TRUE: bit set to 1.
	0 Not connected	No trigger assigned (trigger is constantly FALSE).
0x2634:012 (P420.12)	Digital outputs function: NetWordOUT1 - bit 2 (Dig.out.function: NetWordOUT1.02) • For further possible settings, see parameter 0x2634:001 (P420.01) . 247	Assignment of a trigger to bit 2 of NetWordOUT1. Trigger = FALSE: bit set to 0. Trigger = TRUE: bit set to 1.
	52 Operation enabled	TRUE if inverter and start are enabled. Otherwise FALSE.
0x2634:013 (P420.13)	Digital outputs function: NetWordOUT1 - bit 3 (Dig.out.function: NetWordOUT1.03) • For further possible settings, see parameter 0x2634:001 (P420.01) . 247	Assignment of a trigger to bit 3 of NetWordOUT1. Trigger = FALSE: bit set to 0. Trigger = TRUE: bit set to 1.
	56 Fault active	TRUE if error is active. Otherwise FALSE.
0x2634:014 (P420.14)	Digital outputs function: NetWordOUT1 - bit 4 (Dig.out.function: NetWordOUT1.04) • For further possible settings, see parameter 0x2634:001 (P420.01) . 247	Assignment of a trigger to bit 4 of NetWordOUT1. Trigger = FALSE: bit set to 0. Trigger = TRUE: bit set to 1.
	0 Not connected	No trigger assigned (trigger is constantly FALSE).
0x2634:015 (P420.15)	Digital outputs function: NetWordOUT1 - bit 5 (Dig.out.function: NetWordOUT1.05) • For further possible settings, see parameter 0x2634:001 (P420.01) . 247	Assignment of a trigger to bit 5 of NetWordOUT1. Trigger = FALSE: bit set to 0. Trigger = TRUE: bit set to 1.
	54 Quick stop active	TRUE if quick stop is active. Otherwise FALSE.
0x2634:016 (P420.16)	Digital outputs function: NetWordOUT1 - bit 6 (Dig.out.function: NetWordOUT1.06) • For further possible settings, see parameter 0x2634:001 (P420.01) . 247	Assignment of a trigger to bit 6 of NetWordOUT1. Trigger = FALSE: bit set to 0. Trigger = TRUE: bit set to 1.
	50 Running	TRUE if inverter and start are enabled and output frequency > 0 Hz. Otherwise FALSE. Exception, quick stop mode: TRUE if inverter and start are enabled and output frequency > 0.2 Hz. Otherwise FALSE.
0x2634:017 (P420.17)	Digital outputs function: NetWordOUT1 - bit 7 (Dig.out.function: NetWordOUT1.07) • For further possible settings, see parameter 0x2634:001 (P420.01) . 247	Assignment of a trigger to bit 7 of NetWordOUT1. Trigger = FALSE: bit set to 0. Trigger = TRUE: bit set to 1.
	58 Device warning active	TRUE if warning is active. Otherwise FALSE. • A warning has no impact on the operating status of the inverter. • A warning is reset automatically if the cause has been eliminated.

Configuring the network

Control the inverter via network
Define your own status word format



Address	Name / setting range / [default setting]	Information
0x2634:018 (P420.18)	Digital outputs function: NetWordOUT1 - bit 8 (Dig.out.function: NetWordOUT1.08) • For further possible settings, see parameter 0x2634:001 (P420.01) . □ 247	Assignment of a trigger to bit 8 of NetWordOUT1. Trigger = FALSE: bit set to 0. Trigger = TRUE: bit set to 1.
	0 Not connected	No trigger assigned (trigger is constantly FALSE).
0x2634:019 (P420.19)	Digital outputs function: NetWordOUT1 - bit 9 (Dig.out.function: NetWordOUT1.09) • For further possible settings, see parameter 0x2634:001 (P420.01) . □ 247	Assignment of a trigger to bit 9 of NetWordOUT1. Trigger = FALSE: bit set to 0. Trigger = TRUE: bit set to 1.
	0 Not connected	No trigger assigned (trigger is constantly FALSE).
0x2634:020 (P420.20)	Digital outputs function: NetWordOUT1 - bit 10 (Dig.out.function: NetWordOUT1.10) • For further possible settings, see parameter 0x2634:001 (P420.01) . □ 247	Assignment of a trigger to bit 10 of NetWordOUT1. Trigger = FALSE: bit set to 0. Trigger = TRUE: bit set to 1.
	72 Setpoint speed reached	TRUE if frequency setpoint reached. Otherwise FALSE.
0x2634:021 (P420.21)	Digital outputs function: NetWordOUT1 - bit 11 (Dig.out.function: NetWordOUT1.11) • For further possible settings, see parameter 0x2634:001 (P420.01) . □ 247	Assignment of a trigger to bit 11 of NetWordOUT1. Trigger = FALSE: bit set to 0. Trigger = TRUE: bit set to 1.
	78 Current limit reached	TRUE if current motor current \geq maximum current. Otherwise FALSE. • Display of the present motor current in 0x2D88 (P104.00) . • Setting for the maximum current in 0x6073 (P324.00) .
0x2634:022 (P420.22)	Digital outputs function: NetWordOUT1 - bit 12 (Dig.out.function: NetWordOUT1.12) • For further possible settings, see parameter 0x2634:001 (P420.01) . □ 247	Assignment of a trigger to bit 12 of NetWordOUT1. Trigger = FALSE: bit set to 0. Trigger = TRUE: bit set to 1.
	71 Actual speed = 0	TRUE if actual output frequency = 0 Hz (\pm 0.3 Hz), irrespective of the operating mode. Otherwise FALSE. • Display of the current output frequency in 0x2DDD (P100.00) .
0x2634:023 (P420.23)	Digital outputs function: NetWordOUT1 - bit 13 (Dig.out.function: NetWordOUT1.13) • For further possible settings, see parameter 0x2634:001 (P420.01) . □ 247	Assignment of a trigger to bit 13 of NetWordOUT1. Trigger = FALSE: bit set to 0. Trigger = TRUE: bit set to 1.
	69 Rotational direction reversed	TRUE if output frequency is negative. Otherwise FALSE.
0x2634:024 (P420.24)	Digital outputs function: NetWordOUT1 - bit 14 (Dig.out.function: NetWordOUT1.14) • For further possible settings, see parameter 0x2634:001 (P420.01) . □ 247	Assignment of a trigger to bit 14 of NetWordOUT1. Trigger = FALSE: bit set to 0. Trigger = TRUE: bit set to 1.
	115 Release holding brake	Trigger signal for releasing the holding brake (TRUE = release holding brake). Note! If this trigger is assigned to the relay or a digital output, the deceleration times set for the respective output are not effective (are internally set to "0"). Only the deceleration time set in 0x2820:012 (P712.12) for closing the holding brake influences in this case the time-dependent behaviour of the output. ▶ Holding brake control □ 197
0x2634:025 (P420.25)	Digital outputs function: NetWordOUT1 - bit 15 (Dig.out.function: NetWordOUT1.15) • For further possible settings, see parameter 0x2634:001 (P420.01) . □ 247	Assignment of a trigger to bit 15 of NetWordOUT1. Trigger = FALSE: bit set to 0. Trigger = TRUE: bit set to 1.
	55 Inverter disabled (safety)	Function is not supported in this device.
0x2635:010	Inversion of digital outputs: NetWordOUT1.00	Inversion of bit 0 of NetWordOUT1.
	0 Not inverted 1 Inverted	
0x2635:011	Inversion of digital outputs: NetWordOUT1.01	Inversion of bit 1 of NetWordOUT1.
	0 Not inverted 1 Inverted	
0x2635:012	Inversion of digital outputs: NetWordOUT1.02	Inversion of bit 2 of NetWordOUT1.
	0 Not inverted 1 Inverted	



Configuring the network

Control the inverter via network
Define your own status word format

Address	Name / setting range / [default setting]	Information
0x2635:013	Inversion of digital outputs: NetWordOUT1.03	Inversion of bit 3 of NetWordOUT1.
	0 Not inverted	
	1 Inverted	
0x2635:014	Inversion of digital outputs: NetWordOUT1.04	Inversion of bit 4 of NetWordOUT1.
	0 Not inverted	
	1 Inverted	
0x2635:015	Inversion of digital outputs: NetWordOUT1.05	Inversion of bit 5 of NetWordOUT1.
	0 Not inverted	
	1 Inverted	
0x2635:016	Inversion of digital outputs: NetWordOUT1.06	Inversion of bit 6 of NetWordOUT1.
	0 Not inverted	
	1 Inverted	
0x2635:017	Inversion of digital outputs: NetWordOUT1.07	Inversion of bit 7 of NetWordOUT1.
	0 Not inverted	
	1 Inverted	
0x2635:018	Inversion of digital outputs: NetWordOUT1.08	Inversion of bit 8 of NetWordOUT1.
	0 Not inverted	
	1 Inverted	
0x2635:019	Inversion of digital outputs: NetWordOUT1.09	Inversion of bit 9 of NetWordOUT1.
	0 Not inverted	
	1 Inverted	
0x2635:020	Inversion of digital outputs: NetWordOUT1.10	Inversion of bit 10 of NetWordOUT1.
	0 Not inverted	
	1 Inverted	
0x2635:021	Inversion of digital outputs: NetWordOUT1.11	Inversion of bit 11 of NetWordOUT1.
	0 Not inverted	
	1 Inverted	
0x2635:022	Inversion of digital outputs: NetWordOUT1.12	Inversion of bit 12 of NetWordOUT1.
	0 Not inverted	
	1 Inverted	
0x2635:023	Inversion of digital outputs: NetWordOUT1.13	Inversion of bit 13 of NetWordOUT1.
	0 Not inverted	
	1 Inverted	
0x2635:024	Inversion of digital outputs: NetWordOUT1.14	Inversion of bit 14 of NetWordOUT1.
	0 Not inverted	
	1 Inverted	
0x2635:025	Inversion of digital outputs: NetWordOUT1.15	Inversion of bit 15 of NetWordOUT1.
	0 Not inverted	
	1 Inverted	

Configuring the network

Control the inverter via network
Define your own status word format



Address	Name / setting range / [default setting]	Information
0x400A:001 (P591.01)	Process output words: NetWordOUT1 (NetWordOUTx: NetWordOUT1) • Read only	Mappable data word for the output of status messages of the inverter via network.
Bit 0	Mapping bit 0	Mappable data word for the output of status messages of the inverter via network. Assignment of the status message: 0x2634:010 (P420.10)
Bit 1	Mapping bit 1	Mappable data word for the output of status messages of the inverter via network. Assignment of the status message: 0x2634:011 (P420.11)
Bit 2	Mapping bit 2	Mappable data word for the output of status messages of the inverter via network. Assignment of the status message: 0x2634:012 (P420.12)
Bit 3	Mapping bit 3	Mappable data word for the output of status messages of the inverter via network. Assignment of the status message: 0x2634:013 (P420.13)
Bit 4	Mapping bit 4	Mappable data word for the output of status messages of the inverter via network. Assignment of the status message: 0x2634:014 (P420.14)
Bit 5	Mapping bit 5	Mappable data word for the output of status messages of the inverter via network. Assignment of the status message: 0x2634:015 (P420.15)
Bit 6	Mapping bit 6	Mappable data word for the output of status messages of the inverter via network. Assignment of the status message: 0x2634:016 (P420.16)
Bit 7	Mapping bit 7	Mappable data word for the output of status messages of the inverter via network. Assignment of the status message: 0x2634:017 (P420.17)
Bit 8	Mapping bit 8	Mappable data word for the output of status messages of the inverter via network. Assignment of the status message: 0x2634:018 (P420.18)
Bit 9	Mapping bit 9	Mappable data word for the output of status messages of the inverter via network. Assignment of the status message: 0x2634:019 (P420.19)
Bit 10	Mapping bit 10	Mappable data word for the output of status messages of the inverter via network. Assignment of the status message: 0x2634:020 (P420.20)
Bit 11	Mapping bit 11	Mappable data word for the output of status messages of the inverter via network. Assignment of the status message: 0x2634:021 (P420.21)
Bit 12	Mapping bit 12	Mappable data word for the output of status messages of the inverter via network. Assignment of the status message: 0x2634:022 (P420.22)
Bit 13	Mapping bit 13	Mappable data word for the output of status messages of the inverter via network. Assignment of the status message: 0x2634:023 (P420.23)
Bit 14	Mapping bit 14	Mappable data word for the output of status messages of the inverter via network. Assignment of the status message: 0x2634:024 (P420.24)
Bit 15	Mapping bit 15	Mappable data word for the output of status messages of the inverter via network. Assignment of the status message: 0x2634:025 (P420.25)



12.2 Define setpoint via network

The network setpoint must be explicitly selected if the setpoint is to be specified via the network.

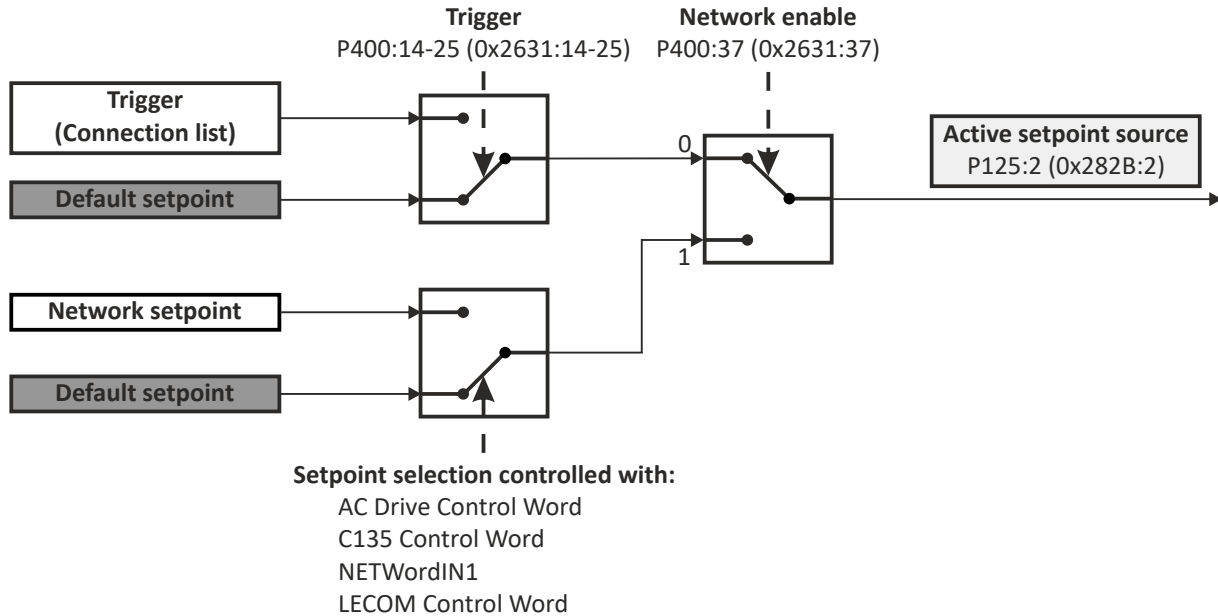

▶ [Option 1: Define network as standard setpoint source](#) [274](#)

▶ [Option 2: Change over to the network setpoint during operation](#) [275](#)

Mappable parameters

The following mappable parameters are available, among others, for specifying the setpoint.

- The parameters are always available irrespective of the network option.
- Additional mappable parameters with different resolutions are available for selection to transfer the frequency setpoint and actual frequency value. ▶ [Mappable parameters for exchanging setpoints and actual values](#) [276](#)

Parameter

Address	Name / setting range / [default setting]	Information
0x400B:006 (P592.06)	Process input data: Velocity mode setpoint (Process data IN: Veloc. mode setp) -599.0 ... [0.0] ... 599.0 Hz	Mappable parameter for defining the setpoint for operating mode "MS: Velocity mode" via network. <ul style="list-style-type: none"> • If this parameter is to be used as standard setpoint source, the selection "Network [5]" must be set in 0x2860:001 (P201.01). • If this bipolar setpoint is used, the direction of rotation cannot be controlled via the network control word. The direction of rotation is determined by the sign of the setpoint.
0x400B:007 (P592.07)	Process input data: PID setpoint (Process data IN: PID setpoint) -300.00 ... [0.00] ... 300.00 PID unit	Mappable parameter for defining the setpoint for the PID control via network. <ul style="list-style-type: none"> • If this parameter is to be used as standard setpoint source, the selection "Network [5]" must be set in 0x2860:002 (P201.02).
0x400B:008 (P592.08)	Process input data: Torque mode setpoint (Process data IN: Torque mode setp) -32768 ... [0] ... 32767 Nm	Mappable parameter for defining the setpoint for operating mode "MS: Torque mode" via network. <ul style="list-style-type: none"> • If this parameter is to be used as standard setpoint source, the selection "Network [5]" must be set in 0x2860:003 (P201.03). • The scaling factor can be set in 0x400B:009 (P592.09). • Scaled torque setpoint = torque setpoint (0x400B:008) / 2^{scaling factor} <p>Example:</p> <ul style="list-style-type: none"> • Torque setpoint (0x400B:008) = 345 [Nm] • Scaling factor (0x400B:009) = 3 • Scaled torque setpoint = 345 [Nm] / 2³ = 43.125 [Nm]

Configuring the network

Define setpoint via network

Option 1: Define network as standard setpoint source



12.2.1 Option 1: Define network as standard setpoint source

If the setpoint is to be specified exclusively via the network, the network for the corresponding control can be simply set as the standard setpoint source.

- Setting for the frequency control: **0x2860:001 (P201.01)** = "Network [5]".
- See the following table for settings for additional controls.

Control: size	Parameter	Setting	Further information
Frequency control: frequency setpoint	0x2860:001 (P201.01)	Network [5]	Frequency control ▶ Standard setpoint source 78
PID control: reference value	0x2860:002 (P201.02)	Network [5]	Frequency control ▶ Configuring the process controller 112
PID control: feedback of the control variable (actual value)	0x4020:002 (P600.02)	Network [5]	
PID control: speed feedforward control	0x4020:004 (P600.04)	Network [8]	
Torque control: torque setpoint	0x2860:003 (P201.03)	Network [5]	Torque control ▶ Standard setpoint source 148



12.2.2 Option 2: Change over to the network setpoint during operation

There are several options for change-over to the network setpoint.

Example 1: Independent of the network used, a change-over from the standard setpoint source to the network setpoint is to be possible via a digital trigger (e. g. digital input).

1. Set a standard setpoint source different than "Network [5]" in [0x2860:001 \(P201.01\)](#).
2. Set the desired digital trigger (e. g. digital input) in via which the change-over to the network setpoint is to take place.

The current setpoint source is shown in [0x282B:002 \(P125.02\)](#).



The setpoint change-over by means of the network control words is only possible if the controller is activated via the network [0x2631:037 \(P400.37\)](#).

The following table describes the change-over to the network setpoint via the different network control words:

Network control word	Change-over to network setpoint		
NetWordIN1 data word 0x4008:001 (P590.01)	Assign the function "Activate network setpoint [17]" to the bit that is to be used for activating the network setpoint.		
	<ul style="list-style-type: none"> • The functions that are to be triggered via bits 0 ... 15 of the NetWordIN1 data word are defined in 0x400E:001 (P505.01) ... 0x400E:016 (P505.16). 		
	Bit x	Selection:	
	0	Standard setpoint source selected in 0x2860:001 (P201.01) .	
	1	Network setpoint	
AC drive control word 0x400B:001 (P592.01)	The network setpoint is activated via bit 6 of the AC Drive control word:		
	Bit 6	Selection:	
	0	Standard setpoint source selected in 0x2860:001 (P201.01) .	
	1	Network setpoint	
In order that the activation via bit 6 works, "Activate network control" bit 5 must be TRUE. (Standard)! If control is to be initiated via bit 6 without "Activate network control" bit 5, the selection "Network setpoint active [116]" must be set in 0x2631:017 (P400.17) .			
LECOM control word 0x400B:002 (P592.02)	The setpoint is selected via bit 0 and bit 1 of the LECOM control word:		
	Bit 1	Bit 0	Selection:
	0	0	Standard setpoint source selected in 0x2860:001 (P201.01) .
	0	1	Frequency setpoint preset 1 0x2911:001 (P450.01)
	1	0	Frequency setpoint preset 2 0x2911:002 (P450.02)
	1	1	Frequency setpoint preset 3 0x2911:002 (P450.02)
CiA control word 0x6040	In case of control via the device profile CiA 402:		
	<ul style="list-style-type: none"> • In operating mode "CiA: Velocity mode [2]", the setpoint speed defined via the "Set speed" 0x6042 (P781.00) parameter is used. • A changeover to an alternative setpoint source via the CiA control word is not possible. 		

Configuring the network

Define setpoint via network

Mappable parameters for exchanging setpoints and actual values



12.2.3 Mappable parameters for exchanging setpoints and actual values

The parameters listed in the following can also be mapped to network registers, in order to transfer set points and actual values via the network.

- The parameters are always available irrespective of the network option.
- Several parameters with different resolutions are available for selection to transfer the frequency setpoint and actual value.
- The use of these parameters for the transmission of process data is optional. It is also possible to use only a selection of the parameters.

Parameter

Address	Name / setting range / [default setting]	Information
0x400B:003 (P592.03)	Process input data: Network setpoint frequency (0.1) (Process data IN: Net.freq. 0.1) 0.0 ... [0.0] ... 599.0 Hz	Mappable parameter for specifying the frequency setpoint in [0.1 Hz] via network. <ul style="list-style-type: none"> • The specification is made without sign (irrespective of the rotating direction). • The rotating direction is specified via the control word. • Example: 456 = 45.6 Hz
0x400B:004 (P592.04)	Process input data: Network setpoint speed (Process data IN: Net.setp. speed) 0 ... [0] ... 50000 rpm	Mappable parameter for specifying the setpoint as speed in [rpm] via network. <ul style="list-style-type: none"> • The specification is made without sign (irrespective of the rotating direction). • The rotating direction is specified via the control word. • Example: 456 = 456 rpm
0x400B:005 (P592.05)	Process input data: Network setpoint frequency (0.01) (Process data IN: Net.freq. 0.01) 0.00 ... [0.00] ... 599.00 Hz	Mappable parameter for specifying the frequency setpoint in [0.01 Hz] via network. <ul style="list-style-type: none"> • The specification is made without sign (irrespective of the rotating direction). • The rotating direction is specified via the control word. • Example: 456 = 4.56 Hz
0x400B:009 (P592.09)	Process input data: Torque scaling (Process data IN: Torque scaling) -128 ... [0] ... 127 <ul style="list-style-type: none"> • From version 02.00 	Scaling factor for torque setpoint 0x400B:008 (P592.08) and actual torque value 0x400C:007 (P593.07) via network. <ul style="list-style-type: none"> • With the setting 0, no scaling takes place. Example: <ul style="list-style-type: none"> • Scaled actual torque value (0x400C:007) = 345 [Nm] • Scaling factor (0x400B:009) = 3 • Actual torque value = 345 [Nm] / 23 = 43.125 [Nm]
0x400B:012 (P592.12)	Process input data: Network setpoint frequency [0.02Hz] (Process data IN: NetSetfreq0.02Hz) -29950 ... [0] ... 29950 Hz <ul style="list-style-type: none"> • From version 04.00 	Mappable parameter for specifying the frequency setpoint in [0.02 Hz] via network. <ul style="list-style-type: none"> • The specification is made without sign (irrespective of the rotating direction). • The rotating direction is specified via the control word. • Examples: 50 = 1 Hz, 100 = 2 Hz
0x400B:013 (P592.13)	Process input data: Network frequency setpoint [+/-16384] (Process data IN: N.FrqSet+/-16384) -16384 ... [0] ... 16384 <ul style="list-style-type: none"> • From version 05.00 	Mappable parameter for specifying the frequency setpoint via network. <ul style="list-style-type: none"> • $\pm 16384 = \pm 100\%$ Maximum frequency 0x2916 (P211.00)
0x400C:003 (P593.03)	Process output data: Frequency (0.1) (Process data OUT: Frequency (0.1)) <ul style="list-style-type: none"> • Read only: x.x Hz 	Mappable parameter for the output of the actual frequency value in [0.1 Hz] via network. <ul style="list-style-type: none"> • The output is effected without sign (irrespective of the rotating direction). • The rotating direction is specified via the status word. • Example: 456 = 45.6 Hz
0x400C:004 (P593.04)	Process output data: Motor speed (Process data OUT: Motor speed) <ul style="list-style-type: none"> • Read only: x rpm 	Mappable parameter for the output of the actual value as speed in [rpm] via network. <ul style="list-style-type: none"> • The output is made without sign (irrespective of the rotating direction). • The rotating direction is specified via the status word. • Example: 456 = 456 rpm
0x400C:006 (P593.06)	Process output data: Frequency (0.01) (Process data OUT: Frequency 0.01) <ul style="list-style-type: none"> • Read only: x.xx Hz 	Mappable parameter for the output of the actual frequency value in [0.01 Hz] via network. <ul style="list-style-type: none"> • The output is made without sign (irrespective of the rotating direction). • The rotating direction is specified via the status word. • Example: 456 = 4.56 Hz



Configuring the network

Define setpoint via network

Mappable parameters for exchanging setpoints and actual values

Address	Name / setting range / [default setting]	Information
0x400C:007 (P593.07)	Process output data: Torque scaled (Process data OUT: Torque scaled) <ul style="list-style-type: none"> • Read only • From version 02.00 	Mappable parameter for the output of the actual torque value in [Nm / $2^{\text{scaling factor}}$] via network. <ul style="list-style-type: none"> • The scaling factor can be set in 0x400B:009 (P592.09). • Actual torque value = scaled actual torque value (0x400C:007) / $2^{\text{scaling factor}}$ <p>Example:</p> <ul style="list-style-type: none"> • Scaled actual torque value (0x400C:007) = 345 [Nm] • Scaling factor (0x400B:009) = 3 • Actual torque value = 345 [Nm] / $2^3 = 43.125$ [Nm]
0x400C:008 (P593.08)	Process output data: Frequency [0.02 Hz] (Process data OUT: Frequency 0.02Hz) <ul style="list-style-type: none"> • Read only: Hz • From version 04.00 	Mappable parameter for the output of the actual frequency value in [0.02 Hz] via network. <ul style="list-style-type: none"> • The output is effected without sign (irrespective of the rotating direction). • The rotating direction is specified via the status word. • Examples: 50 = 1 Hz, 100 = 2 Hz
0x400C:009 (P593.09)	Process output data: Frequency [±16384] (Process data OUT: Freq. [±16384]) <ul style="list-style-type: none"> • Read only • From version 05.00 	Mappable parameter for the output of the actual frequency value via network. <ul style="list-style-type: none"> • $\pm 16384 = \pm 100\%$ Maximum frequency 0x2916 (P211.00)



12.3 Further mappable parameters

The parameters listed in the following can also be mapped to network registers to transmit, for example, control and status information as process data or to control outputs of the inverter via the network.

- The parameters are always available irrespective of the network option.
- The use of these parameters for the transmission of process data is optional. It is also possible to use only a selection of the parameters.

Process input data

Address	Designation	Info
0x400B:011 (P592.11)	Process input data: PID feedback	▶ Feedback of PID variable via network □ 279
0x4008:002 (P590.02)	Process input words: NetWordIN2	▶ Control digital outputs via network □ 279
0x4008:003 (P590.03)	Process input words: NetWordIN3	▶ Control analog outputs via network □ 279
0x4008:004 (P590.04)	Process input words: NetWordIN4	
0x4008:005 (P590.05)	Process input words: NetWordIN5	▶ Additive voltage impression via network □ 280

Process output data

Address	Designation	Info
0x400C:005 (P593.05)	Process output data: Drive status	▶ Drive status □ 281
0x2C49:003 (P711.03)	Position counter: Actual position	▶ Position counter □ 383
0x400A:002 (P591.02)	Process output words: NetWordOUT2	▶ Output messages of the "sequencer" function via network □ 281



12.3.1 Process input data

12.3.1.1 Feedback of PID variable via network

The feedback of the control variable (actual value) can also be initiated via the network for the process controller. In this case, the following mappable parameter is available.

Parameter

Address	Name / setting range / [default setting]	Information
0x400B:011 (P592.11)	Process input data: PID feedback (Process data IN: PID feedback) -300.00 ... [0.00] ... 300.00 PID unit • From version 03.00	Mappable parameter for the feedback of the variable (actual value) via network. • Only effective with the selection "Network[5]" in 0x4020:002 (P600.02).

Related topics

▶ [Configuring the process controller](#) 112

12.3.1.2 Control digital outputs via network

The mappable data word NetWordIN2 is available for controlling the digital outputs via the network.

Parameter

Address	Name / setting range / [default setting]	Information
0x4008:002 (P590.02)	Process input words: NetWordIN2 (NetWordINx: NetWordIN2) 0x0000 ... [0x0000] ... 0xFFFF	Mappable data word for optional control of the digital outputs via network. Assignment of the digital outputs: • Relay: 0x2634:001 (P420.01) / selection [34] ... [49] • Digital output 1: 0x2634:002 (P420.02) / selection [34] ... [49]
	Bit 0 Mapping bit 0	
	Bit 1 Mapping bit 1	
	Bit 2 Mapping bit 2	
	Bit 3 Mapping bit 3	
	Bit 4 Mapping bit 4	
	Bit 5 Mapping bit 5	
	Bit 6 Mapping bit 6	
	Bit 7 Mapping bit 7	
	Bit 8 Mapping bit 8	
	Bit 9 Mapping bit 9	
	Bit 10 Mapping bit 10	
	Bit 11 Mapping bit 11	
	Bit 12 Mapping bit 12	
	Bit 13 Mapping bit 13	
	Bit 14 Mapping bit 14	
	Bit 15 Mapping bit 15	

Related topics

▶ [Configure digital outputs](#) 247

12.3.1.3 Control analog outputs via network

The mappable data words NetWordIN3 and NetWordIN4 are available for controlling the analog outputs via the network.

Parameter

Address	Name / setting range / [default setting]	Information
0x4008:003 (P590.03)	Process input words: NetWordIN3 (NetWordINx: NetWordIN3) 0.0 ... [0.0] ... 100.0 %	Mappable data word for optional control of an analog output via network. Assignment of the analog output: • Analog output 1: 0x2639:002 (P440.02) = "NetWordIN3 [20]"
0x4008:004 (P590.04)	Process input words: NetWordIN4 (NetWordINx: NetWordIN4) 0.0 ... [0.0] ... 100.0 %	Mappable data word for optional control of an analog output via network. Assignment of the analog output: • Analog output 1: 0x2639:002 (P440.02) = "NetWordIN4 [21]"

Related topics

▶ [Configure analog outputs](#) 253

Configuring the network

Further mappable parameters
Process input data



12.3.1.4 Additive voltage impression via network

The mappable data word NetWordIN5 is available for the optional specification of an additive voltage setpoint via the network.

Parameter

Address	Name / setting range / [default setting]	Information
0x4008:005 (P590.05)	Process input words: NetWordIN5 (NetWordINx: NetWordIN5) -100.0 ... [0.0] ... 100.0 %	Mappable data word for optionally specifying an additive voltage setpoint via network. <ul style="list-style-type: none">• 100 % = Rated voltage 0x2C01:007 (P320.07)• This value is used if "Network [3]" is selected in 0x2B13:002.

Related topics

▶ [Additive voltage impression](#)  183



12.3.2 Process output data

12.3.2.1 Drive status

The following mappable parameter is available for the output of the drive status via the network.

Parameter

Address	Name / setting range / [default setting]	Information
0x400C:005 (P593.05)	Process output data: Drive status (Process data OUT: Drive status)	Mappable status word (Modbus Legacy Register 2003).
	• Read only	
	0 Error (non-resettable) active	
	1 Fault active	
	2 Waiting for start	
	3 Identification not executed	
	4 Inverter disabled	
	5 Stop active	
	7 Identification active	
	8 Running	
	9 Acceleration active	
	10 Deceleration active	
	11 Deceleration override active	
	12 DC braking active	
	13 Flying start active	
	14 Current limit reached	
16 Process controller sleep mode		

12.3.2.2 Output messages of the "sequencer" function via network

The mappable data word NetWordOUT2 is available to output messages of the "Sequencer" function via the network.

- An individual message (16 bit value) can be configured for each sequencer segment.
 - ▶ [Segment configuration](#) 89
- The NetWordOUT2 data word is set to the value set for the execution time of the segment.

Parameter

Address	Name / setting range / [default setting]	Information
0x400A:002 (P591.02)	Process output words: NetWordOUT2 (NetWordOUTx: NetWordOUT2)	Mappable data word for the output of messages of the "Sequencer" function via network. Configuration of the messages: <ul style="list-style-type: none"> • 0x4026:008: NetWordOUT2 value for sequencer segment 1 • 0x4027:008: NetWordOUT2 value for sequencer segment 2 • 0x4028:008: NetWordOUT2 value for sequencer segment 3 • 0x4029:008: NetWordOUT2 value for sequencer segment 4 • 0x402A:008: NetWordOUT2 value for sequencer segment 5 • 0x402B:008: NetWordOUT2 value for sequencer segment 6 • 0x402C:008: NetWordOUT2 value for sequencer segment 7 • 0x402D:008: NetWordOUT2 value for sequencer segment 8 • 0x402E:008: NetWordOUT2 value for final segment
	• Read only	
	Bit 0 Mapping bit 0	
	Bit 1 Mapping bit 1	
	Bit 2 Mapping bit 2	
	Bit 3 Mapping bit 3	
	Bit 4 Mapping bit 4	
	Bit 5 Mapping bit 5	
	Bit 6 Mapping bit 6	
	Bit 7 Mapping bit 7	
	Bit 8 Mapping bit 8	
	Bit 9 Mapping bit 9	
	Bit 10 Mapping bit 10	
	Bit 11 Mapping bit 11	
	Bit 12 Mapping bit 12	
	Bit 13 Mapping bit 13	
	Bit 14 Mapping bit 14	
Bit 15 Mapping bit 15		

Related topics

- ▶ [Sequencer](#) 87



12.4 Parameter access monitoring (PAM)

The parameter access monitoring can be used as basic protection against a control loss of the inverter. Monitoring is triggered if a parameter write access to a certain index does not take place at regular intervals via the established communication connection.

Preconditions

This monitoring only works when the network control is activated.

Except for the keypad, the monitoring can be used for all communication connections, for instance:

- PC/Engineering Tool <--> inverter with USB module
- PC/Engineering Tool <--> inverter with WLAN module
- Controller <--> network <--> inverter with network option

Details

For monitoring purposes, a non-zero value must be written into the "Keep-alive register" [0x2552:002 \(P595.02\)](#) at regular intervals. The first write access with a non-zero value activates monitoring. The intervals between the write accesses must not be higher than the time-out time set in [0x2552:003 \(P595.03\)](#). If no parameter write access takes place within the time-out time, monitoring is triggered: The response selected in [0x2552:004 \(P595.04\)](#) takes place and the action selected in [0x2552:005 \(P595.05\)](#). In addition, the status bit 1 in [0x2552:006 \(P595.06\)](#) is set to "1".

The error status can be left by a normal "error reset". Since monitoring continues to be active and the time-out time is not reset by the error reset, the inverter immediately changes again to the error status. In order to prevent this, you have the following options:

- Restore communication exchange.
- Set the monitoring response in [0x2552:004 \(P595.04\)](#) to "No response [0]" or "Warning [1]".
- Change over to local or flexible control.

Parameter

Address	Name / setting range / [default setting]	Information
0x2552:002 (P595.02)	Parameter access monitoring: Keep alive register (PAM monitoring: Keep alive reg.) 0 ... [0] ... 65535 • From version 04.00	Register for cyclic parameter write accesses for monitoring the communication link. • If the setting is non-zero, the monitoring is active. • In order that the monitoring is not tripped, a non-zero value has to be entered into this index at regular intervals. The temporal distances of the write accesses must not be higher than the time-out time set in 0x2552:003 (P595.03) .
0x2552:003 (P595.03)	Parameter access monitoring: Time-out time (PAM monitoring: Time-out time) 0.0 ... [10.0] ... 6553.5 s • From version 04.00	Maximum permitted time between two write accesses to the "keep-alive-register". In case of a time-out • the error response selected in 0x2552:004 (P595.04) is effected, • the action selected in 0x2552:005 (P595.05) is effected, • the status bit 1 in 0x2552:006 (P595.06) is set to "1".
0x2552:004 (P595.04)	Parameter access monitoring: Reaction (PAM monitoring: Reaction) • From version 04.00	Selection of the response to the triggering of the parameter access monitoring. Associated error code: • 33045 0x8115 - Time-out (PAM)
	0 No response	▶ Error types 456
	1 Warning	
	2 Trouble	
	3 Fault	
0x2552:005 (P595.05)	Parameter access monitoring: Action (PAM monitoring: Action) • From version 04.00	Selection of the action to be executed if the parameter access monitoring is triggered.
	0 No action	
	1 Reserved	



Address	Name / setting range / [default setting]	Information
0x2552:006 (P595.06)	Parameter access monitoring: Parameter Access Monitoring-Status (PAM monitoring: PAM status)	Bit coded display of the status of parameter access monitoring.
	• Read only • From version 04.00	
	Bit 0 Monitoring activated	1 = parameter access monitoring is active.
	Bit 1 Timeout	1 = within the time-out time set in 0x2552:003 (P595.03), no successful parameter write access to the "keep-alive register" 0x2552:002 (P595.02) was made.
Bit 2 WLAN time-out		
0x2552:007 (P595.07)	Parameter access monitoring: WLAN reset time-out time (PAM monitoring: WLAN reset t.out) 0 ... [0] ... 65535 s • From version 05.00	Time after which the WLAN network with the current settings of the WLAN parameters is restarted if no "keep alive" messages are received. • 0 s = function deactivated (no WLAN restart). • With a setting > 0 s and a time-out, the control units sets 0x2440 = "Restart with current values [1]".

12.5 Process data handling in the event of error

Received invalid process data is not used. The inverter uses the last valid process data received. You can optionally set that the contents of the process data in the inverter are set to the value "0" after invalid process data has been received.



The setting in 0x24E5:001 is independent of the response selected in 0x2859:005 if invalid process data has been received!

If the application requires that the drive keeps moving with the last valid process data when receiving invalid process data, set the response "No response" or "Warning" in 0x2859:005. In addition, the selection "Clear data [1]" must not be set in 0x24E5:001. Deleting the process data would stop the motor.

Parameter

Address	Name / setting range / [default setting]	Information
0x24E5:001	Process data handling in case of error: Procedure	Selection which process data the inverter is to use after receiving invalid process data.
	0 Keep last data	The last valid process data of the master are used.
	1 Clear data	The contents of the process data in the inverter is set to the value "0".
	2 Reset control word (from version 05.04)	The RUN command is reset. All other parameters keep their current value.

Configuring the network

Suppress certain alarm / emergency messages to the master



12.6 Suppress certain alarm / emergency messages to the master

To simplify the error handling between a master and the inverter, a function for suppressing diagnostic or alarm messages is implemented. If desired, the user can suppress the display of alarm responses in the master.

Usually, all errors occurring in the device are reported to a connected PLC if an alarm / emergency mechanism with the connected communication system is supported. In order to suppress certain alarm / emergency messages, this filter mechanism selects the error messages that shall not be reported to the PLC.

In object 0x285C, the corresponding error numbers are given in n subindex. Up to n = 10 error numbers can be selected.



If the "0xFFFFFFFF" error code is found in one of the subindices, all messages are blocked.

Parameter

Address	Name / setting range / [default setting]	Information
0x285C:001	Alarm supression: Entry 1 0x00000000 ... [0x00000000] ... 0xFFFFFFFF	Definition of error numbers that shall not be sent as alarm, emergency, or diagnostic message to the connected master. "0xFFFFFFFF"= suppression of all messages to the master.
0x285C:002	Alarm supression: Entry 2 0x00000000 ... [0x00000000] ... 0xFFFFFFFF	
0x285C:003	Alarm supression: Entry 3 0x00000000 ... [0x00000000] ... 0xFFFFFFFF	
0x285C:004	Alarm supression: Entry 4 0x00000000 ... [0x00000000] ... 0xFFFFFFFF	
0x285C:005	Alarm supression: Entry 5 0x00000000 ... [0x00000000] ... 0xFFFFFFFF	
0x285C:006	Alarm supression: Entry 6 0x00000000 ... [0x00000000] ... 0xFFFFFFFF	
0x285C:007	Alarm supression: Entry 7 0x00000000 ... [0x00000000] ... 0xFFFFFFFF	
0x285C:008	Alarm supression: Entry 8 0x00000000 ... [0x00000000] ... 0xFFFFFFFF	
0x285C:009	Alarm supression: Entry 9 0x00000000 ... [0x00000000] ... 0xFFFFFFFF	
0x285C:010	Alarm supression: Entry 10 0x00000000 ... [0x00000000] ... 0xFFFFFFFF	



12.7 CiA 402 device profile

The CiA® 402 device profile defines the functional behaviour of stepping motors, servo drives, and frequency inverters. In order to be able to describe the different drive types, various operating modes and device parameters are specified in the device profile. Each operating mode provides objects (e.g. for the setpoint speed, acceleration and deceleration) to generate the desired drive behaviour.

- CiA® is a registered community trademark of the CAN in Automation e. V user organisation.
- More information can be found in the CiA 402 specification (CANopen device profile for drives and Motion Control) of the CAN in Automation (CiA) user organisation: <http://www.can-cia.org>

12.7.1 Supported operating modes

The inverter only supports the CiA 402 operating mode "CiA: Velocity mode".

Details

In the following, the steps required for configuring the operating mode "CiA: Velocity mode" are described.

1. Set the operating mode "CiA: Velocity mode [2]" in 0x6060 (P301.00).
2. Set speed is specified via the parameter "Set speed" 0x6042 (P781.00).
3. Process input data and process output data are available for the control in the CiA402.

The following signal flow shows the internal setpoint logics:

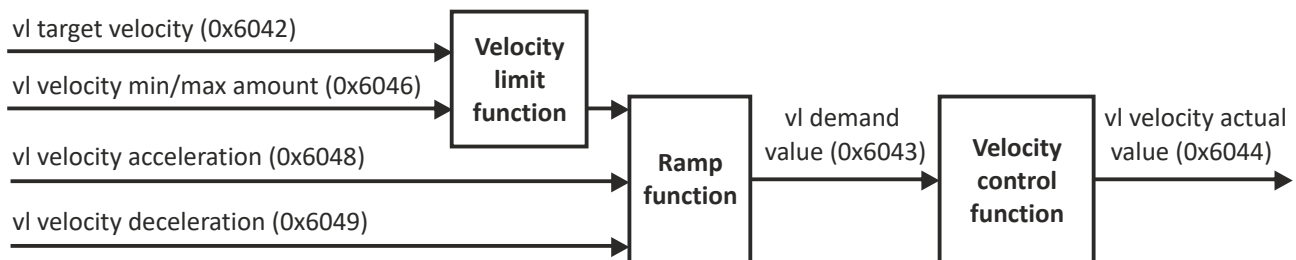

The "CiA: Velocity mode" operating mode is now active and the inverter reacts to the setpoint speed specified via the network.

Parameter

Address	Name / setting range / [default setting]	Information
0x6060 (P301.00)	CiA: Operation mode (Operation mode) • Setting can only be changed if the inverter is disabled.	CiA: Operation mode
	-2 MS: Velocity mode	Vendor specific velocity mode ▶ Configuring the frequency control 78
	-1 MS: Torque mode (from version 03.00)	Vendor specific torque mode • Only possible in motor control type 0x2C00 (P300.00) = "Sensorless vector control (SLVC) [4]". ▶ Configuring the torque control 146
	0 No selection	No selection
	2 CiA: Velocity mode	CiA: Velocity mode ▶ CiA 402 device profile 285
0x6061 (P788.00)	CiA: Active operation mode (Act. op. mode) • Read only	CiA: Active operation mode
	-2 MS: Velocity mode	Vendor specific velocity mode
	-1 MS: Torque mode (from version 03.00)	Manufacturer-specific torque mode
	0 No selection	No selection
	2 CiA: Velocity mode	CiA: Velocity mode

Configuring the network

CiA 402 device profile

Basic setting



Address	Name / setting range / [default setting]	Information
0x6502 (P789.00)	Supported drive modes (Supported modes) • Read only	Bit coded display of the operating modes supported.
	Bit 0 Reserved	-
	Bit 1 CiA: Velocity mode	1 = CiA: velocity mode is supported.
	Bit 2 Reserved	-
	Bit 3 Reserved	-
	Bit 5 Reserved	-
	Bit 6 Reserved	-
	Bit 7 Cyclic sync position mode	Always 0 (not supported).
	Bit 8 Cyclic sync velocity mode	
	Bit 9 Cyclic sync torque mode	
Bit 17 MS: Velocity mode	1 = vendor specific velocity mode is supported.	
Bit 18 MS: Torque mode	- 1 = Manufacturer-specific torque mode.	

12.7.2 Basic setting

Set the following parameters.

Parameter

Address	Name / setting range / [default setting]	Information
0x605A	CiA: Quick stop mode	Device status after exiting the quick stop ramp. • Setting is only effective in the operating mode 0x6060 (P301.00) = "CiA: Velocity mode [2]".
	2 Ramp > switch on disabled	Automatic change to the "Switch-on inhibited" device state. • The "Quick stop active [54]" status is reset to FALSE after ramp-down to standstill.
	6 Ramp > quick stop active	The inverter remains in the "Quick stop active" device state. • The "Quick stop active [54]" status remains TRUE until the "Quick stop" function is activated.
0x605B	Shutdown option code • From version 05.02	Defines the transition from the status "Operation enabled" to "Ready to start".
	0 Disable drive function	0: Immediate inverter disable (standard setting)
	1 Slow down on quick stop ramp and disable drive function	1: "Quick stop" with subsequent inverter disable.
0x6085 (P790.00)	Quick stop deceleration (Quick stop dec.) 0 ... [546000] ... 2147483647 pos. unit/s ²	Change in velocity used for deceleration to a standstill if quick stop is activated. • Setting is only effective in the operating mode 0x6060 (P301.00) = "CiA: Velocity mode [2]". • Setting is only effective in the operating mode 0x6060 (P301.00) = "CiA: Velocity mode [2]". • In operating mode 0x6060 (P301.00) = "MS: Velocity mode [-2]", the deceleration time set in 0x291C (P225.00) is effective. 0x6085 = (initial speed of the motor [rpm] / duration of the ramp until standstill [s]) * 1092



12.7.3 Process input data

The following diagram demonstrates the relationship of the parameters [0x6048:001 \(P785.01\)](#) and [0x6048:002 \(P785.02\)](#).

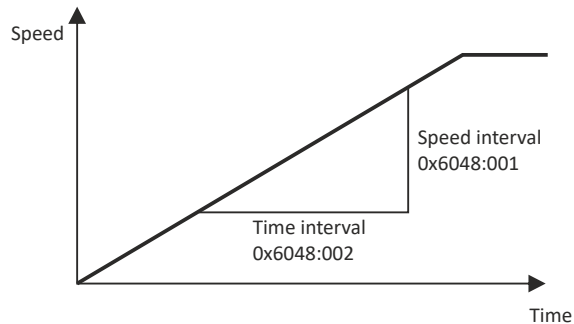

Parameter

Address	Name / setting range / [default setting]	Information
0x6042 (P781.00)	Set speed (Set speed) -32768 ... [0] ... 32767 rpm	Set speed (velocity mode).
0x6046:001 (P784.01)	Speed limits: Min. speed (Speed limits: Min. speed) 0 ... [0] ... 480000 rpm	Min. speed (velocity mode).
0x6046:002 (P784.02)	Speed limits: Max. speed (Speed limits: Max. speed) 0 ... [2147483647] ... 2147483647 rpm	Max. speed (velocity mode).
0x6048:001 (P785.01)	Acceleration ramp: CiA acceleration: Delta speed (Accel. ramp: Delta speed) 0 ... [3000] ... 2147483647 rpm	CiA acceleration: Delta speed
0x6048:002 (P785.02)	Acceleration ramp: CiA acceleration: Delta time (Accel. ramp: Delta time) 0 ... [10] ... 65535 s	CiA acceleration: Delta time
0x6049:001 (P786.01)	Deceleration ramp: CiA deceleration: Delta speed (Decel. ramp: Delta speed) 0 ... [3000] ... 2147483647 rpm	CiA deceleration: Delta speed
0x6049:002 (P786.02)	Deceleration ramp: CiA deceleration: Delta time (Decel. ramp: Delta time) 0 ... [10] ... 65535 s	CiA deceleration: Delta time
0x6071	Set torque -3276.8 ... [0.0] ... 3276.7 %	Setting of the setpoint torque for the torque operating modes. <ul style="list-style-type: none"> 100 % = Rated motor torque 0x6076 (P325.00) The inverter does not support the CiA 402 torque mode.

12.7.4 Process output data

Parameter

Address	Name / setting range / [default setting]	Information
0x6043 (P782.00)	Internal set speed (Int. set speed) <ul style="list-style-type: none"> Read only: x rpm 	Display of the internal set speed (velocity demand).
0x6044 (P783.00)	Actual speed (Actual speed) <ul style="list-style-type: none"> Read only: x rpm 	Display of the actual speed (velocity mode).
0x6074	Internal set torque <ul style="list-style-type: none"> Read only: x.x % From version 02.00 	Display of the internal set torque. <ul style="list-style-type: none"> 100 % = Rated motor torque 0x6076 (P325.00).

Configuring the network

CiA 402 device profile

Commands for device state control



12.7.5 Commands for device state control

0x6040 (CiA control word) can be used to trigger commands to put the inverter into a certain device state.

Command	Bit pattern in the CiA control word (0x6040)							
	Bit 7	Bit 6	Bit 5	Bit 4	Bit 3	Bit 2	Bit 1	Bit 0
	Reset fault	Dependent on the operating mode			Operation enable	Activating quick stop	Establish readiness for operation	Switch-on
Switch-off □ 289	0	X	X	X	X	1	1	0
Switch on □ 290	0	X	X	X	0	1	1	1
Enable operation □ 291	0	X	X	X	1	1	1	1
Activate quick stop □ 292	0	X	X	X	X	0	1	X
Disable operation □ 293	0	X	X	X	0	1	1	1
Pulse inhibit □ 294	0	X	X	X	X	X	0	X
Reset fault □ 295	0/1	X	X	X	X	X	X	X

X = state is not relevant

More Lenze-specific control bits (bit 8 ... 15)

Command	Bit pattern in the CiA control word (0x6040)							
	Bit 15	Bit 14	Bit 13	Bit 12	Bit 11	Bit 10	Bit 9	Bit 8
	Reserved	Release brake	Reserved	Dependent on the operating mode				Stop motor
Apply brake	X	0	X	X	X	X	X	X
Release brake	X	1	X	X	X	X	X	X
Stop motor	X	X	X	X	X	X	X	1

X = state is not relevant

Detailed information on the various commands can be found in the following sections.

Parameter

Address	Name / setting range / [default setting]	Information	
0x6040	CiA control word 0 ... [0] ... 65535	Mappable CiA control word with bit assignment according to device profile CiA 402.	
	Bit 0	Switch on	1 = switch-on
	Bit 1	Enable voltage	1 = Enable voltage
	Bit 2	Disable quick stop	0 = activate quick stop
	Bit 3	Enable operation	1 = Enable operation
	Bit 4	Operation mode specific	Operation mode specific
	Bit 5	Operation mode specific	
	Bit 6	Operation mode specific	
	Bit 7	Fault reset	0-1 edge = fault reset
	Bit 8	Halt (from version 04.00)	1 = stop motor (ramping down to frequency setpoint 0 Hz)
	Bit 9	Operation mode specific	Operating mode specific
	Bit 14	Release holding brake	1 = release holding brake ⚠ CAUTION! <ul style="list-style-type: none"> The manually triggered "Release holding brake" command has a direct impact on the "Release holding brake [115]" trigger. Thus, the holding brake can be manually released if the power section is switched off. The responsibility for a manual opening of the holding brake lies with the external trigger source for the "Release holding brake" command. ▶ Holding brake control □ 197

Example

A PLC program of a PLCopen control can, for instance, trigger several commands for state changes in a row by the level change at the *bRegulatorOn* input of the "MC_Power" block.

In the mentioned example, these device commands are "Switch-off" and "Switch on" in this order.



12.7.5.1 Switch-off

This command serves to change the "Switch-on inhibited" device state to the "Ready to switch on" device state.

If the pulse inhibit has already been deactivated and the device status of the inverter is "Operation enabled", this command sets the pulse inhibit again.

- If automatic brake operation is activated, the parameterized Brake closing time (0x2820:002 (P712.02)) is observed: The system waits until the brake is applied before the pulse inhibit is set. In the CiA 402 "CiA: Velocity mode", the Brake closing time is not observed.
- The motor has no torque.
- The device state "Switched on" or "Operation enabled" changes back to the "Ready to switch on" state.

⚠ DANGER!

Uncontrolled movement

If the motor has no torque, a load that is connected to motors without a holding brake may cause uncontrolled movements!

- ▶ Without a load, the motor will coast.

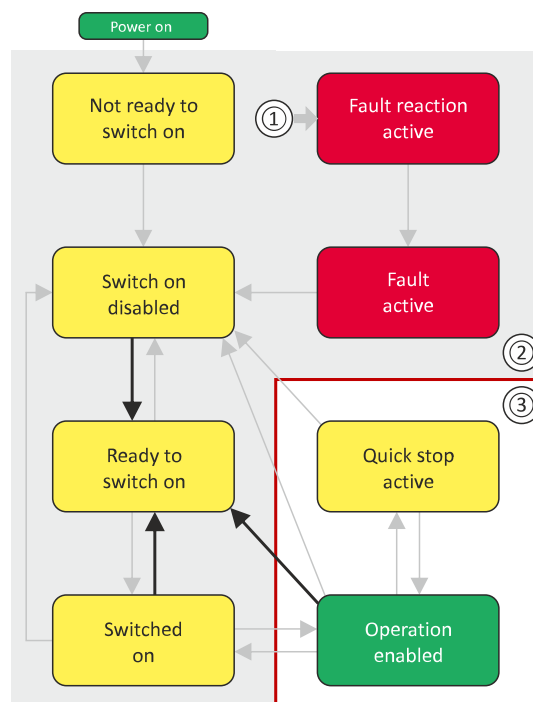

- 1 From all states
- 2 Power section disabled (pulse inhibit)
- 3 Power section enabled

Bit pattern in the CiA control word (0x6040)								
Bit 15 ... 8	Bit 7	Bit 6	Bit 5	Bit 4	Bit 3	Bit 2	Bit 1	Bit 0
Reserved (specific)	Reset fault	Operating mode dependent			Operation enabled	Activate quick stop	Establish readiness for operation	Switch-on
X	0	X	X	X	X	1	1	0

X = state is not relevant

Configuring the network

CiA 402 device profile
 Commands for device state control



12.7.5.2 Switch on

This command serves to deactivate the switch on inhibit which is active after switch on or after the reset (acknowledgement) of an error.

A changeover to the "Switched on" device status takes place.

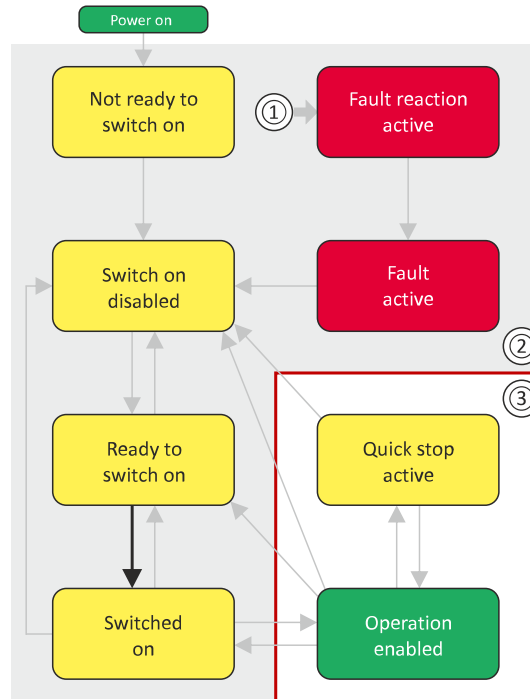

- 1 From all states
- 2 Power section inhibited (pulse inhibit)
- 3 Power section enabled

Bit pattern in the CiA control word (0x6040)								
Bit 15 ... 8	Bit 7	Bit 6	Bit 5	Bit 4	Bit 3	Bit 2	Bit 1	Bit 0
Reserved (specific)	Reset fault	Operating mode-dependent			Operation enabled	Activate quick stop	Establish readiness for operation	Switch-on
X	0	X	X	X	0	1	1	1

X = state is not relevant



12.7.5.3 Enable operation

This command enables the operation and stop an active quick stop again.

- A changeover to the "Operation enabled" device status takes place.
- The output stages of the inverter become active.

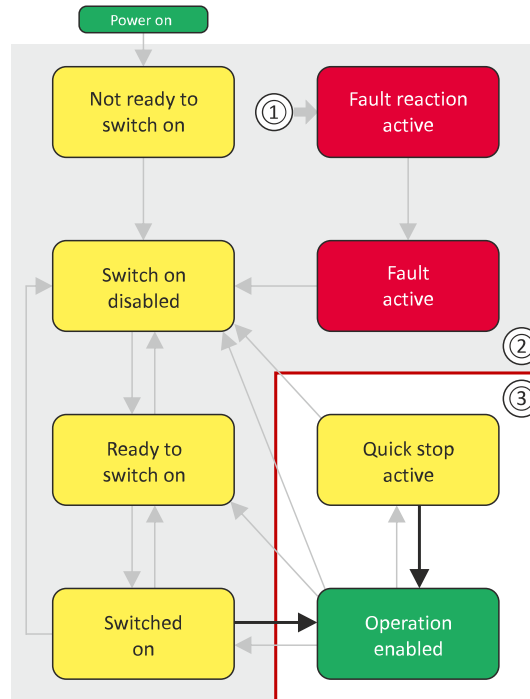

- 1 From all states
- 2 Power section inhibited (pulse inhibit)
- 3 Power section enabled

Bit pattern in the CiA control word (0x6040)								
Bit 15 ... 8	Bit 7	Bit 6	Bit 5	Bit 4	Bit 3	Bit 2	Bit 1	Bit 0
Reserved (specific)	Reset fault	Operating mode dependent			Operation enabled	Activate quick stop	Establish readiness for operation	Switch-on
X	0	X	X	X	1	1	1	1

X = state is not relevant

If the device status "Operation enabled" is signalled in the CiA status word, the inverter is ready to accept set points from the network master.

Configuring the network

CiA 402 device profile
 Commands for device state control



12.7.5.4 Activate quick stop

This command activates quick stop when the operation is enabled.

- The drive is brought to a standstill irrespective of the setpoint specified with the deceleration (0x6085 (P790.00)) set for quick stop.
- A changeover to the "Quick stop active" device status takes place.
- Then, state change to "Switch-on inhibited" parameter 0x605A "CiA: Quick stop mode".

If the operation is not enabled (device state "Ready to switch on" or "Switched on"), this command changes the state to "operation disabled".

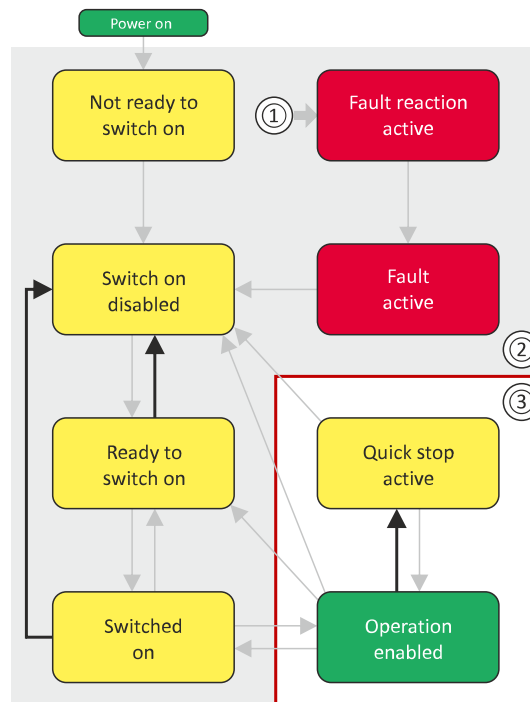

- 1 From all states
- 2 Power section disabled (pulse inhibit)
- 3 Power section enabled

Bit pattern in the CiA control word (0x6040)								
Bit 15 ... 8	Bit 7	Bit 6	Bit 5	Bit 4	Bit 3	Bit 2	Bit 1	Bit 0
Reserved (specific)	Reset fault	Operating mode dependent			Operation enabled	Activate quick stop	Establish readiness for operation	Switch-on
X	0	X	X	X	X	0	1	X

X = state is not relevant

- During quick stop, the inverter executes the setpoint generation and no longer follows the setpoint defined by the network master.
- If several inverters execute a chained synchronous motion, the quick stop function has to be coordinated by the network master by means of a quick stop profile (master function). In this case, quick stop cannot be activated via the control bit 2.
- During the quick stop, the maximum current (0x6073 (P324.00)) and the maximum torque (0x6072 (P326.00)) are active. The lower of the two limits determines the motor torque output. The torque limits from 0x60E0 and 0x60E1 are not effective during the quick stop.



12.7.5.5 Disable operation

This command disables the enabled operation again.

- The pulse inhibit is set (pulses of the inverter are inhibited).
- If automatic brake operation is activated, the parameterized Brake closing time (0x2820:002 (P712.02)) is observed: The system waits until the brake is applied before the pulse inhibit is set. In the CiA 402 "CiA: Velocity mode", the Brake closing time is not observed.
- A changeover to the "Switched on" device state takes place.

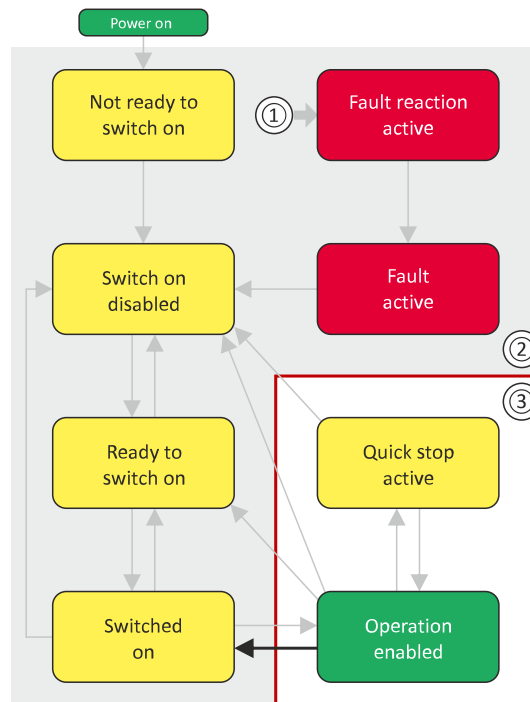

- 1 From all states
- 2 Power section disabled (pulse inhibit)
- 3 Power section enabled

Bit pattern in the CiA control word (0x6040)

Bit 15 ... 8	Bit 7	Bit 6	Bit 5	Bit 4	Bit 3	Bit 2	Bit 1	Bit 0
Reserved (specific)	Reset fault	Operating mode dependent			Operation enabled	Activate quick stop	Establish readiness for operation	Switch-on
X	0	X	X	X	0	1	1	1

X = state is not relevant

Configuring the network

CiA 402 device profile
 Commands for device state control



12.7.5.6 Pulse inhibit

This command disables the output stages of the inverter.

- The pulse inhibit is activated (pulses of the inverter are inhibited) if not already active.
- The motor has no torque.
- A changeover to the "Switch-on inhibited" device state takes place.

⚠ DANGER!

Uncontrolled movement

If the motor has no torque, a load that is connected to motors without a holding brake may cause uncontrolled movements!

- ▶ Without a load, the motor will coast.

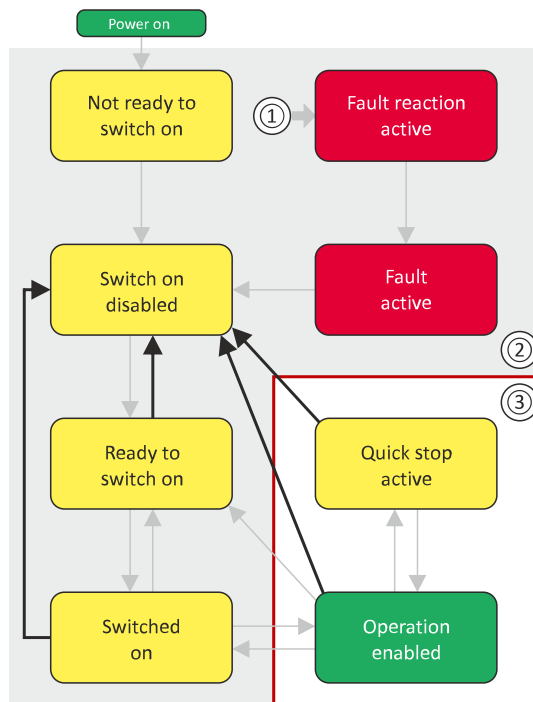

- 1 From all states
- 2 Power section inhibited (pulse inhibit)
- 3 Power section enabled

Bit pattern in the CiA control word (0x6040)

Bit 15 ... 8	Bit 7	Bit 6	Bit 5	Bit 4	Bit 3	Bit 2	Bit 1	Bit 0
Reserved (specific)	Reset fault	Operating mode dependent			Operation enabled	Activate quick stop	Establish readiness for operation	Switch-on
X	0	X	X	X	X	X	0	X

X = state is not relevant

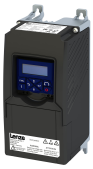

12.7.5.7 Reset fault

This command resets a pending fault if the cause of the fault has been eliminated.

- The pulse inhibit remains active (pulses of the inverter are inhibited).
- A changeover to the "Switch-on inhibited" device status takes place (switch-on inhibit remains active).

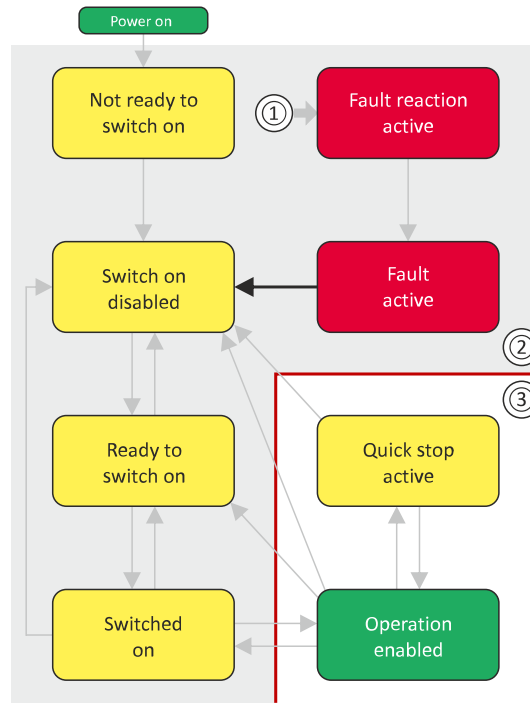

- 1 From all states
- 2 Power section inhibited (pulse inhibit)
- 3 Power section enabled

Bit pattern in the CiA control word (0x6040)								
Bit 15 ... 8	Bit 7	Bit 6	Bit 5	Bit 4	Bit 3	Bit 2	Bit 1	Bit 0
Reserved (specific)	Reset fault	Operating mode dependent			Operation enabled	Activating quick stop	Establish readiness for operation	Switch-on
X	0/1	X	X	X	X	X	X	X

X = state is not relevant

Configuring the network

CiA 402 device profile
Device states



12.7.6 Device states

[0x6041 \(P780.00\)](#) (CiA status word) displays the current device status of the inverter.

Status bit 7: "Warning active"

Status bit 7 indicates a warning.

- A warning does **not** cause a state change.
- Warnings do not need to be reset.

More Lenze-specific status bits (bit 8 ... 15)

Device state	Bit pattern in the CiA status word (0x6041 (P780.00))							
	Bit 15	Bit 14	Bit 13	Bit 12	Bit 11	Bit 10	Bit 9	Bit 8
	Not active	Brake released	Reserved	Reserved	Internal limitation is active	Target position reached	Control word processed successfully	RPDOs deactivated
Brake applied	X	0	0	0	X	X	X	X
Brake released	X	1	0	0	X	X	X	X
X = state is not relevant								

Detailed information on the various device states can be found in the following sections.

Parameter

Address	Name / setting range / [default setting]	Information	
0x6041 (P780.00)	CiA status word (CiA status word) • Read only	Mappable CiA status word with bit assignment according to device profile CiA 402.	
	Bit 0	Ready to switch on	1 = drive ready to start
	Bit 1	Switched on	1 = drive switched-on
	Bit 2	Operation enabled	1 = operation enabled
	Bit 3	Fault	1 = fault or trouble active
	Bit 4	Voltage enabled	1 = DC bus ready for operation
	Bit 5	Quick stop disabled	0 = quick stop active
	Bit 6	Switch on disabled	1 = operation inhibited
	Bit 7	Warning	1 = warning active
	Bit 8	RPDOs deactivated	1 = cyclic PDOs have been deactivated.
	Bit 9	CiA control enabled	1 = inverter can receive commands via network. • Bit is not set in the operating mode 0x6060 (P301.00) = "MS: Velocity mode [-2]".
	Bit 10	Setpoint reached	1 = the actual speed is in the window.
	Bit 11	Internal limit active	1 = internal limitation of a setpoint active.
	Bit 14	Holding brake released	1 = holding brake released
Bit 15	STO not active	0 = the inverter has been disabled by the integrated safety system 1 = the integrated safety system is not active Not available for i410 and i510 (always TRUE).	



12.7.6.1 Not ready to switch on

This is the device state of the inverter directly after switching on the supply voltage.

- In this device status, the device is initialised.
- Communication is not possible yet.
- The inverter cannot be parameterised yet and no device commands can be carried out yet.
- The motor brake, if available, is closed.
- Operation is inhibited.

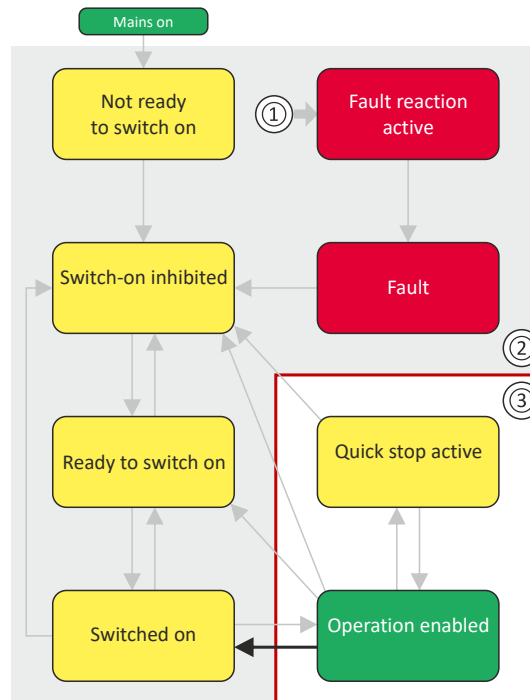

- 1 From all states
- 2 Power section inhibited (pulse inhibit)
- 3 Power section enabled

Bit pattern in the CiA status word (0x6041 (P780.00))								
Bit 15 ... 8	Bit 7	Bit 6	Bit 5	Bit 4	Bit 3	Bit 2	Bit 1	Bit 0
Reserved (specific)	Warning active	Operation inhibited	Quick stop active	DC bus ready for operation	Fault active	Operation enabled	Switched on	Ready to switch on
X	X	0	X	X	0	0	0	0

X = state is not relevant

Configuring the network

CiA 402 device profile
Device states



12.7.6.2 Switch-on inhibited

This is the device state of the inverter after the device has been initialized successfully.

- Process data monitoring is active.
- Communication is possible.
- The DC-bus voltage can be present.
- The inverter can be parameterized.
- If the internal holding brake control (0x2820:001 (P712.01)) is active in the inverter, the motor brake is closed.
- Operation is inhibited.

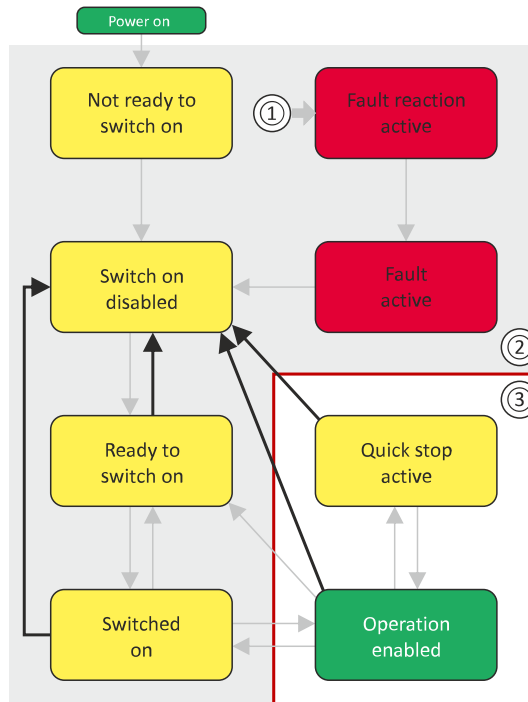

- 1 From all states
- 2 Power section inhibited (pulse inhibit)
- 3 Power section enabled

Bit pattern in the CiA 402 status word (0x6041 (P780.00))								
Bit 15 ... 8	Bit 7	Bit 6	Bit 5	Bit 4	Bit 3	Bit 2	Bit 1	Bit 0
Reserved (specific)	Warning is active	Operation inhibited	Quick stop active	DC bus ready for operation	Fault active	Operation enabled	Switched on	Ready to switch on
X	X	1	X	X	0	0	0	0

X = state is not relevant



12.7.6.3 Ready to switch on

This is the device state of the inverter after the device has been initialised successfully and after the **Switch-off** command has been triggered.

A change to this device state also takes place if the "Switch-off" command was triggered in the states "Switched on" or "Ready to switch on".

- Process data monitoring is active.
- Communication is possible.
- The DC-bus voltage is available.
- The inverter can be parameterised.
- If the internal holding brake control (0x2820:001 (P712.01)) is active in the inverter, the motor brake is closed.
- Operation is inhibited.

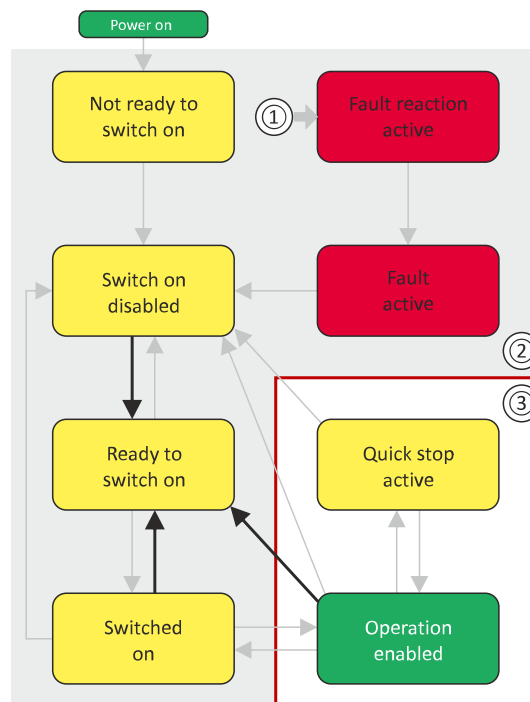

- 1 From all states
- 2 Power section inhibited (pulse inhibit)
- 3 Power section enabled

Bit pattern in the CiA status word (0x6041 (P780.00))

Bit 15 ... 8	Bit 7	Bit 6	Bit 5	Bit 4	Bit 3	Bit 2	Bit 1	Bit 0
Reserved (specific)	Warning active	Operation inhibited	Quick stop active	DC bus ready for operation	Fault active	Operation enabled	Switched on	Ready to switch on
X	X	0	1	X	0	0	0	1

X = state is not relevant

Configuring the network

CiA 402 device profile
Device states



12.7.6.4 Switched on

This is the device state of the inverter after the "Switch on" command has been triggered in the "Ready to switch on" device state.

- Process data monitoring is active.
- Communication is possible.
- The DC-bus voltage is available.
- The inverter can be parameterised.
- If the internal holding brake control (0x2820:001 (P712.01)) is active in the inverter, the motor brake is closed.
- Operation is inhibited.

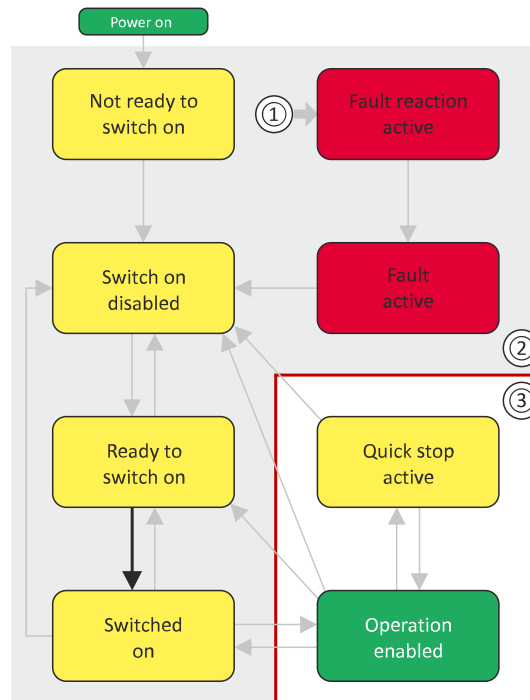

- 1 From all states
- 2 Power section inhibited (pulse inhibit)
- 3 Power section enabled

Bit pattern in the CiA status word (0x6041 (P780.00))								
Bit 15 ... 8	Bit 7	Bit 6	Bit 5	Bit 4	Bit 3	Bit 2	Bit 1	Bit 0
Reserved (specific)	Warning active	Operation inhibited	Quick stop active	DC bus ready for operation	Fault active	Operation enabled	Switched on	Ready to switch on
X	X	1	1	X	0	0	1	1

X = state is not relevant



12.7.6.5 Operation enabled

This device state represents normal operation. Operation in the selected operating mode is enabled and no errors have occurred.

- Only the parameters of the inverter can be changed that do not require an inverter disable.
- A motor brake, if any, is open if the automatic operation of the holding brake control is activated ($0x2820:001$ (P712.01) = 0).
- The drive control is active.

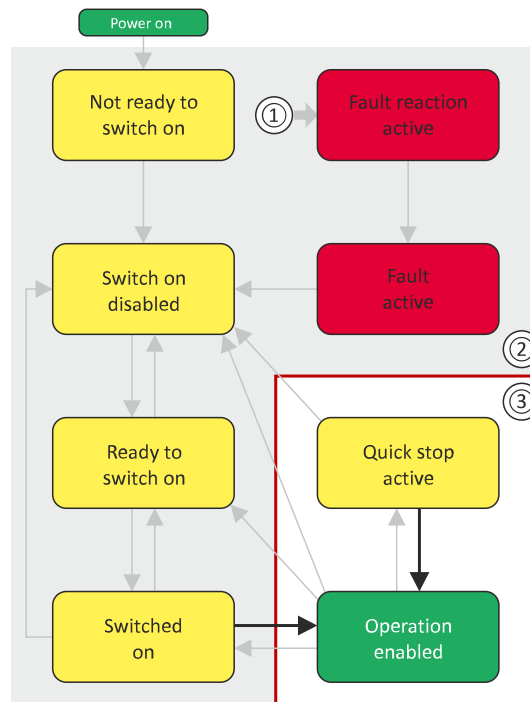

- 1 From all states
- 2 Power section inhibited (pulse inhibit)
- 3 Power section enabled

Bit pattern in the CiA status word (0x6041 (P780.00))								
Bit 15 ... 8	Bit 7	Bit 6	Bit 5	Bit 4	Bit 3	Bit 2	Bit 1	Bit 0
Reserved (specific)	Warning active	Operation inhibited	Quick stop active	DC bus ready for operation	Fault active	Operation enabled	Switched on	Ready to switch on
X	X	0	1	X	0	1	1	1

X = state is not relevant

If the device status "Operation enabled" is signalled in the CiA status word, the inverter is ready to accept set points from the network master.

Configuring the network

CiA 402 device profile
Device states



12.7.6.6 Quick stop active

This device state is active if quick stop is executed or active.

- Only the parameters of the inverter can be changed that do not require an inverter disable.
- If the internal holding brake control (0x2820:001 (P712.01)) is active in the inverter, the motor brake is closed.
- The drive control is active.

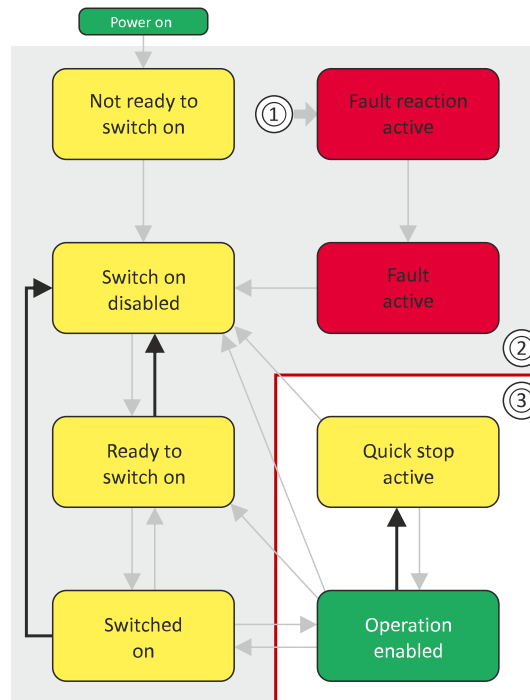

- 1 From all states
- 2 Power section inhibited (pulse inhibit)
- 3 Power section enabled

Bit pattern in the CiA status word (0x6041 (P780.00))

Bit 15 ... 8	Bit 7	Bit 6	Bit 5	Bit 4	Bit 3	Bit 2	Bit 1	Bit 0
Reserved (specific)	Warning active	Operation inhibited	Quick stop active	DC bus ready for operation	Fault active	Operation enabled	Switched on	Ready to switch on
X	X	0	0	X	0	1	1	1

X = state is not relevant

The "Enable operation" command stops an active quick stop.



12.7.6.7 Fault reaction active

This device state becomes active if a minor fault occurs. This means that the inverter is still able to drive the motor in a controlled way.

- The inverter is brought to a standstill irrespective of the setpoint specified with the deceleration (0x6085 (P790.00)) set for quick stop.

If the inverter is at standstill, a change to the "Trouble" device state take place automatically.

- Only the parameters of the inverter can be changed that do not require an inverter disable.
- If the internal holding brake control (0x2820:001 (P712.01)) is active in the inverter, the motor brake is closed.
- The drive control is active.

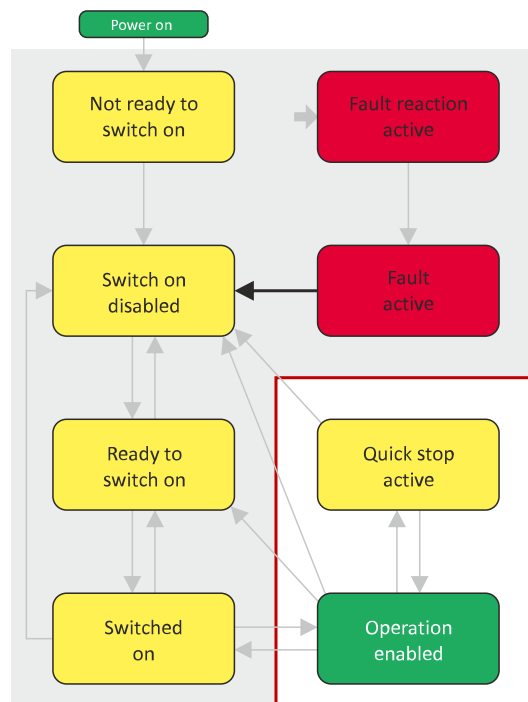

- From all states
- Power section inhibited (pulse inhibit)
- Power section enabled

Bit pattern in the CiA status word (0x6041 (P780.00))

Bit 15 ... 8	Bit 7	Bit 6	Bit 5	Bit 4	Bit 3	Bit 2	Bit 1	Bit 0
Reserved (specific)	Warning active	Operation inhibited	Quick stop active	DC bus ready for operation	Fault active	Operation enabled	Switched on	Ready to switch on
X	X	0	X	X	1	1	1	1

X = state is not relevant

Configuring the network

CiA 402 device profile
Device states



12.7.6.8 Trouble

This device state becomes active if a serious system fault occurs. This means that the inverter is no longer able to drive the motor in a controlled way. The inverter is switched off immediately.

- The pulse inhibit is active (pulses of the inverter are inhibited).
- The motor is torqueless.
- The motor brake, if available, is closed.
- Operation is inhibited.
- The inverter can be parameterised.

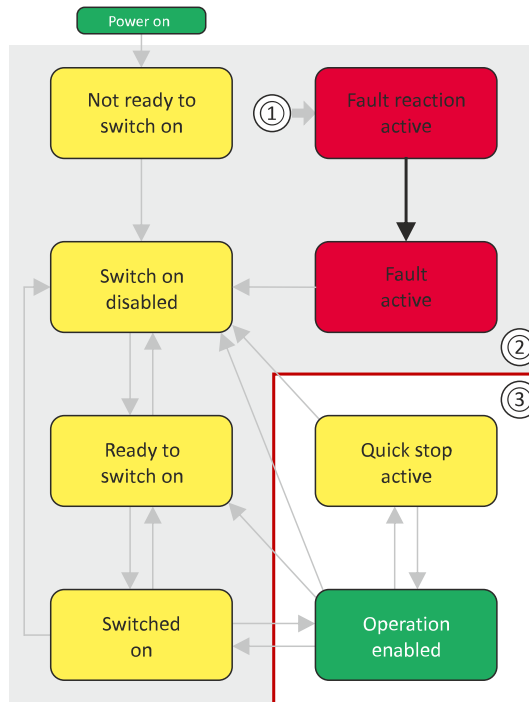

- 1 From all states
- 2 Power section inhibited (pulse inhibit)
- 3 Power section enabled

Bit pattern in the CiA status word (0x6041 (P780.00))								
Bit 15 ... 8	Bit 7	Bit 6	Bit 5	Bit 4	Bit 3	Bit 2	Bit 1	Bit 0
Reserved (specific)	Warning active	Operation inhibited	Quick stop active	DC bus ready for operation	Fault active	Operation enabled	Switched on	Ready to switch on
X	X	0	X	X	1	0	0	0

X = state is not relevant

This device state can only be left with the "Reset fault" command if the cause of the fault has been removed.



12.8 AC drive

For control via the AC drive profile, the parameters listed in the following can be mapped to network registers.

- Mapping entry for the AC Drive control word (0x400B:001 (P592.01)): 0x400B0110
- Mapping entry for the AC Drive status word (0x400C:001 (P593.01)): 0x400C0110
- Detailed information on the data mapping can be found in the chapter of the corresponding network.

12.8.1 AC drive control word

The AC drive control word (0x400B:001 (P592.01)) will only be processed if the network control in 0x2631:037 (P400.37) has been activated and the network is also active as the control source.

► [Changing the control source during operation](#) 72

Moreover, some bits in the control word are ignored if the bit 5 "Activate network control" is not set. For details see the parameter description for 0x400B:001 (P592.01).

The following logic applies to bit 0 "Run forward (CW)" and bit 1 "Run reverse (CCW)":

Bit 0 "Run forward (CW)"	Bit 1 "Run reverse (CCW)"	Action
0	0	Stopping with stop method set in 0x2838:003 (P203.03).
0∇1 (edge)	0	Run forward (CW)
0	0∇1 (edge)	Run reverse (CCW)
0∇1 (edge)	0∇1 (edge)	No action / last action is continued to be executed.
1	1	
1	0	
0	1	
1∨0 (edge)	1	Run reverse (CCW)
1	1∨0 (edge)	Run forward (CW)

Parameter

Address	Name / setting range / [default setting]	Information
0x400B:001 (P592.01)	Process input data: AC Drive control word (Process data IN: AC control word) 0x0000 ... [0x0000] ... 0xFFFF	Mappable control word with bit assignment in compliance with EtherNet/IP™ AC drive profile.
	Bit 0 Run forward (CW)	Bits are only evaluated if bit 5 = "1".
	Bit 1 Run reverse (CCW)	For the exact logic, see the above truth table.
	Bit 2 Reset error (0-1 edge)	
	Bit 5 Activate network control	If bit 5 = "1" and 0x2631:037 (P400.37) = "Network control active [114]": All bits of the AC Drive control word are evaluated. If bit 5 = "0" or 0x2631:037 (P400.37) = "Not connected [0]": • Bit 0, 1, 6, 12, 13, 14, 15 of the AC drive control word are not evaluated (ignored). • Active control source is the "Flexible I/O configuration". ► Changing the control source during operation 72
	Bit 6 Activate network setpoint	0 = the standard setpoint source selected in 0x2860:001 (P201.01) is used. Bits are only evaluated if bit 5 = "1". 1 = network setpoint is used. For control without bit 5, the "Network setpoint active [116]" selection must be set in .
	Bit 12 Disable inverter	Bits are only evaluated if bit 5 = "1".
	Bit 13 Activate quick stop	
Bit 14 Deactivate PID controlling		
Bit 15 Activate DC braking		

Configuring the network

AC drive
AC drive status word



12.8.2 AC drive status word

Parameter

Address	Name / setting range / [default setting]	Information	
0x400C:001 (P593.01)	Process output data: AC Drive status word (Process data OUT: AC status word) • Read only	Mappable status word with bit assignment in compliance with EtherNet/IP™ AC drive profile.	
	Bit 0	Fault/Trip active	
	Bit 1	Warning active	
	Bit 2	Running forward	
	Bit 3	Running reverse	
	Bit 4	Ready	
	Bit 5	Network control active	
	Bit 6	Network setpoint active	
	Bit 7	At Reference	
	Bit 8	Profile-State bit 0	The drive status is coded as follows: 0: Manufacturer-specific (reserved) 1: Startup (drive initialisation) 2: Not_Ready (mains voltage switched off) 3: Ready (mains voltage switched on) 4: Enabled (drive has received run command) 5: Stopping (drive has received stop command and is stopped) 6: Fault_Stop (drive is stopped due to a fault) 7: Faulted (faults have occurred)
	Bit 9	Profile-State bit 1	
	Bit 10	Profile-State bit 2	
	Bit 11	Profile-State bit 3	
	Bit 12	Process controller active	
	Bit 13	Torque mode active	
	Bit 14	Current limit reached	
Bit 15	DC braking active		

12.8.3 AC motor type

Parameter

Address	Name / setting range / [default setting]	Information	
0x6402	Motor type • From version 02.00	AC motor type • Motor Data Object (0x28) - instance attribute 3	
	3		PM synchronous
	7		Squirrel cage induction



12.9 Lenze LECOM profile

For connection to Lenze inverters with a LECOM control word (C135) and LECOM status word (C150), the parameters listed in the following can be mapped to network registers.

Details

Mapping entries

- LECOM control word (0x400B:002 (P592.02)): 0x400B0210
- LECOM status word (0x400C:002 (P593.02)): 0x400C0210
- Detailed information on the data mapping can be found in the chapter of the corresponding network.

Parameter

Address	Name / setting range / [default setting]	Information
0x400B:002 (P592.02)	Process input data: LECOM control word (Process data IN: LECOM ctrl word) 0x0000 ... [0x0000] ... 0xFFFF	Mappable control word with bit assignment in compliance with code C135 of the 8200 Lenze inverter.
	Bit 0 Activate preset (bit 0)	
	Bit 1 Activate preset (bit 1)	
	Bit 2 Reverse rotational direction	
	Bit 3 Activate quick stop	
	Bit 9 Disable inverter	
	Bit 10 Activate user fault	
	Bit 11 Reset error (0-1 edge)	
0x400C:002 (P593.02)	Process output data: LECOM status word (Process data OUT: LECOM stat. word) • Read only	Mappable status word with bit assignment in compliance with code C150 of the 8200 Lenze inverter.
	Bit 0 Active parameter set (0 = set 1 or 3; 1 = set 2 or 4)	
	Bit 1 Power section inhibited	
	Bit 2 Current or Torque limit reached	
	Bit 3 Frequency setpoint reached	
	Bit 4 Ramp generator (input = output)	
	Bit 5 Frequency < frequency threshold	
	Bit 6 Actual frequency = 0	
	Bit 7 Inverter disabled	
	Bit 8 Coded status bit 0	
	Bit 9 Coded status bit 1	
	Bit 10 Coded status bit 2	
	Bit 11 Coded status bit 3	
	Bit 12 Overtemperature warning	
	Bit 13 DC-bus overvoltage	
Bit 14 Rotational direction reversed		
Bit 15 Ready for Operation		



12.10 CANopen



CANopen® is an internationally approved communication protocol which is designed for commercial and industrial automation applications. High data transfer rates in connection with efficient data formatting provide for the coordination of motion control devices in multi-axis applications.

- CANopen® is a registered community trademark of the CAN in Automation e. V user organisation.
- Detailed information on CANopen can be found on the web page of the CAN in Automation (CiA) user organisation: <http://www.can-cia.org>
- Information about the dimensioning of a CANopen network can be found in the configuration document for the inverter.

Details

- The implementation of the CANopen communication profile (CiA DS301, version 4.02) enables baud rates of 20 kbps to 1 Mbps.
- For establishing a simple network connection, the inverter provides predefined control and status words for these profiles.
 - ▶ [CiA 402 device profile](#) [📖 285](#)
 - ▶ [AC drive](#) [📖 305](#)
 - ▶ [Lenze LECOM profile](#) [📖 307](#)

There are also additional mappable data words to individually control the inverter:





- The inverter control is preconfigured via a CiA control word.



12.10.1 Commissioning

In the following, the steps required for controlling the inverter via CANopen are described.

Parameterization required

1. Set the CANopen node address.
 - Each network node must be provided with a unique node address.
 - Details: [▶ Node address setting](#)  313
2. Set the CANopen baud rate.
 - Default setting: 500 = kbit/s
 - Details: [▶ Baud rate setting](#)  313
3. Optional: Configure inverter as "mini master".
 - Required if the initialization of the CANopen network and the associated status change from "Pre-Operational" to "Operational" is not effected by a higher-level host system.
 - Details: [▶ Configuring the device as mini master](#)  313
4. Optional: Change the response of the inverter to the triggering of the RPDO time monitoring.
 - Default setting: In case of missing RPDOs, an error is triggered.
 - Details: [▶ Error responses](#)  326
5. Save parameter settings: `0x2022:003 (P700.03) = "On / start = [1]"`.
6. Switch the inverter off and then on again in order that the changed communication settings can get effective.
7. Program the master so that the following SDO messages are sent to the inverter:
 1. `0x2631:037 (P400.37) = 1` (activate network control)
 2. `0x2860:001 (P201.01) = 5` (set network as standard setpoint source)
 3. PDO mapping and configuration of the process data objects RPDO1 and TPDO1 (see the sections "[RPDO1 mapping modification](#)" and "[TPDO1 mapping modification](#)").
8. Control inverter via RPDO1 (and evaluate the current status via TPDO1).
 - For assignment of the control word and setpoint selection, see section "[RPDO1 mapping modification](#)".
 - For assignment of the status word and actual value output, see section "[TPDO1 mapping modification](#)".
 - Acceleration `0x2917 (P220.00)` and deceleration `0x2918 (P221.00)` can be set/changed via SDO messages.



In the default setting, the digital input DI1 is assigned the "Run" function. If the network control is activated, this function serves as "start enable" for start commands via network. Hence, the digital input DI1 must be set to the HIGH level in order that the motor can be started via the network.

[▶ Flexible I/O configuration of the start, stop and rotating direction commands](#)  54

Configuring the network

CANopen
Commissioning



RPDO1 mapping modification

The RPDO1 is used to control the inverter.

Changing the identifier (COB-ID) and the PDO mapping only allows the following procedure:

1. Set RPDO1 to "invalid": Set bit 31 in the identifier [0x1400:001 \(P540.01\)](#) = 1.
2. Set RPDO1 mapping to "invalid": set [0x1600:000](#) = 0
3. Map NetWordIN1 data word [0x4008:001 \(P590.01\)](#) to RPDO1: set [0x1600:001](#) = 0x40080110.
4. Network setpoint frequency (0.1) [0x400B:003 \(P592.03\)](#) to RPDO1: set [0x1600:002](#) = 0x400B0310.
5. Set RPDO1 mapping to "valid" again: set [0x1600:000](#) = 2 (number of mapped parameters).
6. Optional: Set timeout time for monitoring the data reception in [0x1400:005 \(P540.05\)](#) in [ms].
 - Default setting: 100 ms
7. Change identifier for RPDO1 (optional) and set RPDO1 to "valid" again: Write the new identifier into [0x1400:001 \(P540.01\)](#) and simultaneously set bit 31 to "0".
 - Default setting: 0x200 + node address (hex)
 - Example: Node address = 10 (0xA) and basic identifier = default setting:
Identifier to be written into = 0x200 + 0xA = 0x20A = (0b0011 0000 1010)

Function assignment of the NetWordIN1 data word (byte 1+2 of the RPDO1)

Bit	Default setting	For details and configuration, see
0	Not active (reserve)	0x400E:001 (P505.01)
1	Not active (reserve)	0x400E:002 (P505.02)
2	Activate quick stop	0x400E:003 (P505.03)
3	Not active (reserve)	0x400E:004 (P505.04)
4	Run forward (CW)	0x400E:005 (P505.05)
5	Activate preset (bit 0)	0x400E:006 (P505.06)
6	Activate preset (bit 1)	0x400E:007 (P505.07)
7	Reset error	0x400E:008 (P505.08)
8	Not active (reserve)	0x400E:009 (P505.09)
9	Activate DC braking	0x400E:010 (P505.10)
10	Not active (reserve)	0x400E:011 (P505.11)
11	Not active (reserve)	0x400E:012 (P505.12)
12	Reverse rotational direction	0x400E:013 (P505.13)
13	Not active (reserve)	0x400E:014 (P505.14)
14	Not active (reserve)	0x400E:015 (P505.15)
15	Not active (reserve)	0x400E:016 (P505.16)

Specifying the frequency setpoint (byte 3+4 of the RPDO1)

- The specification is made unsigned (independent of the direction of rotation) as integer in the resolution [0.1 Hz].
- The direction of rotation is defined in the default setting via bit 12 of the NetWordIN1 data word.
- Example: 456 = 45.6 Hz



TPDO1 mapping modification

The TPDO1 is used for the output of status information and the actual frequency value.

Changing the identifier (COB-ID) and the PDO mapping only allows the following procedure:

1. Set TPDO1 to "invalid": Set bit 31 in the identifier [0x1800:001 \(P550.01\)](#) = 1.
2. Set TPDO1 mapping to "invalid": set [0x1A00:000](#) = 0.
3. Map NetWordOUT1 data word [0x400A:001 \(P591.01\)](#) to TPDO1:
set [0x1A00:001](#) = 0x400A0110.
4. Frequency (0.1) [0x400B:003 \(P592.03\)](#) to TPDO1: set [0x1A00:002](#) = 0x400C0310.
5. Set TPDO1 mapping to "valid" again: set [0x1A00:000](#) = 2 (number of mapped parameters).
6. Option: Transmission type in [0x1800:002 \(P550.02\)](#) Event timer in [0x1800:005 \(P550.05\)](#).
 - Default setting: Cyclic transmission every 20 ms.
7. Change identifier for TPDO1 (optional) and set TPDO1 to "valid" again: Write the new identifier into [0x1800:001 \(P550.01\)](#) and simultaneously set bit 31 to "0".
 - Default setting: 0x40000180 + node address (hex)
 - Example: Node address = 10 (0xA) and TPDO1 basic identifier = default setting:
Identifier to be written into [0x1800:001 \(P550.01\)](#) = 0x40000180 + 0xA = 0x4000018A
(0b0100 0000 0000 0000 0000 0001 1000 1010)

Status assignment of the NetWordOUT1 data word (byte 1+2 of the TPDO1)

Bit	Default setting	For details and configuration, see
0	Ready for operation	0x2634:010 (P420.10)
1	Not connected	0x2634:011 (P420.11)
2	Operation enabled	0x2634:012 (P420.12)
3	Fault active	0x2634:013 (P420.13)
4	Not connected	0x2634:014 (P420.14)
5	Quick stop active	0x2634:015 (P420.15)
6	Running	0x2634:016 (P420.16)
7	Device warning active	0x2634:017 (P420.17)
8	Not connected	0x2634:018 (P420.18)
9	Not connected	0x2634:019 (P420.19)
10	Setpoint speed reached	0x2634:020 (P420.20)
11	Current limit reached	0x2634:021 (P420.21)
12	Actual speed = 0	0x2634:022 (P420.22)
13	Rotational direction reversed	0x2634:023 (P420.23)
14	Release holding brake	0x2634:024 (P420.24)
15	Inverter disabled (safety)	0x2634:025 (P420.25)

Output of the actual frequency value (byte 3+4 of the TPDO1)

- The output is made unsigned (independent of the direction of rotation) as integer in the resolution [0.1 Hz].
- An active reversal is displayed via bit 13 of the NetWordOUT1 data word.
- Example: 456 = 45.6 Hz

Restart of the communication

A restart of communication is required after changes of the interface configuration (e. g. node address and baud rate) in order that the changed settings become effective.

For restarting communication, there are two options:

- a) Switch inverter off and on again.
- b) [0x2300 \(P508.00\)](#) Set = "Restart with current values [1]".

The following parameter can be used to restart or stop communication.

Optionally it is also possible to reset all communication parameters to the default status.

Configuring the network

CANopen
Commissioning



Parameter

Address	Name / setting range / [default setting]	Information
0x2300 (P508.00)	CANopen communication (CANopen comm.) <ul style="list-style-type: none">Setting can only be changed if the inverter is disabled.	Restart / stop communication. <ul style="list-style-type: none">After successful execution, the value 0 is shown.
	0 No action/no error	Only status feedback
	1 Restart with current values	Restart communication with the current values.
	2 Restart with default values	Restart communication with the standard values of the CAN parameters (0x1000 ... 0x1FFF and 0x2301).
	5 Stop network communication	Stop communication. <ul style="list-style-type: none">The "Stop Remote Node" NMT command is executed. After successful execution of this command, only the reception of network management frames is possible.
	10 In progress	Only status feedback
	11 Action cancelled	
12 Fault		



12.10.2 Basic setting and options

12.10.2.1 Node address setting

Each network node must be provided with a unique node address.

Parameter

Address	Name / setting range / [default setting]	Information
0x2301:001 (P510.01)	CANopen settings: Node ID (CANopen sett.: Node ID) 1 ... [1] ... 127	Setting of the node address. • A change in the node address will not be effective until a CAN Reset Node is performed.

12.10.2.2 Baud rate setting

All network nodes must be set to the same baud rate.

Details

- The baud rate can be set in [0x2301:002 \(P510.02\)](#).
- The setting that is active when the inverter is switched on is the effective setting.
- The active baud rate is displayed in [0x2302:002 \(P511.02\)](#).

Parameter

Address	Name / setting range / [default setting]	Information
0x2301:002 (P510.02)	CANopen settings: Baud rate (CANopen sett.: Baud rate)	Setting of the baud rate. • A change in the baud rate will not be effective until a CAN reset node is performed.
	0 Automatic (from version 03.00)	
	1 20 kbps	Setting of the baud rate. • A change in the baud rate will not be effective until a CAN reset node is performed.
	2 50 kbps	
	3 125 kbps	
	4 250 kbps	
	5 500 kbps	
	6 800 kbps	
7 1 Mbps		

12.10.2.3 Configuring the device as mini master

If the initialisation of the CANopen network and the associated status change from "Pre-Operational" to "Operational" is not effected by a master (PLC), the inverter can instead be defined as a "mini master" to execute this task.

Details

The inverter is configured as mini master in [0x2301:003 \(P510.03\)](#).

- In the default setting, the inverter is configured as slave and waits for the NMT telegram "Start Remote Node" from the master (PLC) in the "Pre-Operational" state after being switched on.
- Configured as mini master, the inverter changes to the "Operational" state after being switched on and sets all nodes connected to the CAN bus (broadcast telegram) to the "Operational" communication state using the "Start Remote Node" NMT telegram after the deceleration time set in [0x2301:004 \(P510.04\)](#) has elapsed. Only this communication status enables data exchange via the process data objects.



The change of the master/slave operation only becomes effective by renewed mains switching of the inverter or by sending the NMT telegram "Reset Node" or "Reset Communication" to the inverter. Alternatively, the CAN communication can be restarted via [0x2300 \(P508.00\)](#).

Parameter

Address	Name / setting range / [default setting]	Information
0x2301:003 (P510.03)	CANopen settings: Slave/Master (CANopen sett.: Slave/Master)	1 = after mains switching, inverter starts as mini-master.
	0 Slave	
	1 Mini-master	

Configuring the network

CANopen

Basic setting and options



Address	Name / setting range / [default setting]	Information
0x2301:004 (P510.04)	CANopen settings: Start remote delay (CANopen sett.: Start rem. delay) 0 ... [3000] ... 65535 ms	If the inverter has been defined as mini-master, a delay time can be set here, which has to elapse after mains switching before the inverter deposits the "Start Remote Node" NMT telegram on the CAN bus.



12.10.3 Process data transfer

Process data objects (PDOs) are used for the cyclic transmission of (process) data via CANopen. PDOs only contain data and an identifier. They do not contain any information about the sender or receiver and are therefore very efficient.

Details

- Process data objects which the inverter receives via the network are referred to as "Receive PDOs" (RPDOs).
- Process data objects which the inverter sends via the network are referred to as "Transmit PDOs" (TPDOs).
- The maximum length of a PDO is 8 bytes (4 data words).
- Each PDO requires a unique identifier ("COB-ID") for the purpose of identification within the network.
- Communication parameters such as the transmission type and cycle time for each PDO can be set freely and independently of the settings of other PDOs

Transmission type

Process data objects can be transmitted in an event-controlled or time-controlled manner. The below table shows that it is possible to combine the different methods by means of logic operations (AND, OR):

- Event-controlled: The PDO is sent if a special device-internal event has occurred, for instance, if the data contents of the TPDO have changed or if a transmission cycle time has elapsed.
- Synchronous transmission: Transmission of a TPDOs or reception of an RPDO is effected after the inverter has received a sync telegram (COB-ID 0x80).
- Cyclic transmission: The cyclic transmission of PDOs is effected when the transmission cycle time has elapsed.
- Polled via RTR: Transmission of a TPDO is carried out on request by another device via data request frame (RTR remote transmit request). For this, the data requester (e.g. master) sends the data request frame with the COB-ID of the TPDO that is to be requested to transmit. The receiver recognises the RTR and carries out the transmission.

Transmission type	PDO transmission			Logic combination of different transmission types
	cyclic	synchronous	event-controlled	
0		●	●	AND
1 ... 240		●		-
254, 255	●		●	OR

Transmission type	Description
0	Synchronous and acyclic <ul style="list-style-type: none"> • The PDO is transmitted on an event-controlled basis with every sync (e.g. when a bit change occurs in the PDO).
1 ... 240	Synchronous and cyclic (sync-controlled with a response) <ul style="list-style-type: none"> • Selection n = 1: The PDO is transmitted with every sync. • Selection 1 < n ≤ 240: The PDO is transmitted with every n-th sync.
241 ... 251	Reserved
252	Synchronous - RTR only
253	Asynchronous - RTR only
254, 255	Asynchronous - manufacturer-specific / device profile-specific <ul style="list-style-type: none"> • If the value 255 is entered, sending and receiving takes place in the set cycle time. Linked signals are also sent and received every time the PDO is changed. The PDO is event-driven and cyclically transmitted. • If the value 254 is entered, sending and receiving takes place in the set cycle time. A change in the PDO linked signals has no influence.

Configuring the network

CANopen
Process data transfer



Synchronisation of PDOs via sync telegram

During cyclic transmission, one or more PDOs are transmitted/received in fixed time intervals. An additional specific telegram, the so-called sync telegram, is used for synchronising cyclic process data.

- The sync telegram is the trigger point for the transmission of process data from the slaves to the master and for the acceptance of process data from the master in the slaves.
- For sync-controlled process data processing, the sync telegram must be generated accordingly.
- The response to a sync telegram is determined by the transmission type selected.

Generating the sync telegram:

- **0x1005** can be used to activate the generation of sync telegrams and to write the identifier value.
- Sync telegrams are created when bit 30 (see below) is set to "1".
- The interval between sync telegrams is to be set in **0x1006**.

Writing identifiers:

- To receive sync telegrams, the value 0x80 must be entered in the 11-bit identifier in the default setting (and in compliance with the CANopen specification). This means that all inverters are set to the same sync telegram by default.
- If sync telegrams are only to be received by specific nodes, their identifiers can be entered with a value of up to and including 0x07FF.
- The identifier can only be changed if the inverter does not send any sync telegrams (**0x1005**, Bit 30 = "0").

Data telegram assignment

8th byte (data 4)		7th byte (data 3)	6th byte (data 2)	5th byte (data 1)
Bit 31	Bit 30	Bit 29 ... bit 11		Bit 10 ... bit 0
x	0/1	Extended identifier*		11-bit identifier

* The extended identifier is not supported. Bit 11 ... bit 29 must be set to "0".

Parameter

Address	Name / setting range / [default setting]	Information
0x1005	COB-ID SYNC 0x00000000 ... [0x00000080] ... 0xFFFFFFFF	Identifier for sync telegram. How to change the identifier: 1. Deactivate Sync: Set bit 30 to "0". 2. Change identifier. 3. Activate Sync: Set bit 30 to "1".
0x1006	Communication cyclic period 0 ... [0] ... 65535000 us	Cycle time for sync telegrams. • With the setting "0", no sync telegrams are generated. • The set time is internally rounded up to the next multiple of 10 ms. The shortest possible cycle time thus is 10 ms.
0x1400:000	RPDO1 communication parameter: Highest sub-index supported • Read only	
0x1400:001 (P540.01)	RPDO1 communication parameter: COB-ID (RPDO1 config.: COB-ID) 0x00000000 ... [0x00000200] ... 0xFFFFFFFF	RPDO1: identifier How to change the identifier: 1. Set PDO to "invalid": Set bit 31 to "1". 2. Change identifier and reset PDO to "valid" (bit 31 = "0").
	Bit 0	COB-ID bit 0
	Bit 1	COB-ID bit 1
	Bit 2	COB-ID bit 2
	Bit 3	COB-ID bit 3
	Bit 4	COB-ID bit 4
	Bit 5	COB-ID bit 5
	Bit 6	COB-ID bit 6
	Bit 7	COB-ID bit 7
	Bit 8	COB-ID bit 8
	Bit 9	COB-ID bit 9
	Bit 10	COB-ID bit 10
	Bit 31	PDO invalid



Configuring the network

CANopen
Process data transfer

Address	Name / setting range / [default setting]	Information
0x1400:002 (P540.02)	RPDO1 communication parameter: Transmission type (RPDO1 config.: Transm. type) 0 ... [255] ... 255	RPDO1: transmission type in compliance with DS301 V4.02
0x1400:005 (P540.05)	RPDO1 communication parameter: Event timer (RPDO1 config.: Event timer) 0 ... [100] ... 65535 ms	RPDO1: time-out for the monitoring of data reception.
0x1401:001 (P541.01)	RPDO2 communication parameter: COB-ID (RPDO2 config.: COB-ID) 0x00000000 ... [0x80000300] ... 0xFFFFFFFF	RPDO2: identifier How to change the identifier: 1. Set PDO to "invalid": Set bit 31 to "1". 2. Change identifier and reset PDO to "valid" (bit 31 = "0").
	Bit 0 COB-ID bit 0	
	Bit 1 COB-ID bit 1	
	Bit 2 COB-ID bit 2	
	Bit 3 COB-ID bit 3	
	Bit 4 COB-ID bit 4	
	Bit 5 COB-ID bit 5	
	Bit 6 COB-ID bit 6	
	Bit 7 COB-ID bit 7	
	Bit 8 COB-ID bit 8	
	Bit 9 COB-ID bit 9	
	Bit 10 COB-ID bit 10	
	Bit 31 PDO invalid	
0x1401:002 (P541.02)	RPDO2 communication parameter: Transmission type (RPDO2 config.: Transm. type) 0 ... [255] ... 255	RPDO2: transmission type in compliance with DS301 V4.02
0x1401:005 (P541.05)	RPDO2 communication parameter: Event timer (RPDO2 config.: Event timer) 0 ... [100] ... 65535 ms	RPDO2: time-out for the monitoring of data reception.
0x1402:001 (P542.01)	RPDO3 communication parameter: COB-ID (RPDO3 config.: COB-ID) 0x00000000 ... [0x80000400] ... 0xFFFFFFFF	RPDO3: identifier How to change the identifier: 1. Set PDO to "invalid": Set bit 31 to "1". 2. Change identifier and reset PDO to "valid" (bit 31 = "0").
	Bit 0 COB-ID bit 0	
	Bit 1 COB-ID bit 1	
	Bit 2 COB-ID bit 2	
	Bit 3 COB-ID bit 3	
	Bit 4 COB-ID bit 4	
	Bit 5 COB-ID bit 5	
	Bit 6 COB-ID bit 6	
	Bit 7 COB-ID bit 7	
	Bit 8 COB-ID bit 8	
	Bit 9 COB-ID bit 9	
	Bit 10 COB-ID bit 10	
	Bit 31 PDO invalid	
0x1402:002 (P542.02)	RPDO3 communication parameter: Transmission type (RPDO3 config.: Transm. type) 0 ... [255] ... 255	RPDO3: transmission type in compliance with DS301 V4.02
0x1402:005 (P542.05)	RPDO3 communication parameter: Event timer (RPDO3 config.: Event timer) 0 ... [100] ... 65535 ms	RPDO3: time-out for the monitoring of data reception.
0x1800:000	TPDO1 communication parameter: Highest sub-index supported • Read only	The value "5" is permanently set.

Configuring the network

CANopen
Process data transfer



Address	Name / setting range / [default setting]	Information
0x1800:001 (P550.01)	TPDO1 communication parameter: COB-ID (TPDO1 config.: COB-ID) 0x00000001 ... [0x40000180] ... 0xFFFFFFFF	TPDO1: identifier How to change the identifier: 1. Set PDO to "invalid": Set bit 31 to "1". 2. Change identifier and reset PDO to "valid" (bit 31 = "0").
	Bit 0 COB-ID bit 0	
	Bit 1 COB-ID bit 1	
	Bit 2 COB-ID bit 2	
	Bit 3 COB-ID bit 3	
	Bit 4 COB-ID bit 4	
	Bit 5 COB-ID bit 5	
	Bit 6 COB-ID bit 6	
	Bit 7 COB-ID bit 7	
	Bit 8 COB-ID bit 8	
	Bit 9 COB-ID bit 9	
	Bit 10 COB-ID bit 10	
	Bit 30 RTR not allowed	
Bit 31 PDO invalid		
0x1800:002 (P550.02)	TPDO1 communication parameter: Transmission type (TPDO1 config.: Transm. type) 0 ... [255] ... 255	TPDO1: transmission type in compliance with DS301 V4.02
0x1800:003 (P550.03)	TPDO1 communication parameter: Inhibit time (TPDO1 config.: Inhibit time) 0.0 ... [0.0] ... 6553.5 ms	TPDO1: minimum time between the transmission of two identical PDOs (see DS301 V4.02). • The set time between is internally rounded up to the next multiple of 10ms.
0x1800:005 (P550.05)	TPDO1 communication parameter: Event timer (TPDO1 config.: Event timer) 0 ... [20] ... 65535 ms	TPDO1: Cycle time for PDO transmission with transmission type "254" or "255". • The set time is internally rounded up to the next multiple of 10 ms.
0x1801:000	TPDO2 communication parameter: Highest sub-index supported • Read only	The value "5" is permanently set.
0x1801:001 (P551.01)	TPDO2 communication parameter: COB-ID (TPDO2 config.: COB-ID) 0x00000001 ... [0xC0000280] ... 0xFFFFFFFF	TPDO2: identifier How to change the identifier: 1. Set PDO to "invalid": Set bit 31 to "1". 2. Change identifier and reset PDO to "valid" (bit 31 = "0").
	Bit 0 COB-ID bit 0	
	Bit 1 COB-ID bit 1	
	Bit 2 COB-ID bit 2	
	Bit 3 COB-ID bit 3	
	Bit 4 COB-ID bit 4	
	Bit 5 COB-ID bit 5	
	Bit 6 COB-ID bit 6	
	Bit 7 COB-ID bit 7	
	Bit 8 COB-ID bit 8	
	Bit 9 COB-ID bit 9	
	Bit 10 COB-ID bit 10	
	Bit 30 RTR not allowed	
Bit 31 PDO invalid		
0x1801:002 (P551.02)	TPDO2 communication parameter: Transmission type (TPDO2 config.: Transm. type) 0 ... [255] ... 255	TPDO2: transmission type in compliance with DS301 V4.02
0x1801:003 (P551.03)	TPDO2 communication parameter: Inhibit time (TPDO2 config.: Inhibit time) 0.0 ... [0.0] ... 6553.5 ms	TPDO2: minimum time between the transmission of two identical PDOs (see DS301 V4.02).
0x1801:005 (P551.05)	TPDO2 communication parameter: Event timer (TPDO2 config.: Event timer) 0 ... [0] ... 65535 ms	TPDO2: Cycle time for PDO transmission with transmission type "254" or "255". • The set time is internally rounded up to the next multiple of 10 ms.
0x1802:000	TPDO3 communication parameter: Highest sub-index supported • Read only	The value "5" is permanently set.



Configuring the network

CANopen
Process data transfer

Address	Name / setting range / [default setting]	Information
0x1802:001 (P552.01)	TPDO3 communication parameter: COB-ID (TPDO3 config.: COB-ID) 0x00000001 ... [0xC0000380] ... 0xFFFFFFFF	TPDO3: identifier How to change the identifier: 1. Set PDO to "invalid": Set bit 31 to "1". 2. Change identifier and reset PDO to "valid" (bit 31 = "0").
	Bit 0 COB-ID bit 0	
	Bit 1 COB-ID bit 1	
	Bit 2 COB-ID bit 2	
	Bit 3 COB-ID bit 3	
	Bit 4 COB-ID bit 4	
	Bit 5 COB-ID bit 5	
	Bit 6 COB-ID bit 6	
	Bit 7 COB-ID bit 7	
	Bit 8 COB-ID bit 8	
	Bit 9 COB-ID bit 9	
	Bit 10 COB-ID bit 10	
Bit 30 RTR not allowed		
Bit 31 PDO invalid		
0x1802:002 (P552.02)	TPDO3 communication parameter: Transmission type (TPDO3 config.: Transm. type) 0 ... [255] ... 255	TPDO3: transmission type in compliance with DS301 V4.02
0x1802:003 (P552.03)	TPDO3 communication parameter: Inhibit time (TPDO3 config.: Inhibit time) 0.0 ... [0.0] ... 6553.5 ms	TPDO3: minimum time between the transmission of two identical PDOs (see DS301 V4.02).
0x1802:005 (P552.05)	TPDO3 communication parameter: Event timer (TPDO3 config.: Event timer) 0 ... [0] ... 65535 ms	TPDO3: Cycle time for PDO transmission with transmission type "254" or "255". <ul style="list-style-type: none"> The set time is internally rounded up to the next multiple of 10 ms.
0x2301:006 (P510.06)	CANopen settings: COB-ID Configuration - PDO (CANopen sett.: COB-IDConfig PDO) <ul style="list-style-type: none"> From version 03.00 	Selection of the process for assigning the identifiers. Irrespective of this selection, these are the following bits of the identifiers: <ul style="list-style-type: none"> Bit 30: "RTR not allowed" (only in case of TPDO) Bit 31: "PDO invalid"
	0 Base + node-ID	Identifier = set (basic) identifiers + set node address
	1 Freely configurable	Identifier = set identifiers
	2 Legacy base + node ID	Identifier = inherited (basic) identifier + set node address

Configuring the network

CANopen
Process data transfer



12.10.3.1 Data mapping

Data mapping serves to define which process data are transmitted cyclically via the process data channels.

Details

Data mapping (in the case of CANopen also referred to as "PDO mapping") is preconfigured for control of the inverter via the device profile CiA 402:

- RPDO1 = **0x6040** (CiA control word) and **0x6042 (P781.00)** (Set speed).
- TPDO1 = **0x6041 (P780.00)** (CiA status word) and **0x6044 (P783.00)** (Actual speed).

Variable PDO mapping

The inverter supports variable PDO mapping for individual drive solutions. With 8 mapping entries each, 8-bit, 16-bit and 32-bit parameters can be assigned to a PDO in any order.



The total length of the mapped parameters must not exceed 8 bytes. The PDO mapping cannot be applied to all parameters. The mappable parameters are marked correspondingly in the parameter attribute list. [▶ Parameter attribute list](#) 480

The process of variable PDO mapping only allows the following procedure:

1. Set PDO to "invalid": set bit 31 in the corresponding identifier (**0x1400:001 (P540.01)**)
...
0x1402:001 (P542.01) or **0x1800:001 (P550.01)**
...
0x1802:001 (P552.01) to "1".
2. Set PDO mapping to "invalid": set subindex 0 in the mapping parameter (**0x1600:000**)
...
0x1602:000 or **0x1A00:000**
...
0x1A02:000 to "0".
3. Set desired PDO mapping via the corresponding mapping entries.
Format: Oxiiiissl
(iiii = hexadecimal index,
ss = hexadecimal subindex,
ll = hexadecimal data length)
4. Set subindex 0 in the mapping parameter (**0x1600:000**)
...
0x1602:000 or **0x1A00:000**
...
0x1A02:000 to valid value (number of mapped parameters).
5. Set PDO back to "valid": set bit 31 in the corresponding identifier (**0x1400:001 (P540.01)**)
...
0x1402:001 (P542.01) or **0x1800:001 (P550.01)**
...
0x1802:001 (P552.01) to "0".

Parameter

Address	Name / setting range / [default setting]	Information
0x1600:000	RPDO1 mapping parameter: Number of mapped application objects in PDO 0 ... [2] ... 8	Number of objects mapped in RPDO1.
0x1600:001	RPDO1 mapping parameter: Application object 1 0x00000000 ... [0x60400010] ... 0xFFFFFFFF	Mapping entry 1 for RPDO1.
0x1600:002	RPDO1 mapping parameter: Application object 2 0x00000000 ... [0x60420010] ... 0xFFFFFFFF	Mapping entry 2 for RPDO1.
0x1600:003	RPDO1 mapping parameter: Application object 3 0x00000000 ... [0x00000000] ... 0xFFFFFFFF	Mapping entry 3 for RPDO1.
0x1600:004	RPDO1 mapping parameter: Application object 4 0x00000000 ... [0x00000000] ... 0xFFFFFFFF	Mapping entry 4 for RPDO1.



Configuring the network

CANopen
Process data transfer

Address	Name / setting range / [default setting]	Information
0x1600:005	RPDO1 mapping parameter: Application object 5 0x00000000 ... [0x00000000] ... 0xFFFFFFFF	Mapping entry 5 for RPDO1.
0x1600:006	RPDO1 mapping parameter: Application object 6 0x00000000 ... [0x00000000] ... 0xFFFFFFFF	Mapping entry 6 for RPDO1.
0x1600:007	RPDO1 mapping parameter: Application object 7 0x00000000 ... [0x00000000] ... 0xFFFFFFFF	Mapping entry 7 for RPDO1.
0x1600:008	RPDO1 mapping parameter: Application object 8 0x00000000 ... [0x00000000] ... 0xFFFFFFFF	Mapping entry 8 for RPDO1.
0x1601:000	RPDO2 mapping parameter: Number of mapped application objects in PDO 0 ... [0] ... 8	Number of objects mapped in RPDO2.
0x1601:001	RPDO2 mapping parameter: Application object 1 0x00000000 ... [0x00000000] ... 0xFFFFFFFF	Mapping entry 1 for RPDO2.
0x1601:002	RPDO2 mapping parameter: Application object 2 0x00000000 ... [0x00000000] ... 0xFFFFFFFF	Mapping entry 2 for RPDO2.
0x1601:003	RPDO2 mapping parameter: Application object 3 0x00000000 ... [0x00000000] ... 0xFFFFFFFF	Mapping entry 3 for RPDO2.
0x1601:004	RPDO2 mapping parameter: Application object 4 0x00000000 ... [0x00000000] ... 0xFFFFFFFF	Mapping entry 4 for RPDO2.
0x1601:005	RPDO2 mapping parameter: Application object 5 0x00000000 ... [0x00000000] ... 0xFFFFFFFF	Mapping entry 5 for RPDO2.
0x1601:006	RPDO2 mapping parameter: Application object 6 0x00000000 ... [0x00000000] ... 0xFFFFFFFF	Mapping entry 6 for RPDO2.
0x1601:007	RPDO2 mapping parameter: Application object 7 0x00000000 ... [0x00000000] ... 0xFFFFFFFF	Mapping entry 7 for RPDO2.
0x1601:008	RPDO2 mapping parameter: Application object 8 0x00000000 ... [0x00000000] ... 0xFFFFFFFF	Mapping entry 8 for RPDO2.
0x1602:000	RPDO3 mapping parameter: Number of mapped application objects in PDO 0 ... [0] ... 8	Number of objects mapped in RPDO3.
0x1602:001	RPDO3 mapping parameter: Application object 1 0x00000000 ... [0x00000000] ... 0xFFFFFFFF	Mapping entry 1 for RPDO3.
0x1602:002	RPDO3 mapping parameter: Application object 2 0x00000000 ... [0x00000000] ... 0xFFFFFFFF	Mapping entry 2 for RPDO3.
0x1602:003	RPDO3 mapping parameter: Application object 3 0x00000000 ... [0x00000000] ... 0xFFFFFFFF	Mapping entry 3 for RPDO3.
0x1602:004	RPDO3 mapping parameter: Application object 4 0x00000000 ... [0x00000000] ... 0xFFFFFFFF	Mapping entry 4 for RPDO3.
0x1602:005	RPDO3 mapping parameter: Application object 5 0x00000000 ... [0x00000000] ... 0xFFFFFFFF	Mapping entry 5 for RPDO3.
0x1602:006	RPDO3 mapping parameter: Application object 6 0x00000000 ... [0x00000000] ... 0xFFFFFFFF	Mapping entry 6 for RPDO3.
0x1602:007	RPDO3 mapping parameter: Application object 7 0x00000000 ... [0x00000000] ... 0xFFFFFFFF	Mapping entry 7 for RPDO3.
0x1602:008	RPDO3 mapping parameter: Application object 8 0x00000000 ... [0x00000000] ... 0xFFFFFFFF	Mapping entry 8 for RPDO3.
0x1A00:000	TPDO1 mapping parameter: Number of mapped application objects in TPDO 0 ... [2] ... 8	Number of objects mapped in TPDO1.
0x1A00:001	TPDO1 mapping parameter: Application object 1 0x00000000 ... [0x60410010] ... 0xFFFFFFFF	Mapping entry 1 for TPDO1.
0x1A00:002	TPDO1 mapping parameter: Application object 2 0x00000000 ... [0x60440010] ... 0xFFFFFFFF	Mapping entry 2 for TPDO1.
0x1A00:003	TPDO1 mapping parameter: Application object 3 0x00000000 ... [0x00000000] ... 0xFFFFFFFF	Mapping entry 3 for TPDO1.
0x1A00:004	TPDO1 mapping parameter: Application object 4 0x00000000 ... [0x00000000] ... 0xFFFFFFFF	Mapping entry 4 for TPDO1.
0x1A00:005	TPDO1 mapping parameter: Application object 5 0x00000000 ... [0x00000000] ... 0xFFFFFFFF	Mapping entry 5 for TPDO1.
0x1A00:006	TPDO1 mapping parameter: Application object 6 0x00000000 ... [0x00000000] ... 0xFFFFFFFF	Mapping entry 6 for TPDO1.

Configuring the network

CANopen
Process data transfer



Address	Name / setting range / [default setting]	Information
0x1A00:007	TPDO1 mapping parameter: Application object 7 0x00000000 ... [0x00000000] ... 0xFFFFFFFF	Mapping entry 7 for TPDO1.
0x1A00:008	TPDO1 mapping parameter: Application object 8 0x00000000 ... [0x00000000] ... 0xFFFFFFFF	Mapping entry 8 for TPDO1.
0x1A01:000	TPDO2 mapping parameter: Number of mapped application objects in TPDO 0 ... [0] ... 8	Number of objects mapped in TPDO2.
0x1A01:001	TPDO2 mapping parameter: Application object 1 0x00000000 ... [0x00000000] ... 0xFFFFFFFF	Mapping entry 1 for TPDO2.
0x1A01:002	TPDO2 mapping parameter: Application object 2 0x00000000 ... [0x00000000] ... 0xFFFFFFFF	Mapping entry 2 for TPDO2.
0x1A01:003	TPDO2 mapping parameter: Application object 3 0x00000000 ... [0x00000000] ... 0xFFFFFFFF	Mapping entry 3 for TPDO2.
0x1A01:004	TPDO2 mapping parameter: Application object 4 0x00000000 ... [0x00000000] ... 0xFFFFFFFF	Mapping entry 4 for TPDO2.
0x1A01:005	TPDO2 mapping parameter: Application object 5 0x00000000 ... [0x00000000] ... 0xFFFFFFFF	Mapping entry 5 for TPDO2.
0x1A01:006	TPDO2 mapping parameter: Application object 6 0x00000000 ... [0x00000000] ... 0xFFFFFFFF	Mapping entry 6 for TPDO2.
0x1A01:007	TPDO2 mapping parameter: Application object 7 0x00000000 ... [0x00000000] ... 0xFFFFFFFF	Mapping entry 7 for TPDO2.
0x1A01:008	TPDO2 mapping parameter: Application object 8 0x00000000 ... [0x00000000] ... 0xFFFFFFFF	Mapping entry 8 for TPDO2.
0x1A02:000	TPDO3 mapping parameter: Number of mapped application objects in TPDO 0 ... [0] ... 8	Number of objects mapped in TPDO3.
0x1A02:001	TPDO3 mapping parameter: Application object 1 0x00000000 ... [0x00000000] ... 0xFFFFFFFF	Mapping entry 1 for TPDO3.
0x1A02:002	TPDO3 mapping parameter: Application object 2 0x00000000 ... [0x00000000] ... 0xFFFFFFFF	Mapping entry 2 for TPDO3.
0x1A02:003	TPDO3 mapping parameter: Application object 3 0x00000000 ... [0x00000000] ... 0xFFFFFFFF	Mapping entry 3 for TPDO3.
0x1A02:004	TPDO3 mapping parameter: Application object 4 0x00000000 ... [0x00000000] ... 0xFFFFFFFF	Mapping entry 4 for TPDO3.
0x1A02:005	TPDO3 mapping parameter: Application object 5 0x00000000 ... [0x00000000] ... 0xFFFFFFFF	Mapping entry 5 for TPDO3.
0x1A02:006	TPDO3 mapping parameter: Application object 6 0x00000000 ... [0x00000000] ... 0xFFFFFFFF	Mapping entry 6 for TPDO3.
0x1A02:007	TPDO3 mapping parameter: Application object 7 0x00000000 ... [0x00000000] ... 0xFFFFFFFF	Mapping entry 7 for TPDO3.
0x1A02:008	TPDO3 mapping parameter: Application object 8 0x00000000 ... [0x00000000] ... 0xFFFFFFFF	Mapping entry 8 for TPDO3.



12.10.4 Parameter data transfer

Service data objects (SDOs) make it possible to read and write all parameters of the inverter via CANopen.

Details

- Two independent SDO channels are provided at the same time. SDO channel 1 is always active. SDO channel 2 can be activated via [0x2301:005 \(P510.05\)](#).
- An SDO is always transmitted with confirmation, i. e. the reception of an SDO frame is acknowledged by the receiver.
- The identifiers for SDO1 and SDO2 are generated from the basic identifier (in compliance with the "Predefined Connection Set") and the node address set:

Object	Direction		Identifier
	to the device	from the device	
SDO1	●		Basic identifier 0x600 + node address
		●	Basic identifier 0x580 + node address
SDO2	●		Basic identifier 0x640 + node address
		●	Basic identifier 0x5C0 + node address

Structure of the SDO frame user data

The user data are shown in Motorola format:

1st byte	2nd byte	3rd byte	4th byte	5th byte	6th byte	7th byte	8th byte
Command	Index		Subindex	Data 1	Data 2	Data 3	Data 4
See table below.	LOW byte	HIGH byte		LOW word		HIGH word	
	Address of the parameter to be read or written.			LOW byte	HIGH byte	LOW byte	HIGH byte

The following commands can be transmitted or received for writing and reading the parameters:

Command	1st byte		Data length	Info
	hex	dec		
Write request	0x23	35	4 bytes	Writing of a parameter to the inverter.
	0x2B	43	2 bytes	
	0x2F	47	1 byte	
	0x21	33	Block	
Write response	0x60	96	4 bytes	Inverter acknowledges a write request.
Read request	0x40	64	4 bytes	Reading of a parameter from the inverter.
Read response	0x43	67	4 bytes	Inverter response to a read request with the current parameter value.
	0x4B	75	2 bytes	
	0x4F	79	1 byte	
	0x41	65	Block	
Error response	0x80	128	4 bytes	Inverter response to the incorrect execution of the read/write request.

More precisely, the command byte comprises the following information:

Command	1st byte							
	Command specifier (cs)			Toggle (t)	Length*		e	s
	Bit 7	Bit 6	Bit 5	Bit 4	Bit 3	Bit 2	Bit 1	Bit 0
Write request	0	0	1	0	0/1	0/1	1	1
Write response	0	1	1	0	0	0	0	0
Read request	0	1	0	0	0	0	0	0
Read response	0	1	0	0	0/1	0/1	1	1
Error response	1	0	0	0	0	0	0	0

*Bit coding of the length: 00 = 4 bytes, 01 = 3 bytes, 10 = 2 bytes, 11 = 1 byte
e: expedited (shortened block service)
s: segmented (normal block service)

More commands are defined in the DS301 V4.02 CANopen specification (e. g. segmented transfer).

Configuring the network

CANopen
Parameter data transfer



Up to 4 bytes are available for parameter value entries. Depending on the data format, they are assigned as follows:

5th byte	6th byte	7th byte	8th byte
Parameter value (1 byte)	0x00	0x00	0x00
Parameter value (2 bytes)		0x00	0x00
LOW byte	HIGH byte		
Parameter value (4 bytes)			
LOW word		HIGH word	
LOW byte	HIGH byte	LOW byte	HIGH byte



The parameter attribute list in the annex also specifies a so-called “scaling factor”. The scaling factor is relevant to the transmission of parameter values which are represented with one or several decimal positions in the parameter list. If the scaling factor is > 1, the value must be multiplied with the scaling factor specified before the transmission, so that the value can be transferred completely (as an integer value). On the SDO client side, the integer value must then be divided by the scaling factor again, in order to receive the original value with decimal positions.

Parameter

Address	Name / setting range / [default setting]	Information
0x1200:000	SDO1 server parameter: Highest sub-index supported • Read only	
0x1200:001	SDO1 server parameter: COB-ID client > server (rx) • Read only	Display of the receive identifier for SDO server channel 1 (basic SDO channel). • According to DS301 V4.02, the basic SDO channel can neither be changed nor deactivated.
0x1200:002	SDO1 server parameter: COB-ID server > client (tx) • Read only	Display of the transmit identifier for SDO server channel 1 (basic SDO channel). • According to DS301 V4.02, the basic SDO channel can neither be changed nor deactivated.
0x1201:000	SDO2 server parameter: Highest sub-index supported • Read only	
0x1201:001	SDO2 server parameter: COB-ID client > server (rx) 0x00000000 ... [0x80000640] ... 0xFFFFFFFF	Specification of the receive identifier for SDO server channel 2. • If SDO server channel 2 is activated via 0x2301:005 (P510.05), this parameter is set to the value "node address + 0x640". This default setting can be changed.
0x1201:002	SDO2 server parameter: COB-ID server > client (tx) 0x00000000 ... [0x800005C0] ... 0xFFFFFFFF	Specification of the transmit identifier for SDO server channel 2. • If SDO server channel 2 is activated via 0x2301:005 (P510.05), this parameter is set to the value "node address + 0x5C0". This default setting can be changed.
0x1201:003	SDO2 server parameter: Node-ID of the SDO client 1 ... [0] ... 127	Specification of the node address for the SDO client.
0x2301:005 (P510.05)	CANopen settings: Activate SDO2 channel (CANopen sett.: SDO2 channel)	1 = activate SDO server channel 2.
	0 Not active	
	1 Active	
0x2301:007 (P510.07)	CANopen settings: COB-ID Configuration - SDO2 (CANopen sett.: COB-IDConfigSDO2)	1 = COB-ID configuration -SDO 2 freely configurable.
	0 Base + node-ID	
	1 Freely configurable	



12.10.5 Monitoring

12.10.5.1 Emergency telegram

If the error status changes when an internal device error occurs or is remedied, an emergency telegram is sent to the NMT master once.

Details

- The identifier for the emergency telegram is fixedly defined and is shown in [0x1014](#).
- In [0x1015](#), a blocking time can be set, in order to limit the bus load in the case of emergency telegrams following quickly in succession.

Parameter

Address	Name / setting range / [default setting]	Information
0x1014	COB-ID Emergency telegram (EMCY) • Read only	Display of the identifier for emergency telegrams.
0x1015	Inhibit time EMCY 0.0 ... [0.0] ... 6553.5 ms	Blocking time which can be set in order to limit the bus load in the case of emergency telegrams following quickly in succession.

12.10.5.2 Heartbeat protocol

The heartbeat protocol can be used for node monitoring purposes within a CAN network.

Basic procedure

1. A heartbeat producer cyclically sends a heartbeat telegram to one or several receivers (consumers).
2. The consumer(s) monitor(s) the heartbeat telegram for arrival on a regular basis.

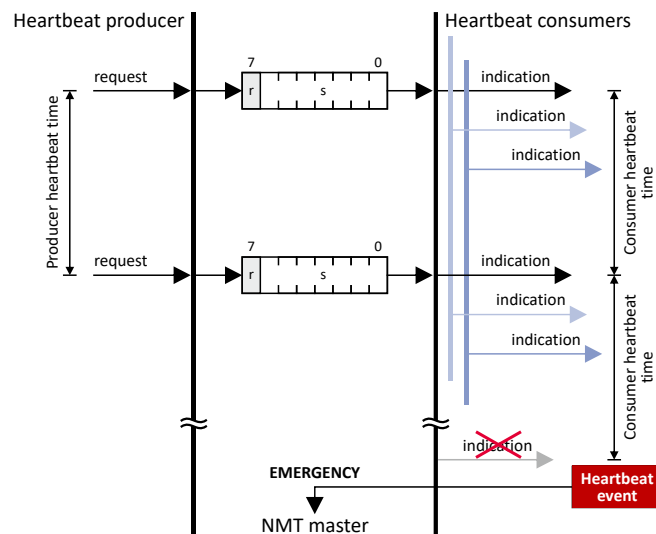

The inverter can be configured as producer or as consumer to monitor up to four other nodes.

Parameter

Address	Name / setting range / [default setting]	Information
0x1016:000 (P520.00)	Consumer heartbeat time: Highest sub-index supported (Cons. heartbeat: Highest subindex) • Read only	Highest subindex, permanently set to 4. Corresponds at the same time to the maximum possible number of nodes to be monitored.
0x1016:001 (P520.01)	Consumer heartbeat time: Consumer heartbeat time 1 (Cons. heartbeat: Cons. heartbeat1) 0x00000000 ... [0x00000000] ... 0x00FFFFFF	Node ID and heartbeat time of node 1 which is to be monitored. • Format: 0x00nnhhhh (nn = node ID, hhhh = heartbeat time in [ms])
0x1016:002 (P520.02)	Consumer heartbeat time: Consumer heartbeat time 2 (Cons. heartbeat: Cons. heartbeat2) 0x00000000 ... [0x00000000] ... 0x00FFFFFF	Node ID and heartbeat time of node 2 which is to be monitored. • Format: 0x00nnhhhh (nn = node ID, hhhh = heartbeat time in [ms])

Configuring the network

CANopen
Monitoring



Address	Name / setting range / [default setting]	Information
0x1016:003 (P520.03)	Consumer heartbeat time: Consumer heartbeat time 3 (Cons. heartbeat: Cons. heartbeat3) 0x00000000 ... [0x00000000] ... 0x00FFFFFF	Node ID and heartbeat time of node 3 which is to be monitored. • Format: 0x00nnhhhh (nn = node ID, hhhh = heartbeat time in [ms])
0x1016:004 (P520.04)	Consumer heartbeat time: Consumer heartbeat time 4 (Cons. heartbeat: Cons. heartbeat4) 0x00000000 ... [0x00000000] ... 0x00FFFFFF	Node ID and heartbeat time of node 4 which is to be monitored. • Format: 0x00nnhhhh (nn = node ID, hhhh = heartbeat time in [ms])
0x1017 (P522.00)	Producer heartbeat time (Prod. heartbeat) 0 ... [0] ... 65535 ms	Time interval for the transmission of the heartbeat telegram to the consumer(s). • The heartbeat telegram is sent automatically as soon as a time > 0 ms is set. • The set time is internally rounded up to the next multiple of 10 ms.

12.10.5.3 Error responses

The responses to CANopen errors such as missing PDOs or heartbeat frames can be configured via the following parameters.

Parameter

Address	Name / setting range / [default setting]	Information
0x1029:000	Error behavior: Highest sub-index supported • Read only	
0x1029:001	Error behavior: Communication error	Selection of the NMT state to which the inverter is to change automatically if a failure of a CANopen node or an internal error is detected in the "Operational" state. These also include the following communication errors: • Change-over of the CAN interface to the "Bus-off" state. • Occurrence of a "Heartbeat Event".
	0 Status > Pre-operational	In the "Pre-operational" state, network management, sync, and emergency telegrams as well as parameter data can be received; process data, however, are ignored.
	1 No status change	
	2 Status > Stopped	In the "Stopped" state, only network management telegrams can be received.
0x2857:001	CANopen monitoring: RPDO1-Timeout	Selection of the response to triggering the RPDO1 time monitoring. Associated error code: • 33425 0x8291 - CAN: RPDO1 time-out
	0 No response	▶ Error types 456
	1 Warning	
	2 Trouble	
0x2857:002	CANopen monitoring: RPDO2-Timeout	Selection of the response to triggering the RPDO2 time monitoring. Associated error code: • 33426 0x8292 - CAN: RPDO2 time-out
	0 No response	▶ Error types 456
	1 Warning	
	2 Trouble	
0x2857:003	CANopen monitoring: RPDO3-Timeout	Selection of the response to triggering the RPDO3 time monitoring. Associated error code: • 33427 0x8293 - CAN: RPDO3 time-out
	0 No response	▶ Error types 456
	1 Warning	
	2 Trouble	
0x2857:003	CANopen monitoring: RPDO3-Timeout	Selection of the response to triggering the RPDO3 time monitoring. Associated error code: • 33427 0x8293 - CAN: RPDO3 time-out
	0 No response	▶ Error types 456
	1 Warning	
	2 Trouble	
0x2857:003	CANopen monitoring: RPDO3-Timeout	Selection of the response to triggering the RPDO3 time monitoring. Associated error code: • 33427 0x8293 - CAN: RPDO3 time-out
	0 No response	▶ Error types 456
	1 Warning	
	2 Trouble	
0x2857:003	CANopen monitoring: RPDO3-Timeout	Selection of the response to triggering the RPDO3 time monitoring. Associated error code: • 33427 0x8293 - CAN: RPDO3 time-out
	0 No response	▶ Error types 456
	1 Warning	
	2 Trouble	
0x2857:003	CANopen monitoring: RPDO3-Timeout	Selection of the response to triggering the RPDO3 time monitoring. Associated error code: • 33427 0x8293 - CAN: RPDO3 time-out
	0 No response	▶ Error types 456
	1 Warning	
	2 Trouble	



Configuring the network

CANopen Monitoring

Address	Name / setting range / [default setting]	Information
0x2857:005	CANopen monitoring: Heartbeat-Timeout Consumer 1	
	Selection of the response with "Heartbeat Event" in consumer 1.	
	Associated error code: • 33156 0x8184 - CAN: heartbeat time-out consumer 1	
	0	No response ▶ Error types 456
	1	Warning
0x2857:006	CANopen monitoring: Heartbeat-Timeout Consumer 2	
	Selection of the response with "Heartbeat Event" in consumer 2.	
	Associated error code: • 33157 0x8185 - CAN: heartbeat time-out consumer 2	
	0	No response ▶ Error types 456
	1	Warning
0x2857:007	CANopen monitoring: Heartbeat-Timeout Consumer 3	
	Selection of the response with "Heartbeat Event" in consumer 3.	
	Associated error code: • 33158 0x8186 - CAN: heartbeat time-out consumer 3	
	0	No response ▶ Error types 456
	1	Warning
0x2857:008	CANopen monitoring: Heartbeat-Timeout Consumer 4	
	Selection of the response with "Heartbeat Event" in consumer 4.	
	Associated error code: • 33159 0x8187 - CAN: heartbeat time-out consumer 4	
	0	No response ▶ Error types 456
	1	Warning
0x2857:010	CANopen monitoring: "Bus-off" state change	
	Selection of the response to changing to the "Bus off" state.	
	Associated error code: • 33154 0x8182 - CAN: bus off	
	0	No response ▶ Error types 456
	1	Warning
0x2857:011	CANopen monitoring: Warning	
	Selection of the response that is executed in the case of too many incorrectly sent or received CAN telegrams (> 96).	
	Associated error code: • 33155 0x8183 - CAN: warning	
	0	No response ▶ Error types 456
	1	Warning
	2	Trouble
	3	Fault

Configuring the network

CANopen
Diagnostics





12.10.6 Diagnostics

12.10.6.1 LED status display

Information on the CAN bus status can be obtained quickly via the "BUS RDY" and "BUS ERR" LED displays on the front of the inverter.



The meaning can be seen from the tables below.

Inverter not active on the CAN bus (yet)



LED "BUS RDY"	LED "BUS ERR"	Meaning
off	off	Inverter is not active on the CAN bus.
	 on	"Bus Off" state.
 Both LEDs are flickering alternately		Automatic baud rate detection active.

Inverter active on the CAN bus

The green "BUS RDY" LED indicates the CANopen state:

LED "BUS RDY"	CANopen state
 blinking fast (5 Hz)	Pre-Operational
 on	Operational
 blinking 1x, then goes off for 1 s	Stopped

The red "BUS ERR" LED indicates a CANopen error:

LED "BUS ERR"	CANopen error
 blinking 1x, then goes off for 1 s	Warning Limit reached
 blinking 2x, then goes off for 1 s	Heartbeat Event
 blinking 3x, then goes off for 1 s	Sync message error (only possible in the "Operational" state)

12.10.6.2 Information on the network

The inverter has various diagnostic parameters for displaying ...

- the network status, the CAN master status and the status of various time monitors;
- telegram counters.

The telegram counters are free-running, i. e. after reaching the maximum value, the respective counter starts again at 0.

Parameter

Address	Name / setting range / [default setting]	Information
0x1001	Error register • Read only	Bit-coded error status. • Bit 0 is set if an error is active. The other bits signalise which group the active error belongs to: • Bit 1: Current error • Bit 2: Voltage error • Bit 3: Temperature error • Bit 4: Communication error • Bit 5: Device profile-specific error • Bit 6: Reserved (always 0) • Bit 7: Manufacturer-specific error
0x2302:001 (P511.01)	Active CANopen settings: Active node ID (CANopen diag.: Active node ID) • Read only	Display of the active node address.



Configuring the network

CANopen
Diagnostics

Address	Name / setting range / [default setting]	Information
0x2302:002 (P511.02)	Active CANopen settings: Active baud rate (CANopen diag.: Active baud rate) • Read only	Display of the active baud rate.
	0 Automatic (from version 03.00)	
	1 20 kbps	
	2 50 kbps	
	3 125 kbps	
	4 250 kbps	
	5 500 kbps	
	6 800 kbps	
7 1 Mbps		
0x2307 (P515.00)	CANopen time-out status (Time-out status) • Read only	Bit-coded status display of the CAN time monitoring functions.
	Bit 0 RPDO1-Timeout	1 = RPDO1 was not received within the monitoring time or not with the sync configured. • Status is reset automatically after the RPDO has been received again. • Setting of monitoring time for RPDO1 in 0x1400:005 (P540.05) .
	Bit 1 RPDO2-Timeout	1 = RPDO2 was not received within the monitoring time or not with the sync configured. • Status is reset automatically after the RPDO has been received again. • Setting of monitoring time for RPDO2 in 0x1401:005 (P541.05) .
	Bit 2 RPDO3-Timeout	1 = RPDO3 was not received within the monitoring time or not with the sync configured. • Status is reset automatically after the RPDO has been received again. • Setting of monitoring time for RPDO3 in 0x1402:005 (P542.05) .
	Bit 8 Heartbeat-Timeout Consumer 1	1 = within the "Heartbeat Consumer Time", no heartbeat telegram was received from node 1 to be monitored. • Status can only be reset by mains switching or error reset. • "Heartbeat Consumer Time" setting in 0x1016:001 (P520.01) .
	Bit 9 Heartbeat-Timeout Consumer 2	1 = within the "Heartbeat Consumer Time", no heartbeat telegram was received from node 2 to be monitored. • Status can only be reset by mains switching or error reset. • "Heartbeat Consumer Time" setting in 0x1016:002 (P520.02) .
	Bit 10 Heartbeat-Timeout Consumer 3	1 = within the "Heartbeat Consumer Time", no heartbeat telegram was received from node 3 to be monitored. • Status can only be reset by mains switching or error reset. • "Heartbeat Consumer Time" setting in 0x1016:003 (P520.03) .
	Bit 11 Heartbeat-Timeout Consumer 4	1 = within the "Heartbeat Consumer Time", no heartbeat telegram was received from node 4 to be monitored. • Status can only be reset by mains switching or error reset. • "Heartbeat Consumer Time" setting in 0x1016:004 (P520.04) .
0x2308 (P516.00)	CANopen status (CANopen status) • Read only	Display of the current state.
	0 Initialisation	Initialisation active. • The initialisation is started automatically at mains connection. During this phase, the inverter is not involved in the data exchange process on the CAN bus. • All CAN-relevant parameters are initialised with the saved settings. • When the initialisation process has been completed, the inverter automatically adopts the "Pre-Operational" state.
	1 Reset node	"Reset Node" NMT command active. • All parameters are initialised with the saved settings (not only the CAN-relevant parameters).
	2 Reset communication	"Reset Communication" NMT command active. • Initialisation of all CAN-relevant parameters with the values stored.
	4 Stopped	Only network management telegrams can be received.
	5 Operational	Parameter data and process data can be received. If defined, process data is sent as well.
	127 Pre-Operational	Parameter data can be received, process data are ignored.

Configuring the network

CANopen
Diagnostics



Address	Name / setting range / [default setting]	Information
0x2309 (P517.00)	CANopen controller status (CAN contr.status) • Read only	Status display of the internal CANopen controller.
	1 Error active	The inverter is a fully-fledged communication node at the CANopen network. It is able to transmit and receive data and to report faults.
	2 Error passive	The inverter can only passively indicate faulty reception via the ACK field.
	3 Bus off	The inverter is electrically separated from the CANopen network. In order to exit this state, the CANopen interface must be reset. An automatic restart is implemented.
0x230A:000	CANopen statistics: Highest subindex • Read only	Number of frame and error counters.
0x230A:001 (P580.01)	CANopen statistics: PDO1 received (CAN statistics: PDO1 received) • Read only	Display of the number of PDO1 telegrams received.
0x230A:002 (P580.02)	CANopen statistics: PDO2 received (CAN statistics: PDO2 received) • Read only	Display of the number of PDO2 telegrams received.
0x230A:003 (P580.03)	CANopen statistics: PDO3 received (CAN statistics: PDO3 received) • Read only	Display of the number of PDO3 telegrams received.
0x230A:005 (P580.05)	CANopen statistics: PDO1 transmitted (CAN statistics: PDO1 transmitted) • Read only	Display of the number of PDO1 telegrams sent.
0x230A:006 (P580.06)	CANopen statistics: PDO2 transmitted (CAN statistics: PDO2 transmitted) • Read only	Display of the number of PDO2 telegrams sent.
0x230A:007 (P580.07)	CANopen statistics: PDO3 transmitted (CAN statistics: PDO3 transmitted) • Read only	Display of the number of PDO3 telegrams sent.
0x230A:009 (P580.09)	CANopen statistics: SDO1 telegrams (CAN statistics: SDO1 counter) • Read only	Display of the number of SDO1 telegrams.
0x230A:010 (P580.10)	CANopen statistics: SDO2 telegrams (CAN statistics: SDO2 counter) • Read only	Display of the number of SDO2 telegrams.
0x230B (P518.00)	CANopen error counter (CAN errorcounter) • Read only	Display of the total number of CAN faults that have occurred.

12.10.6.3 Device identification

For device identification in the network, the inverter provides the parameters listed in the following.

Parameter

Address	Name / setting range / [default setting]	Information
0x1000	Device type • Read only	CANopen device profile according CANopen specification CiA 301/ CiA 402. Specifies the axis type: • 0x01010192 = single axis • 0x02010192 = double axis • 0x01020192 = servo single axis • 0x02020192 = servo double axis • 0x01030192 = stepper single axis • 0x02030192 = stepper double axis
0x1008	Manufacturer device name • Read only	Display of the manufacturer device name.
0x1009	Manufacturer hardware version • Read only	Display of the manufacturer hardware version.
0x100A	Manufacturer software version • Read only	Display of the manufacturer software version.
0x1018:001	Identity object: Vendor ID • Read only	Display of the manufacturer's identification number.



Configuring the network

CANopen
Diagnostics

Address	Name / setting range / [default setting]	Information
0x1018:002	Identity object: Product ID • Read only	Display of the product code of the inverter.
0x1018:003	Identity object: Revision number • Read only	Display of the main and subversion of the firmware.
0x1018:004	Identity object: Serial number • Read only	Display of the serial number of the inverter.

Configuring the network

Modbus RTU



12.11 Modbus RTU



Modbus is an internationally approved, asynchronous, serial communication protocol, designed for commercial and industrial automation applications.

- Detailed information on the Modbus can be found on the web page of the international Modbus Organization, USA, who also further develop the Modbus protocol: <http://www.modbus.org>
- Information about the dimensioning of a Modbus network can be found in the configuration document for the inverter.

Details

- The process of data transmission distinguishes between three different operating modes: Modbus ASCII, Modbus RTU, and Modbus TCP. This chapter describes the Modbus RTU operating mode ("Remote Terminal Unit").
- The Modbus protocol is based on a master/slave architecture where the inverter always works as slave.
- The Modbus network only permits one master sending commands and requests. The master is also the sole instance to be allowed to initiate Modbus communication. No direct communication takes place between the slaves.
- The physical interface corresponds to TIA/EIA-485-A which is very common and suitable for the industrial environment. This interface enables baud rates from 2400 to 115200 kbps.
- The inverter supports Modbus function codes 3, 6, 16 (0x10) and 23 (0x17).

Typical topology

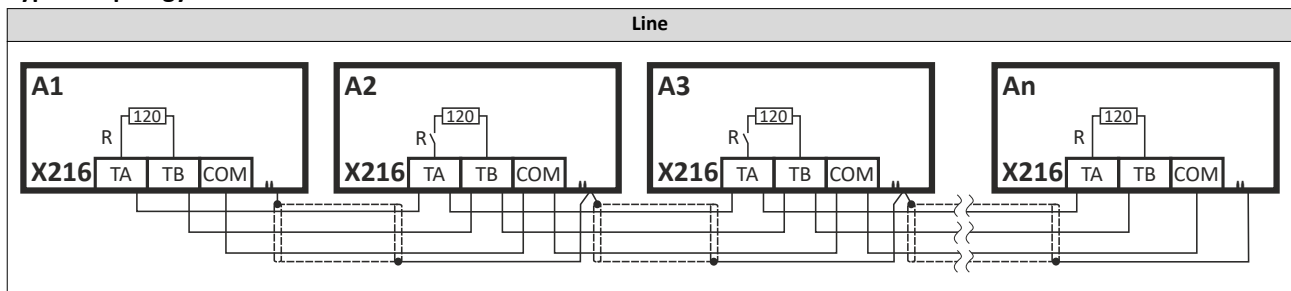



12.11.1 Commissioning

In the following, the steps required for controlling the inverter via Modbus are described.

Parameterization required

1. Activate network control: `0x2631:037 (P400.37) = "TRUE [1]"`
2. Set network as standard setpoint source: `0x2860:001 (P201.01) = "Network [5]"`
3. Set Modbus node address.
 - Each network node must be provided with a unique node address.
 - See: [Basic setting and options](#) 335
4. Set Modbus baud rate.
 - Default setting: Automatic detection.
 - If the automatic baud rate detection function is activated, the first 5 to 10 messages are lost after switch-on.
 - See: [Basic setting and options](#) 335
5. Set Modbus data format.
 - Default setting: Automatic detection.
 - If the automatic data format detection function is activated, the first 5 to 10 messages are lost after switch-on.
 - See: [Basic setting and options](#) 335
6. Save parameter settings: `0x2022:003 (P700.03) = "on / start [1]"`.
7. Switch the inverter off and then on again in order that the changed communication settings can get effective.



In the default setting, the "Run" function is assigned to digital input DI1. If network control is activated, this function serves as the "start enable" for starting commands via the network. Hence, digital input DI1 must be set to the HIGH level so the motor can be started via the network.

[Flexible I/O configuration of the start, stop and rotating direction commands](#) 54

Starting/stopping the drive via Modbus

For starting/stopping the drive, Modbus register 42101 can be used.

- The Modbus register 42101 is permanently assigned to the parameter `0x400B:001 (P592.01)` (AC Drive control word).
- In the frame, the leading 4 is omitted in the addressing process. The numbering of the registers starts with 1; addressing, however, starts with 0. Therefore the address 2100 (0x0834) is used in the frame when register 42101 is written.

Bits set in the AC Drive control word:

- Bit 0 = Run forward (CW)
- Bit 5 = Activate network control
- Bit 6 = Activate network setpoint

Example of an inverter with the node address 1:

Request frame by the master					
Slave address	Function code	Data			
		Register address		AC Drive control word	
0x01	0x06	0x08	0x34	0x00	0x61

If the digital input DI1 ("Start enable") is set to HIGH level, the drive should start and the inverter should respond with the same frame as confirmation:

Response message from the inverter					
Slave address	Function code	Data			
		Register address		AC Drive control word	
0x01	0x06	0x08	0x34	0x00	0x61

Configuring the network

Modbus RTU
Commissioning



Write the speed of the drive via Modbus

The drive speed can be changed via the modbus register 42102, see:

▶ [Data mapping](#) 339

Example of an inverter with the node address 1:

Request frame by the master					
Slave address	Function code	Data			
		Register address		Network setpoint frequency (0.01)	
0x01	0x06	0x08	0x35	0x04	0xD2

Response message from the inverter					
Slave address	Function code	Data			
		Register address		Network setpoint frequency (0.01)	
0x01	0x06	0x08	0x35	0x04	0xD2

The drive now rotates with a frequency of 12.34 Hz.

Read the drive speed via Modbus

The drive speed can be read via the Modbus register 42002, see:

▶ [Data mapping](#) 339

The function code 3 is used to read a single register or several interrelated register blocks, see:

▶ [Function codes](#) 337

Example of an inverter with the node address 1:

Request frame by the master					
Slave address	Function code	Data			
		Register address		Number of words	
0x01	0x03	0x07	0xD1	0x00	0x01

Response message from the inverter					
Slave address	Function code	Data			
		Read bytes		Frequency (0.01)	
0x01	0x03	0x02	0x04	0xD1	

The drive rotates with a frequency of 12.33 Hz.

Restart of the communication

A restart of communication is required after changes of the interface configuration (e. g. node address and baud rate) in order that the changed settings become effective.

For restarting communication, there are two options:

- Switch inverter off and on again.
- 0x2320 (P508.00) Set = "Restart with current values [1]".

Parameter

Address	Name / setting range / [default setting]	Information
0x2320 (P508.00)	Modbus communication (Modbus comm.)	1 = restart communication in order that changed settings of the interface configuration become effective.
	0 No action/no error	
	1 Restart with current values	



12.11.2 Basic setting and options

12.11.2.1 Node address setting

Each network node must be provided with a unique node address.

- The node address can be set in [0x2321:001 \(P510.01\)](#).
- The setting that is active when the inverter is switched on is the effective setting.
- The node address 0 is reserved for messages to all nodes ("Broadcast").
- The active node address is shown in [0x2322:001 \(P511.01\)](#).

Parameter

Address	Name / setting range / [default setting]	Information
0x2321:001 (P510.01)	Modbus settings: Node ID (Modbus sett.: Node ID) 1 ... [1] ... 247	Setting of the node address. <ul style="list-style-type: none"> • A change in the node address only becomes effective after a restart of Modbus communication.

12.11.2.2 Baud rate setting

All network nodes must be set to the same baud rate.

Parameter

Address	Name / setting range / [default setting]	Information
0x2321:002 (P510.02)	Modbus settings: Baud rate (Modbus sett.: Baud rate)	Setting of the baud rate. <ul style="list-style-type: none"> • A change in the baud rate only becomes effective after a restart of Modbus communication. • If the automatic baud rate detection function is activated, the first 5 ... 10 messages are lost after switch-on.
	0 Automatic	
	1 2400 bps	
	2 4800 bps	
	3 9600 bps	
	4 19200 bps	
	5 38400 bps	
	6 57600 bps	
7 115200 bps		

12.11.2.3 Data format setting

All network nodes must be set to the same data format.

- The data format can be set in [0x2321:003 \(P510.03\)](#).
- If the automatic data format detection function is activated, the first 5 ... 10 messages are lost after switch-on.
- The active data format is displayed in [0x2322:003 \(P511.03\)](#).

Parameter

Address	Name / setting range / [default setting]	Information
0x2321:003 (P510.03)	Modbus settings: Data format (Modbus sett.: Data format)	Definition of the parity and stop bits.
	0 Automatic	Automatic data format detection. <ul style="list-style-type: none"> • With this setting, the first 5 ... 10 messages are lost after switch-on.
	1 8, E, 1	8 data bits, even parity, 1 stop bit
	2 8, O, 1	8 data bits, odd parity, 1 stop bit
	3 8, N, 2	8 data bits, no parity bit, 2 stop bits
	4 8, N, 1	8 data bits, no parity bit, 1 stop bit

12.11.2.4 Minimum response time setting

Some Modbus masters have issues turning around their transceiver at higher baud rates. To resolve integration issues the user may use Modbus: Minimum Response Time (0x2321:004) to set a minimum time delay to be observed between the receipt of a valid Modbus message and the drive's response. Time is entered in milliseconds [0x2321:004 \(P510.04\)](#).

Parameter

Address	Name / setting range / [default setting]	Information
0x2321:004 (P510.04)	Modbus settings: Minimum response time (Modbus sett.: Min. resp. time) 0 ... [0] ... 1000 ms	Minimum time delay between the reception of a valid message and the response of the drive.

Configuring the network

Modbus RTU
Data transfer



12.11.3 Data transfer

The mode of access to inverter data (parameters) is controlled via function codes.



12.11.3.1 Function codes

The inverter supports the following function codes:

Function code		Function name	Description
3	0x03	Read Holding Registers	Read one or more 16-bit data words.
6	0x06	Preset Single Register	Write a 16-bit data word.
16	0x10	Preset Multiple Registers	Write one or more 16-bit data words.
23	0x17	Read/Write 4X Registers	Within a transaction <ul style="list-style-type: none"> • write into a group of connected 4X holding registers. • read from a group of connected 4X holding registers.

Addressing

- The function codes listed above exclusively refer to 4X registers in Modbus addressing.
- All data in the inverter can only be accessed via 4X registers, i.e. via register addresses from 40001.
- The 4xxx reference is implicit, i. e. given by the function code used. In the frame therefore the leading 4 is omitted in the addressing process.
- Lenze supports the basic 1 addressing of Modbus, i.e. the numbering of the registers starts with 1 whereas addressing starts with 0. For example, the address 0 is used in the frame when register 40001 is read.

Frame structure

Communication is established on the basis of the central medium access method.

Communication is always started by a master request. The inverter (slave) then either gives a valid response or outputs an error code (provided that the request has been received and evaluated as a valid Modbus frame). Error causes can be invalid CRC checksums, function codes that are not supported, or impermissible data access.

All Modbus frames have the following basic structure:

- A "frame" consists of a PDU (Protocol Data Unit) and an ADU (Application Data Unit).
- The PDU contains the function code and the data belonging to the function code.
- The ADU serves the purposes of addressing and error detection.
- The data are represented in Big Endian format (most significant byte first).

ADU (Application Data Unit)			
Slave address	Function code	Data	Checksum (CRC)
	PDU (Protocol Data Unit)		

Configuring the network

Modbus RTU
Data transfer



Error codes

In the event of an error, the Modbus node responds with a function code associated with the message:

Function code	Associated function code in the event of an error	Supported error codes
0x03	0x83	0x01, 0x02, 0x03, 0x04
0x06	0x86	0x01, 0x02, 0x03, 0x04
0x10	0x90	0x01, 0x02, 0x03, 0x04
0x17	0x97	0x01, 0x02, 0x03, 0x04

Error code	Designation	Cause(s)
0x01	Invalid function code	The function code is not supported by the inverter, or the inverter is in a state in which the request is not permissible or in which it cannot be processed.
0x02	Invalid data address	The combination of a start address and the length of the data to be transmitted is invalid. Example: If you have a slave with 100 registers, the first register has the address 0 and the last register has the address 99. If there is a request of four registers now, from the start address 96, the request can be processed successfully (for registers 96, 97, 98, and 99). If, however, five registers from the start address 96 are queried, this error code is returned, since the slave has no register with the address 100.
0x03	Invalid data value	Error in the reset structure of a complex request, e. g. because the data length that has resulted implicitly is not correct. The cause, however, is not that a (parameter) value is written outside the valid setting range. As a matter of principle, the Modbus protocol has no information on valid setting ranges of single registers or their meaning.
0x04	Slave device failure	A non-correctable error has occurred while the request was processed in the inverter.



12.11.3.2 Data mapping

The process of data mapping is used for defining which Modbus registers read or write to which inverter parameters.

- There are pre-defined Modbus registers for common control and status words, which are located in coherent blocks, in order to facilitate communication with OPC servers and other Modbus masters. In order to access all relevant data of the inverter, only a minimum number of commands is required.
- In addition, 24 registers are provided for variable mapping, i. e. free assignment to inverter parameters.

Predefined Modbus control registers

- These registers are provided with write and read access.
- The cross-reference in column 2 leads to the detailed parameter description.

Modbus registers	Permanently assigned parameter	
	Address	Designation
42101	0x400B:001 (P592.01)	AC Drive control word
42102	0x400B:005 (P592.05)	Network setpoint frequency (0.01)
42103	0x4008:002 (P590.02)	NetWordIN2
42104	0x4008:003 (P590.03)	NetWordIN3
42105	0x400B:007 (P592.07)	PID setpoint
42106	0x6071	Set torque
42107	0x4008:001 (P590.01)	NetWordIN1
42108	0x4008:004 (P590.04)	NetWordIN4
42109 ... 42121	-	Reserved

Predefined Modbus status registers

- These registers are only provided with read access.
- The cross-reference in column 2 leads to the detailed parameter description.

Modbus registers	Permanently assigned parameter	
	Address	Designation
42001	0x400C:001 (P593.01)	AC Drive status word
42002	0x400C:006 (P593.06)	Frequency (0.01)
42003	0x603F (P150.00)	Error code
42004	0x400C:005 (P593.05)	Drive status
42005	0x2D89 (P106.00)	Motor voltage
42006	0x2D88 (P104.00)	Motor current
42007	0x6078 (P103.00)	Actual current
42008	0x2DA2:002 (P108.02)	Apparent power (42008 = High Word, 42009 = Low Word)
42009		
42010	0x2D84:001 (P117.01)	Heatsink temperature
42011	0x2D87 (P105.00)	DC-bus voltage
42012	0x60FD (P118.00)	Digital input status (only bit 16 ... bit 31)
42013	0x6077 (P107.00)	Actual torque
42014 ... 42021	-	Reserved

Configuring the network

Modbus RTU
Monitoring



Variable mapping

- Via **0x232B:001 ... 0x232B:024 (P530.01 ... 24)**, 24 registers can be mapped to parameters of the inverter. Format:
0xiiii:ss00
(iiii = index hexadecimal,
ss = subindex hexadecimal)
- The display of the internal Modbus register numbers in **0x232C:001 ... 0x232C:024 (P531.01 ... 24)** is generated automatically. Since 32-bit parameters require two registers, there is no 1:1 assignment.
- For the mappable registers, a CRC (Cyclic Redundancy Check) is executed. The checksum determined is displayed in **0x232D (P532.00)**. The user can read this "validation code" and use it for comparison in the Modbus master. In this way it can be checked whether the inverter currently queried is configured correctly for the respective application.

Parameter

Address	Name / setting range / [default setting]	Information
0x232B:001 ... 0x232B:024 (P530.01 ... 24)	Modbus parameter mapping: Parameter 1 ... Parameter 24 (Para. mapping: Parameter 1 ... Parameter 24) 0x00000000 ... [0x00000000] ... 0xFFFFF00	Mapping entries for the variable mapped Modbus registers. • Format: 0xiiii:ss00 (iiii = index, ss = subindex)
0x232C:001 ... 0x232C:024 (P531.01 ... 24)	Modbus register assignment: Register 1 ... Register 24 (Reg. assigned: Register 1 ... Register 24) • Read only	Display of the internal Modbus register number starting from which the parameter mapped in 0x232B:001 ... 0x232B:024 (P530.01 ... 24) is stored. • For the first parameter mapped, always 2500. • From the second parameter mapped, 2500 + offset. The offset results from the data types of the previously mapped parameters.
0x232D (P532.00)	Modbus verification code (Verificationcode) • Read only	

12.11.4 Monitoring

Time-out monitoring

The response to the missing Modbus messages can be configured via the following parameters.

Parameter

Address	Name / setting range / [default setting]	Information
0x2858:001 (P515.01)	Modbus monitoring: Response to time-out (Modbus monit.: Resp. Time-out)	Selection of the response executed if no valid messages have been received via the Modbus for a longer time than the time-out period set in 0x2858:002 (P515.02) . Associated error code: • 33185 0x81A1 - Modbus: network time-out
	0 No response	▶ Error types 456
	1 Warning	
	2 Trouble	
3 Fault		
0x2858:002 (P515.02)	Modbus monitoring: Time-out time (Modbus monit.: Time-out time) 0.0 ... [2.0] ... 300.0 s	Time-out period for monitoring the message reception via Modbus.





12.11.5 Diagnostics

12.11.5.1 LED status display

Information on the Modbus status can be obtained quickly via the "BUS RDY" and "BUS ERR" LED displays on the front of the inverter.

The meaning can be seen from the tables below.

Inverter not active on the Modbus bus (yet)

LED "BUS RDY"	LED "BUS ERR"	Meaning
off	 on	Internal error
	Both LEDs are flickering alternately	Automatic detection of baud rate and data format active.

Inverter active on the Modbus

The green "BUS RDY" LED indicates the communication status:

LED "BUS RDY"	Communication status
off	No reception / no transmission
 on	Reception / transmission active

The red "BUS ERR" LED indicates an error:

LED "BUS ERR"	Fault
off	No fault
 blinking	Communication error

12.11.5.2 Information on the network

The following parameters serve to diagnose the communication activities between the inverter and the Modbus network.

Parameter

Address	Name / setting range / [default setting]	Information
0x2322:001 (P511.01)	Active Modbus settings: Active node ID (Modbus diag.: Active node ID) • Read only	Display of the active node address.
0x2322:002 (P511.02)	Active Modbus settings: Active baud rate (Modbus diag.: Active baud rate) • Read only	Display of the active baud rate.
	0 Automatic	Setting of the baud rate.
	1 2400 bps	<ul style="list-style-type: none"> A change in the baud rate only becomes effective after a restart of Modbus communication. If the automatic baud rate detection function is activated, the first 5 ... 10 messages are lost after switch-on.
	2 4800 bps	
	3 9600 bps	
	4 19200 bps	
	5 38400 bps	
	6 57600 bps	
7 115200 bps		
0x2322:003 (P511.03)	Active Modbus settings: Data format (Modbus diag.: Data format) • Read only	Display of the active data format.
	0 Automatic	Automatic data format detection. • With this setting, the first 5 ... 10 messages are lost after switch-on.
	1 8, E, 1	8 data bits, even parity, 1 stop bit
	2 8, O, 1	8 data bits, odd parity, 1 stop bit
	3 8, N, 2	8 data bits, no parity bit, 2 stop bits
4 8, N, 1	8 data bits, no parity bit, 1 stop bit	
0x232A:001 (P580.01)	Modbus statistics: Messages received (Modbus statistic: Mess. received) • Read only	Display of the total number of messages received. • This counter counts both valid and invalid messages. • After the maximum value has been reached, the counter starts again "0".

Configuring the network

Modbus RTU
Diagnostics



Address	Name / setting range / [default setting]	Information
0x232A:002 (P580.02)	Modbus statistics: Valid messages received (Modbus statistic: Val. mess. rec.) <ul style="list-style-type: none">• Read only	Display of the number of valid messages received. <ul style="list-style-type: none">• After the maximum value has been reached, the counter starts again "0".
0x232A:003 (P580.03)	Modbus statistics: Messages with exceptions (Modbus statistic: Mess. w. exc.) <ul style="list-style-type: none">• Read only	Display of the number of messages with exceptions that have been received. <ul style="list-style-type: none">• After the maximum value has been reached, the counter starts again "0".
0x232A:004 (P580.04)	Modbus statistics: Messages with errors (Modbus statistic: Mess. w. errors) <ul style="list-style-type: none">• Read only	Display of the number of messages received with a faulty data integrity (parity, CRC). <ul style="list-style-type: none">• After the maximum value has been reached, the counter starts again "0".
0x232A:005 (P580.05)	Modbus statistics: Messages sent (Modbus statistic: Messages sent) <ul style="list-style-type: none">• Read only	Display of the total number of messages sent. <ul style="list-style-type: none">• After the maximum value has been reached, the counter starts again "0".
0x232E:001 (P583.01)	Modbus diagnostics of last Rx data: Offset (Rx data diagn.: Rx data offset) 0 ... [0] ... 240	For purposes of diagnostics, the last message received (max. 16 bytes) is shown in 0x232E:002 (P583.02) ... 0x232E:017 (P583.17) . For longer messages, an offset can be specified here, indicating from which byte of the message the display of the 16 bytes is to start.



Configuring the network

Modbus RTU
Diagnostics

Address	Name / setting range / [default setting]	Information
0x232E:002 (P583.02)	Modbus diagnostics of last Rx data: Data byte 0 (Rx data diagn.: Last RxD byte0) • Read only	Display of the message received last.
0x232E:003 (P583.03)	Modbus diagnostics of last Rx data: Data byte 1 (Rx data diagn.: Last RxD byte1) • Read only	
0x232E:004 (P583.04)	Modbus diagnostics of last Rx data: Data byte 2 (Rx data diagn.: Last RxD byte2) • Read only	
0x232E:005 (P583.05)	Modbus diagnostics of last Rx data: Data byte 3 (Rx data diagn.: Last RxD byte3) • Read only	
0x232E:006 (P583.06)	Modbus diagnostics of last Rx data: Data byte 4 (Rx data diagn.: Last RxD byte4) • Read only	
0x232E:007 (P583.07)	Modbus diagnostics of last Rx data: Data byte 5 (Rx data diagn.: Letzt RxD-Byte5) • Read only	
0x232E:008 (P583.08)	Modbus diagnostics of last Rx data: Data byte 6 (Rx data diagn.: Last RxD byte6) • Read only	
0x232E:009 (P583.09)	Modbus diagnostics of last Rx data: Data byte 7 (Rx data diagn.: Last RxD byte7) • Read only	
0x232E:010 (P583.10)	Modbus diagnostics of last Rx data: Data byte 8 (Rx data diagn.: Last RxD byte8) • Read only	
0x232E:011 (P583.11)	Modbus diagnostics of last Rx data: Data byte 9 (Rx data diagn.: Last RxD byte9) • Read only	
0x232E:012 (P583.12)	Modbus diagnostics of last Rx data: Data byte 10 (Rx data diagn.: Last RxD byte10) • Read only	
0x232E:013 (P583.13)	Modbus diagnostics of last Rx data: Data byte 11 (Rx data diagn.: Last RxD byte11) • Read only	
0x232E:014 (P583.14)	Modbus diagnostics of last Rx data: Data byte 12 (Rx data diagn.: Last RxD byte12) • Read only	
0x232E:015 (P583.15)	Modbus diagnostics of last Rx data: Data byte 13 (Rx data diagn.: Last RxD byte13) • Read only	
0x232E:016 (P583.16)	Modbus diagnostics of last Rx data: Data byte 14 (Rx data diagn.: Last RxD byte14) • Read only	
0x232E:017 (P583.17)	Modbus diagnostics of last Rx data: Data byte 15 (Rx data diagn.: Last RxD byte15) • Read only	
0x232F:001 (P585.01)	Modbus diagnostics of last Tx data: Offset (Tx data diagn.: Tx data offset) 0 ... [0] ... 240	For purposes of diagnostics, the last message sent (max. 16 bytes) is shown in 0x232F:002 (P585.02) ... 0x232F:017 (P585.17) . For longer messages, an offset can be specified here, indicating from which byte of the message the display of the 16 bytes is to start.

Configuring the network

Modbus RTU Diagnostics



Address	Name / setting range / [default setting]	Information
0x232F:002 (P585.02)	Modbus diagnostics of last Tx data: Data byte 0 (Tx data diagn.: Last TxD byte0) <ul style="list-style-type: none">• Read only	Display of the message sent last.
0x232F:003 (P585.03)	Modbus diagnostics of last Tx data: Data byte 1 (Tx data diagn.: Last TxD Byte1) <ul style="list-style-type: none">• Read only	
0x232F:004 (P585.04)	Modbus diagnostics of last Tx data: Data byte 2 (Tx data diagn.: Last TxD byte2) <ul style="list-style-type: none">• Read only	
0x232F:005 (P585.05)	Modbus diagnostics of last Tx data: Data byte 3 (Tx data diagn.: Last TxD byte3) <ul style="list-style-type: none">• Read only	
0x232F:006 (P585.06)	Modbus diagnostics of last Tx data: Data byte 4 (Tx data diagn.: Last TxD byte4) <ul style="list-style-type: none">• Read only	
0x232F:007 (P585.07)	Modbus diagnostics of last Tx data: Data byte 5 (Tx data diagn.: Last TxD byte5) <ul style="list-style-type: none">• Read only	
0x232F:008 (P585.08)	Modbus diagnostics of last Tx data: Data byte 6 (Tx data diagn.: Last TxD byte6) <ul style="list-style-type: none">• Read only	
0x232F:009 (P585.09)	Modbus diagnostics of last Tx data: Data byte 7 (Tx data diagn.: Last TxD byte7) <ul style="list-style-type: none">• Read only	
0x232F:010 (P585.10)	Modbus diagnostics of last Tx data: Data byte 8 (Tx data diagn.: Last TxD byte8) <ul style="list-style-type: none">• Read only	
0x232F:011 (P585.11)	Modbus diagnostics of last Tx data: Data byte 9 (Tx data diagn.: Last TxD byte9) <ul style="list-style-type: none">• Read only	
0x232F:012 (P585.12)	Modbus diagnostics of last Tx data: Data byte 10 (Tx data diagn.: Last TxD byte10) <ul style="list-style-type: none">• Read only	
0x232F:013 (P585.13)	Modbus diagnostics of last Tx data: Data byte 11 (Tx data diagn.: Last TxD byte11) <ul style="list-style-type: none">• Read only	
0x232F:014 (P585.14)	Modbus diagnostics of last Tx data: Data byte 12 (Tx data diagn.: Last TxD byte12) <ul style="list-style-type: none">• Read only	
0x232F:015 (P585.15)	Modbus diagnostics of last Tx data: Data byte 13 (Tx data diagn.: Last TxD byte13) <ul style="list-style-type: none">• Read only	
0x232F:016 (P585.16)	Modbus diagnostics of last Tx data: Data byte 14 (Tx data diagn.: Last TxD byte14) <ul style="list-style-type: none">• Read only	
0x232F:017 (P585.17)	Modbus diagnostics of last Tx data: Data byte 15 (Tx data diagn.: Last TxD byte15) <ul style="list-style-type: none">• Read only	



13 Device functions

13.1 Optical device identification

For applications including several interconnected inverters it may be difficult to locate a device that has been connected online. The "Optical device identification" function serves to locate the inverter by means of blinking LEDs.

Details

In order to start the visual tracking,

- click the button in the toolbar of the »EASY Starter«  or
- set `0x2021:001 (P230.01)` = "Start [1]".

After the start, both LEDs "RDY" and "ERR" on the front of the inverter synchronously blink very fast.

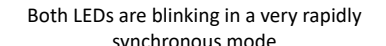
"RDY" LED (blue)	"ERR" LED (red)	Status/meaning
		"Visual tracking" function is active.
Both LEDs are blinking in a very rapidly synchronous mode		

The blinking duration can be set in `0x2021:002 (P230.02)` or selected in the »EASY Starter« in the dropdown list field:

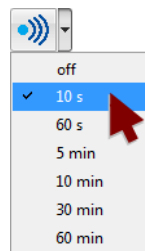

Parameter

Address	Name / setting range / [default setting]	Information		
0x2021:001 (P230.01)	Optical tracking: Start detection (Optical tracking: Start detection)	1 = start optical device identification. <ul style="list-style-type: none"> • After the start, the two LEDs "RDY" and "ERR" on the front of the inverter are blinking with a blinking frequency of 20 Hz for the blinking duration set in <code>0x2021:002 (P230.02)</code>. The setting is then automatically reset to "0" again. • If the function is reactivated within the blinking time set, the time is extended correspondingly. • A manual reset to "0" makes it possible to stop the function prematurely. 		
	<table border="1"> <tr> <td>0</td> <td>Stop</td> </tr> <tr> <td>1</td> <td>Start</td> </tr> </table>		0	Stop
0	Stop			
1	Start			
0x2021:002 (P230.02)	Optical tracking: Blinking duration (Optical tracking: Blink. duration) 0 ... [5] ... 3600 s	Setting of the blinking duration for the visual tracking.		



13.2 Reset parameters to default

With the "Load default settings" device command, all parameters can be reset to the default setting.



By executing this device command, all parameter settings made by the user are lost!

Details

- All current parameters in the RAM memory of the device are overwritten by the default parameters stored in the firmware. The persistent parameters in the memory module remain unaffected by this measure.

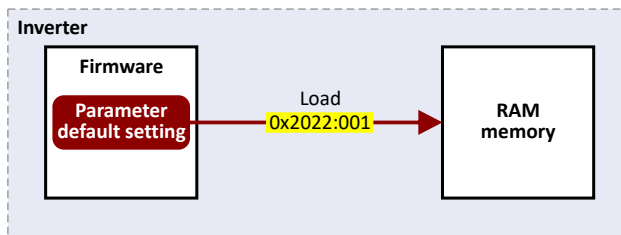

- Afterwards, the device can be parameterized again on the basis of this initial state.
- Typical application: Incorrect or unknown parameter settings.
- The device command only has an effect on the RAM. For a permanent acceptance of the changes made, the data must subsequently be saved in memory. [▶ Saving/loading the parameter settings](#) □ 348

Parameter

Address	Name / setting range / [default setting]	Information	
0x2022:001 (P700.01)	Device commands: Load default settings (Device commands: Load def. sett.)	1 = reset all parameters in the RAM memory of the inverter to the default setting that is stored in the inverter firmware. <ul style="list-style-type: none"> All parameter changes made by the user are lost during this process! It may take some seconds to execute the task. When the task has been executed successfully, the value 0 is shown. Loading parameters has a direct effect on the cyclic communication: The data exchange for control is interrupted and a communication error is generated. 	
	• Setting can only be changed if the inverter is disabled.		
	0 Off / ready		Only status feedback
	1 On / start		Execute device command
	2 In progress		Only status feedback
	3 Action cancelled		
	4 No access		
5 No access (Device disabled)			



13.2.1 Configure reset behaviour

For some customers it is a common method to always have the same starting conditions of the parameters.

This function allows a user to exclude certain parameter groups from being reset to the default settings using the "Load default settings" device command.

Details

By default, all parameters are reset when the default settings are loaded.

▶ [0x2022:001 \(P700.01\)](#)

The user can reconfigure this function.

▶ [0x2024:001](#)

Thus, certain parameter groups can be excluded.

The following cannot be selected for the reset:

- address of the communication bus,
- data format,
- baud rate,
- subnet mask,

and for WLAN:

- channel,
- safety,
- network password,
- SSID name.

Your setting values remain stored.

Please make sure that bit 0 must be set to 1 in the parameter [0x2024:001](#) before executing the default settings in order that the network parameters are excluded from the reset.

Note that the purpose of this function is to enable the master to restore the connection to an inverter after loading the default settings. Because all data mapping and functional settings are reset, the user must let the master reconfigure the settings of the inverter before it operates the inverter.

Parameter

Address	Name / setting range / [default setting]	Information
0x2024:001	Special settings: Configure default setting 0 ... [0] ... 65535	By default, all parameters are reset when the default settings are loaded (0x2022: 001). The user has the option of reconfiguring this function with the parameter. This allows certain parameter groups to be excluded.
	Bit 0 Exclude network	TRUE: Exclusion of the network parameters (address of the communication bus, the data format, the baud rate, the subnet mask, and for WLAN, channel, security, network password and SSID name).
	Bit 1 Exclude internal registers	

Device functions

Saving/loading the parameter settings



13.3 Saving/loading the parameter settings

If parameter settings of the inverter are changed, these changes at first are only made in the RAM memory of the inverter. In order to save the parameter settings with mains failure protection, the inverter is provided with a pluggable memory module and corresponding device commands.

Details

The memory module is provided with two memories, the user memory and the OEM memory.

User memory

The user memory is used as power-failure-proof storage of parameter settings made by the user during commissioning/operation.

- The SET display blinks on the keypad if a parameter setting has been changed but has not been saved in the memory module with mains failure protection. In order to save parameter settings in the user memory of the memory module, press and hold the enter key for longer than 3 s.

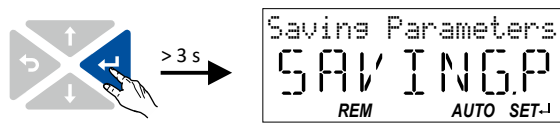

- Parameter settings carried out with »EASY Starter« or via network must be explicitly saved in the user memory by means of the "Save user data" device command, so that the changes carried out are not lost when the mains of the inverter are switched.
- Saving can also be made in the »EASY Starter« via the button  or the <F6> function key.
- The device command "Load user data" serves to reload the data from the user memory into the RAM.

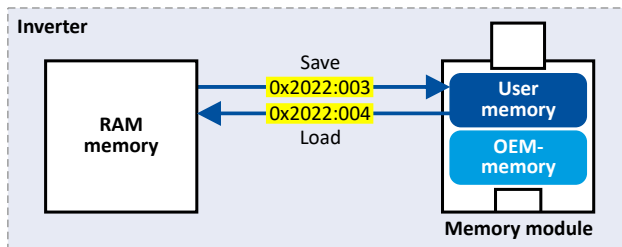

OEM memory

The OEM memory is provided for the storage of customised parameter settings by the OEM/ engineer. If the user carries out parameter settings with the keypad, they are always saved in the user memory if the enter key is pressed and held for longer than 3 s. The OEM memory remains unaffected by these changes.

- With the "Load OEM data" device command, the parameter settings preconfigured by the OEM/ engineer can be reloaded to the RAM memory of the inverter at any time if required.
- For saving parameter settings in the OEM memory, the "Save OEM data" device command must be executed explicitly. The parameter settings are simultaneously saved in the user memory.

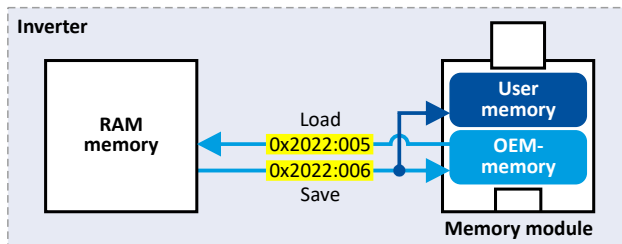



Response after initial switch-on of the inverter

After switch-on, the inverter first tries to load the parameter settings stored in the user memory. If the user memory is empty or damaged, an error message is output and the user must intervene:

- Case 1 = user memory empty: → default setting is loaded automatically from the firmware → data are saved automatically in the user memory of the memory module.
- Case 2 = user memory damaged: → Error message → default setting is loaded automatically → data are saved automatically in the user memory of the memory module.
- Case 3 = OEM memory empty/damaged: → error message → data are loaded automatically from the user memory of the memory module.

Parameter

Address	Name / setting range / [default setting]	Information
0x2022:003 (P700.03)	Device commands: Save user data (Device commands: Save user data)	1 = save current parameter settings in the user memory of the memory module with mains failure protection. <ul style="list-style-type: none"> • This process may take some seconds. When the device command has been executed successfully, the value 0 is shown. • Do not switch off the supply voltage during the saving process and do not unplug the memory module from the device! • When the device is switched on, all parameters are automatically loaded from the user memory of the memory module to the RAM memory of the device.
	0 Off / ready	Only status feedback
	1 On / start	Execute device command
	2 In progress	Only status feedback
	3 Action cancelled	
	4 No access	
5 No access (Device disabled)		
0x2022:004 (P700.04)	Device commands: Load user data (Device commands: Load user data) <ul style="list-style-type: none"> • Setting can only be changed if the inverter is disabled. 	1 = load data from the user memory of the memory module to the RAM memory of the inverter. <ul style="list-style-type: none"> • When the device command has been executed successfully, the value 0 is shown. • Loading parameters has a direct effect on the cyclic communication: The data exchange for control is interrupted and a communication error is generated.
	0 Off / ready	Only status feedback
	1 On / start	Execute device command
	2 In progress	Only status feedback
	3 Action cancelled	
	4 No access	
5 No access (Device disabled)		
0x2022:005 (P700.05)	Device commands: Load OEM data (Device commands: Load OEM data) <ul style="list-style-type: none"> • Setting can only be changed if the inverter is disabled. 	1 = load data from the OEM memory of the memory module to the RAM memory of the inverter. <ul style="list-style-type: none"> • When the device command has been executed successfully, the value 0 is shown. • Loading parameters has a direct effect on the cyclic communication: The data exchange for control is interrupted and a communication error is generated.
	0 Off / ready	Only status feedback
	1 On / start	Execute device command
	2 In progress	Only status feedback
	3 Action cancelled	
	4 No access	
5 No access (Device disabled)		

Device functions

Saving/loading the parameter settings



Address	Name / setting range / [default setting]	Information
0x2022:006 (P700.06)	Device commands: Save OEM data (Device commands: Save OEM data)	1 = save current parameter settings in the OEM memory of the memory module with mains failure protection. <ul style="list-style-type: none">• At the same time, the parameter settings are saved in the main memory of the memory module.• When the device command has been executed successfully, the value 0 is shown.
	0 Off / ready	Only status feedback
	1 On / start	Execute device command
	2 In progress	Only status feedback
	3 Action cancelled	
	4 No access	
5 No access (Device disabled)		

Related topics

- ▶ [Behaviour of the inverter in case of incompatible data in the memory module](#)  364



13.4 Access protection

13.4.1 Write access protection

Optionally a write access protection can be installed for the inverter parameters.



Write access protection only restricts parameterisation via keypad and »EASY Starter«. Write access protection via network is not restricted. Irrespective of the write access protection that is currently set, a higher-level controller, OPC-UA server, or any other communication partner connected to the inverter is always provided with full read/write access to all parameters of the inverter.



After activating the write access protection, you have to enter a valid PIN to remove the write access protection. Note down the defined PIN(s) and keep this information in a safe place! If you lose the PIN(s), the inverter can only be disabled by resetting it to the delivery status. This means, all parameter settings made by the user get lost! [▶ Reset parameters to default](#) [□ 346](#)

Details

Usually the write access protection function is implemented by the engineer/OEM, for example to protect the inverter against incorrect parameterization by non-authorized persons. For diagnostic purposes, a read access to all parameters is always possible.

The write access protection allows for the following configurations:

- Full write access
- Write access only to favorites or (when knowing PIN1) to all parameters
- No write access or (when knowing PIN2) full write access
- No write access or (when knowing PIN1) write access only to favorites or (when knowing PIN2) to all parameters

The following table compares the four possible configurations:

PIN1 setting	PIN2 setting	Log-in	Status display after log-in	Active write access protection (via keypad/»EASY Starter«)
0x203D (P730.00)	0x203E (P731.00)	0x203F	0x2040 (P197.00)	
0	0	-	0	No access protection configured.
Access →				
		Diagnostics (read access)	Favorites	All parameters
> 0	0	0 or wrong PIN	2	Write access only possible to favorites.
		Correct PIN1	0	Write access to all parameters possible.
Access →				
		Diagnostics (read access)	Favorites	All parameters PIN1
0	> 0	0 or wrong PIN	1	No write access.
		Correct PIN2	0	Write access to all parameters possible.
Access →				
		Diagnostics (read access)	Favorites	All parameters PIN2
> 0	> 0	0 or wrong PIN	1	No write access.
		Correct PIN1	2	Write access only possible to favorites.
		Correct PIN2	0	Write access to all parameters possible.
Access →				
		Diagnostics (read access)	Favorites	All parameters PIN1 PIN2
If PIN1 and PIN2 are set identically, a write access to all parameters is possible after the PIN has been entered correctly.				

Device functions

Access protection
Write access protection



Notes:

- The access protection is realised by the keypad and engineering tools as "clients" themselves based on the current protection status [0x2040 \(P197.00\)](#).

More details on how to configure the write access protection with the respective client can be found in the following subchapters:

- ▶ [Write access protection in the »EASY Starter«](#) [353](#)
- ▶ [Write access protection in the keypad](#) [356](#)



Parameter

Address	Name / setting range / [default setting]	Information
0x203D (P730.00)	PIN1 access protection (PIN1 protection) -1 ... [0] ... 9999	PIN definition for write access protection. <ul style="list-style-type: none">• 1 ... 9999 = set/change PIN.• 0 = delete PIN (deactivate access protection).• When the PIN has been set successfully, the value -1 is shown; otherwise 0.• Setting/changing the PIN via keypad/»EASY Starter« only possible if no write access protection is active.• Settings/changes via »EASY Starter« become effective immediately; via keypad they only become effective when the parameter group has been exited.
0x203E (P731.00)	PIN2 access protection (PIN2 protection) -1 ... [0] ... 9999	
0x203F	PIN1/PIN2 log-in -32768 ... [0] ... 32767	Parameter for PIN entry for the purpose of deactivating an active access protection temporarily. <ul style="list-style-type: none">• 1 ... 9999 = log-in (deactivate access protection temporarily).• 0 = log-out (reactivate access protection).• After having logged in successfully, the value 0 is shown; otherwise -1.• After 10 invalid entries, the log-in function is inhibited. In order to remove the log-in inhibit, the inverter must be switched off and on again.



13.4.1.1 Write access protection in the »EASY Starter«

If a write access protection is active for the online connected inverter, it is displayed in the status bar of the »EASY Starter«:

Display	Representation of the parameters in the »EASY Starter«
 No write access	All parameters in all dialogs are displayed as read-only parameters.
 Only favorites	Except for the favorites, all parameters in all dialogs are displayed as read-only parameters.

An active write access protection can be removed when the PIN is known.

How to remove an active write access protection temporarily:

1. Click the symbol  in the toolbar.

The "Log in / Log off" dialog box is displayed:

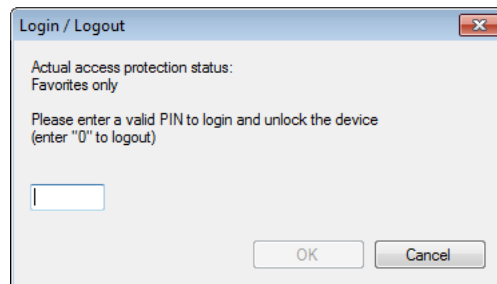

2. Enter the valid PIN and confirm with **OK**.



After 10 invalid entries, the log-in function is inhibited. In order to remove the log-in inhibit, the inverter must be switched off and on again.

The write access protection gets active again:

- Automatically 10 minutes after the last login or after the last active write access. It takes max. 10 minutes to be automatically logged out again after each write access.
- Automatically after the mains voltage is switched on again.
- Manually by entering a "0" in the dialog box "Log in / Log off" (see above).

Device functions

Access protection
Write access protection



Configuring the write access protection with »EASY Starter«

The write access protection is activated by specifying PIN1 and/or PIN2 (depending on the desired configuration of the write access protection).

How to activate the write access protection:

1. Go to the "Settings" tab and navigate to the "Access protection" parameterisation dialog:

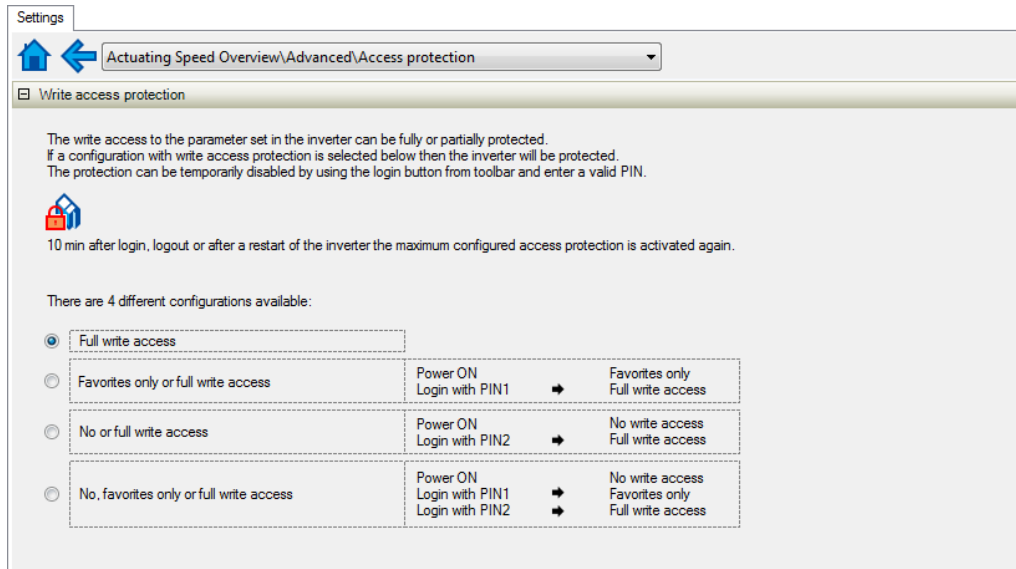

2. Select the desired configuration of the write access protection.

The "PIN definition" dialog box is displayed. The possible entries depend on the selected configuration.

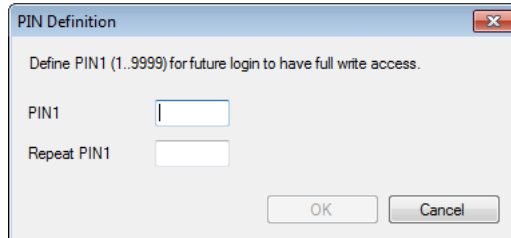



3. Enter the desired PIN(s) and confirm with **OK**.



After successful execution, the write access protection is immediately effective and is displayed in the »EASY Starter« status bar.

4. For a permanent acceptance of the configuration:  Save parameter settings in the device.

How to change already defined PIN(s):

1.  Remove the active write access protection temporarily (see above).
2. Select the "Full write access" configuration in the "Access protection" parameterisation dialog.
3. Select again the desired configuration of the write access protection.
4. Enter new PIN(s) and confirm with **OK**.
5.  Save parameter settings in the device.

How to remove a configured write access protection permanently:

1.  Remove the active write access protection temporarily (see above).
2. Select the "Full write access" configuration in the "Access protection" parameterisation dialog.
3.  Save parameter settings in the device.



Impact of the write access protection on »EASY Starter« functions

The following »EASY Starter« functions are not supported when write access protection is active:

- Parameter set download
- Definition of the "Favorites" parameters.
- Definition of the parameters for the "Parameter change-over" function

The following »EASY Starter« functions are supported irrespective of whether write access protection is active:

- Optical device identification [0x2021:001 \(P230.01\)](#)
- Enable/inhibit inverter
- Resetting parameters to default [0x2022:001 \(P700.01\)](#)
- Save parameter set [0x2022:003 \(P700.03\)](#)
- Load user parameter [0x2022:004 \(P700.04\)](#)
- Load OEM parameter [0x2022:005 \(P700.05\)](#)
- Error reset [0x2631:004 \(P400.04\)](#)

Device functions

Access protection
Write access protection



13.4.1.2 Write access protection in the keypad

If a write access protection is active for the inverter, the keypad automatically displays a log-in when changing to the parameterisation mode. You can either skip the log-in and thus keep the access protection active or remove it temporarily by entering a valid PIN.

Option 1 - skip log-in and keep access protection active

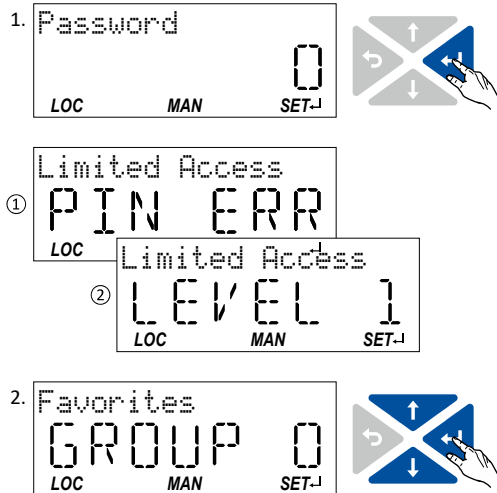

1. Use the **←** key to skip the log-in.

The configured access protection remains active and is briefly displayed:

- ① PIN ERR: No write access
 - ② LEVEL 1: Write access only to favorites
- You are now in the group level.

2. You can now use the navigation keys **↑** and **↓** to select the desired group and with key **←** navigate one level lower to the parameter level.

Note: By using the **↶** key you can navigate one level upwards again anytime.

Option 2 - remove access protection temporarily by entering a valid PIN

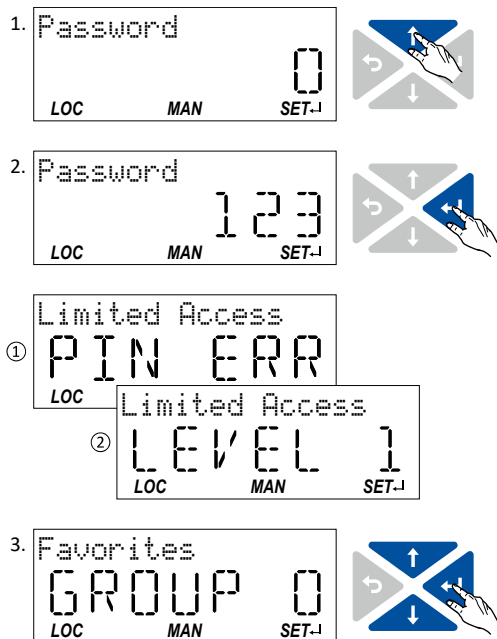

1. Use the **↑** key to enter the defined PIN.

2. Use the **←** key to accept the changed setting.

If the access remains restricted, it is briefly displayed:

- ① PIN ERR: No write access
 - ② LEVEL 1: Write access only to favorites
- You are now in the group level.

3. You can now use the navigation keys **↑** and **↓** to select the desired group and with key **←** navigate one level lower to the parameter level.

Note: By using the **↶** key you can navigate one level upwards again anytime.



After 10 invalid entries, the log-in function is inhibited. In order to remove the log-in inhibit, the inverter must be switched off and on again.

The write access protection gets active again:







- Automatically 10 minutes after the last log-in or the last keypad entry.
- Automatically after the mains voltage is switched on again.



Configuring the write access protection with the keypad

The write access protection is activated by defining PIN1 in P730.00 and/or PIN2 in P731.00 (depending on the desired configuration of the write access protection).

In the following example, the write access protection is configured in such a way that a write access to the favorites only is possible or (when knowing PIN) to all parameters. This configuration only requires the definition of PIN1 (here: "123").

1. VEL:FLEX:AIN1
STOP
REM AUTO SET-1 
2. Favorites
GROUP 0
REM AUTO SET-1 
3. Addit. functions
GROUP 7
REM AUTO SET-1 
4. Device commands
P700.XX
REM AUTO SET-1 
5. Protection PIN1
P73000
REM AUTO SET-1 
6. P730.00
0
REM AUTO SET-1 
7. P730.00
123
REM AUTO SET-1 

Defining PIN1:

1. Use the  key in the operating mode to navigate to the parameterisation mode one level below.

You are now in the group level.

Note: By using the  key you can navigate one level upwards again anytime.

2. Use the  navigation key to select group 7.

3. Use the  key to navigate to one level below.

You are now in the parameter level of the group selected.

4. Use the  navigation key to select the P730.00 parameter.

5. Use the  key to navigate to one level below.

You are now in the editing mode.

6. Use the  navigation key to set PIN1 to the value "123".

7. Use the  key to accept the changed setting.

The editing mode is exited.

Note: The configured access protection only gets effective after the parameter group is quit.

Device functions

Access protection
Write access protection



In the following example, PIN1 is changed from "123" to "456". For this purpose, the defined PIN must first be deleted by the setting "0".

1. VEL:FLEX:AIN1
STOP
REM AUTO SET-J
2. Password
0
REM AUTO SET-J
3. Password
123
REM AUTO SET-J
4. Favorites
GROUP 0
REM AUTO SET-J
5. Addit. functions
GROUP 7
REM AUTO SET-J
6. Device commands
P700.XX
REM AUTO SET-J
7. Protection PIN1
P730.00
REM AUTO SET-J
8. P730.00
-- 1
REM AUTO SET-J
9. P730.00
0
REM AUTO SET-J
10. Protection PIN1
P730.00
REM AUTO SET-J
11. P730.00
0
REM AUTO SET-J
12. P730.00
456
REM AUTO SET-J

Change defined PIN1:

1. Use the key in the operating mode to navigate to the parameterisation mode one level below. Since the access protection is active, the input dialog for the PIN is displayed.
 2. Use the navigation key to set PIN "123" to remove the access protection temporarily.
 3. Use the key to accept the entered PIN. You are now in the group level.
 4. Use the navigation key to select group 7.
 5. Use the key to navigate to one level below. You are now in the parameter level of the group selected.
 6. Use the navigation key to select the P730.00 parameter.
 7. Use the key to navigate to one level below. You are now in the editing mode.
 8. Use the key to set PIN1 to the value "0". This setting first deletes PIN1.
 9. Use the key to accept the changed setting. The editing mode is exited.
 10. Use the key to navigate again one level below to the editing mode.
 11. Use the navigation key to set the previously deleted PIN1 to the new value "456".
 12. Use the key to accept the changed setting. The editing mode is exited.
- Note: The configured access protection only gets effective after the parameter group is quit.



How to remove a configured write access protection permanently:

1. Remove the active write access protection temporarily (see above).
2. Set PIN1 (P730.00) and PIN2 (P731.00) to the value "0" (see instructions for changing the PIN).

Impact of the write access protection to the keypad functions

The following keypad functions are supported irrespective of the active write access protection:

- Optical device identification [0x2021:001 \(P230.01\)](#)
- Resetting parameters to default [0x2022:001 \(P700.01\)](#)
- Load user parameter [0x2022:004 \(P700.04\)](#)
- Load OEM parameter [0x2022:005 \(P700.05\)](#)

13.5 Switching frequency changeover

The output voltage of the inverter is a DC voltage with sine-coded pulse width modulation (PWM). This corresponds by approximation to an AC voltage with variable frequency. The frequency of the PWM pulses is adjustable and is called "switching frequency".

Not all products support all options.

Details

The switching frequency has an impact on the smooth running performance and the noise generation in the motor connected as well as on the power loss in the inverter. The lower the switching frequency, the better the concentricity factor, the smaller the power loss and the higher the audible noise .

Parameter

Address	Name / setting range / [default setting]	Information
0x2939 (P305.00)	Switching frequency (Switching freq.) * Default setting dependent on the model.	Selection of the inverter switching frequency. Abbreviations used: <ul style="list-style-type: none"> • "Variable": Adaptation of the switching frequency as a function of the current. The carrier frequency is reduced depending on the heat sink temperature and the ixt load. • "Fixed": The carrier frequency is fixed, no frequency reduction. • "Drive-optimised": reduces the capacitive currents from the motor to the earth. • "Min. Pv": increases the capacitive currents from the motor to the earth.
	11 4 kHz variable / min. Pv	
	12 8 kHz variable / min. Pv	
	14 12kHz variable / min. Pv	
	16 4 kHz fixed / min. Pv	
	17 8 kHz fixed / min. Pv	
	18 16 kHz fixed / min. Pv	
	19 12 kHz fixed / min. Pv	
0x293A (P116.00)	Actual switching frequency (Actual sw. freq.) • Read only	Display of the currently active switching frequency of the inverter. Example: <ul style="list-style-type: none"> • "16 kHz variable / drive-optimised / 4 kHz min. [22]" is selected as switching frequency in 0x2939 (P305.00). • An increase of the ambient temperature and/or the load have caused a decrease of the switching frequency to 8 kHz. In this case, this parameter indicates the selection "8 kHz power loss-optimised [7]".
	1 2 kHz drive-optimized	
	2 4 kHz drive-optimized	
	3 8 kHz drive-optimized	
	4 16 kHz drive-optimized	
	5 2 kHz power loss-optimized	
	6 4 kHz power loss-optimized	
	7 8 kHz power loss-optimized	
	8 16 kHz power loss-optimized	
	9 12 kHz drive-optimised	
	10 12 kHz power loss-optimised	

Device functions

Device overload monitoring (ixt)



13.6 Device overload monitoring (ixt)

The inverter calculates the i^*t utilisation in order to protect itself against thermal overload. In simple terms: a higher current or an overcurrent that continues for a longer time causes a higher i^*t utilisation.

⚠ DANGER!

Uncontrolled motor movements by pulse inhibit.

When the device overload monitoring function is activated, pulse inhibit is set and the motor has no torque. A load that is connected to motors without a holding brake may therefore cause uncontrolled movements! Without a load, the motor will coast.

► Only operate the inverter under permissible load conditions.

Details

The device overload monitoring function primarily offers protection to the power section. Indirectly, also other components such as filter chokes, circuit-board conductors, and terminals are protected against overheating. Short-time overload currents followed by recovery periods (times of smaller current utilisation) are permissible. The monitoring function during operation checks whether these conditions are met, taking into consideration that higher switching frequencies and lower stator frequencies as well as higher DC voltages cause a greater device utilisation.

- If the device utilisation exceeds the warning threshold set in [0x2D40:002](#) (default setting: 95 %), the inverter outputs a warning.
- If the device utilisation exceeds the permanent error threshold 100 %, the inverter is disabled immediately and any further operation is stopped.
- Device overload monitoring depends on the inverter load characteristic [0x2D43:001](#) ([P306.01](#)).
- The device overload can be obtained from the configuration document.

Parameter

Address	Name / setting range / [default setting]	Information
0x2D40:002	Device utilisation ixt: Power unit warning threshold 0 ... [95] ... 101 %	If the device utilisation exceeds the threshold set, the inverter outputs a warning. <ul style="list-style-type: none">• With the setting 0 % or ≥ 100 %, the warning is deactivated.
0x2D40:004 (P135.04)	Device utilisation ixt: Device actual utilisation (Device utilisat.: ixt utilisation) <ul style="list-style-type: none">• Read only: x %	Display of the current device utilisation.
0x2D40:005 (P135.05)	Device utilisation ixt: Device utilisation (ixt): Error response (Device utilisat.: Error response)	Selection of the response to be executed when the device overload monitoring function is triggered. Associated error code: <ul style="list-style-type: none">• 9090 0x2382 - Fault - Device utilization (ixt) too high
	2 Trouble	► Error types 456
	3 Fault	

13.7 Heatsink temperature monitoring

Parameter

Address	Name / setting range / [default setting]	Information
0x2D84:001 (P117.01)	Heatsink temperature: Heatsink temperature (Heatsink temp.: Heatsink temp.) <ul style="list-style-type: none">• Read only: x.x °C	Display of the current heatsink temperature.
0x2D84:002	Heatsink temperature: Warning threshold 50.0 ... [80.0]* ... 100.0 °C * Default setting dependent on the model.	Warning threshold for temperature monitoring. <ul style="list-style-type: none">• If the heatsink temperature exceeds the threshold set here, the inverter outputs a warning.• The warning is reset with a hysteresis of approx. 5 °C.• If the heatsink temperature increases further and exceeds the non-adjustable error threshold (100 °C), the inverter changes to the "Fault" device status. The inverter is disabled and thus any further operation is stopped.



13.8 Automatic restart after a fault

Configuration of the restart behaviour after a fault.



The settings have no impact on errors and warnings of the inverter.

Parameter

Address	Name / setting range / [default setting]	Information
0x2839:002 (P760.02)	Fault configuration: Restart delay (Fault config.: Restart delay) 0.0 ... [3.0] ... 1000.0 s	If a fault occurs, a restart is possible at the earliest after the time set here has elapsed.
0x2839:003 (P760.03)	Fault configuration: Number of restart attempts (Fault config.: Restart counter) 0 ... [5] ... 255	Number of restart attempts after a fault. <ul style="list-style-type: none">• 255 = unlimited number of restart attempts.
0x2839:004 (P760.04)	Fault configuration: Trouble counter reset time (Fault config.: Tro.count r.time) 0.1 ... [40.0] ... 3600.0 s	Time of trouble-free operation after which the fault counter is decreased by 1.
0x2839:005 (P760.05)	Fault configuration: Trouble counter (Fault config.: Trouble counter) <ul style="list-style-type: none">• Read only	Display of the current fault counter content. <ul style="list-style-type: none">• The counter content is increased by 1 after each restart attempt.

Related topics

▶ [Error handling](#) 455

▶ [Timeout for error response](#) 457



13.9 User-defined error triggering

The "Activate fault 1" and "Activate fault 2" functions serve to set the inverter from the process to the error status.

Details

If, for instance, sensors or switches are provided for process monitoring, which are designed to stop the process (and thus the drive) under certain conditions, these sensors/switches can be connected to free digital inputs of the inverter. The digital inputs used for the sensors/switches then have to be assigned to the functions "Activate fault 1" and "Activate fault 2" as triggers.

Parameter

Address	Name / setting range / [default setting]	Information
0x2631:043 (P400.43)	Function list: Activate fault 1 (Function list: Fault 1) • Further possible settings: ▶ Trigger list 59	Assignment of a trigger for the "Activate fault 1" function. Trigger = TRUE: Trigger user-defined error 1. Trigger = FALSE: no action. Notes: • After the error is triggered, the motor is brought to a standstill with the quick stop ramp. The inverter is then disabled. Associated error code: • 25217 0x6281 - User-defined fault 1
	0 Not connected	No trigger assigned (trigger is constantly FALSE).
0x2631:044 (P400.44)	Function list: Activate fault 2 (Function list: Fault 2) • Further possible settings: ▶ Trigger list 59	Assignment of a trigger for the "Activate fault 2" function. Trigger = TRUE: Trigger user-defined error 2. Trigger = FALSE: no action. Notes: • After the error is triggered, the motor is brought to a standstill with the quick stop ramp. The inverter is then disabled. Associated error code: • 25218 0x6282 - User-defined fault 2
	0 Not connected	No trigger assigned (trigger is constantly FALSE).

Example

An example of the operating mode can be found in the chapter "[Error reset](#)". 458

Related topics

▶ [Error handling](#) 455



13.10 Update device firmware

The device firmware is continuously improved by the manufacturer. New firmware versions contain error corrections, function extensions and simplify the handling.

A new firmware is always compatible with the older version:

- A device with updated firmware and unchanged parameter settings shows the same behaviour as before.
- Parameter settings must only be adapted if new functions are used.

13.10.1 Firmware download with »EASY Starter (firmware loader)«

The »EASY Starter (firmware loader)« is a PC software which serves to update the firmware of the device.

Preconditions

- For the firmware download, we recommend a direct USB connection to the device. For this purpose, the USB module and a USB 2.0 cable (A plug on Micro-B plug) are required. The voltage supply of the control electronics also takes place via the USB connection.
- The control electronics of the inverter must be supplied with voltage via the USB connection.
- Voltage supply and communication must not be interrupted during the firmware download.

Details

Together with the »EASY Starter« engineering tool, the following tools are installed as well:

Tool	Brief description
»EASY Navigator«	Helps you to find the right tool for your application.
»EASY Package Manager«	Enables the automatic download and the installation of files for the engineering tools. <ul style="list-style-type: none">• For this purpose, the »EASY Package Manager« is provided with current files by the manufacturer and enables the user to install them.• The files also include new firmware versions for inverters.
»EASY Starter (firmware loader)«	Enables the update of the firmware for inverters. <ul style="list-style-type: none">• The update can be made by the mechanical engineer or the end user depending on the access protection set for the device.

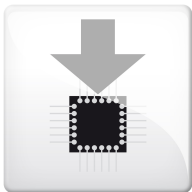

Carry out the firmware download with the »EASY Starter (firmware loader)«:

1. Start »EASY Navigator« (All programs → Lenze → EASY Navigator).
2. In the »EASY Navigator«, change to the "Ensuring productivity" engineering phase.
3. Click the »EASY Starter (firmware loader)« icon (see on the left).
4. Follow the instructions of the »EASY Starter (firmware loader)«.

Notes:

- The firmware download will not take more than 20 seconds. The progress is shown in the »EASY Starter (firmware loader)«.
- After the firmware download, the connection to the device gets lost for some second and is then restored again automatically.
- Device settings are not changed by the firmware download.
- The brand protection does not get lost by the firmware download.
- The firmware can neither be exported from the device nor be deleted from the device.

If the connection is aborted during the firmware download, this may have the following consequences:

- The device starts with the old firmware. The firmware download can be restarted.
- The firmware in the device is damaged. Consultation with the manufacturer is required.

Device functions

Behaviour of the inverter in case of incompatible data in the memory module



13.11 Behaviour of the inverter in case of incompatible data in the memory module

Below you will find a description of the inverter behaviour when the data on the memory module does not match the inverter hardware or firmware.

The following points are described in detail here:

- Automatic loading of the parameter settings when the inverter is switched on
- Manual loading of the user data via device command
- Manual loading of the OEM data via device command
- Manual saving of the parameter settings via device command
- Hardware and firmware updates/downgrades

Automatic loading of the parameter settings when the inverter is switched on

Process when the inverter is switched on:

1. The default setting saved in the inverter firmware is loaded.
2. If a memory module with valid data is available, the data is loaded from the user memory.

Otherwise a corresponding error message is output:

Error message	Info
0x7681: Memory module not present	The default setting saved in the inverter firmware is loaded. The error cannot be reset by the user. Remedy: <ol style="list-style-type: none">1. Switch off inverter.2. Plug the memory module into the inverter.3. Switch the inverter on again. Note: The memory module cannot be replaced during ongoing operation!
0x7682: Memory module: Invalid user data	The user parameter settings in the memory module are invalid. Thus, the user parameter settings get lost. The default setting is loaded automatically. Remedy: <ol style="list-style-type: none">1. Execute user parameter settings again.2. Execute device command "Save user data" 0x2022:003 (P700.03).
0x7684: Data not compl. saved before powerdown	Saving the parameter settings was interrupted by an unexpected disconnection. The user parameter settings were not saved completely. When the inverter is switched on the next time, the backup data is copied to the user memory. Remedy: <ol style="list-style-type: none">1. Check user parameter settings. (The loaded backup is an older version.)2. If required, repeat the changes made last.3. Execute device command "Save user data" 0x2022:003 (P700.03).
0x7689: Memory module: invalid OEM data	The OEM memory contains invalid parameter settings or is empty. The user parameter settings are loaded automatically. Remedy: <ul style="list-style-type: none">• Execute device command "Save OEM data" 0x2022:006 (P700.06).• Thus, the user parameter settings get lost!

Notes:

- If the memory module contains invalid data, the device commands "Load user data" [0x2022:004 \(P700.04\)](#) and "Load OEM data" [0x2022:005 \(P700.05\)](#) are not executed. The status feedback "Action cancelled" takes place.
- If the memory module is empty, the default setting saved in the inverter firmware is loaded. No action is required by the user. The memory module remains empty until the device command "Save user data" [0x2022:003 \(P700.03\)](#) or "Save OEM data" [0x2022:006 \(P700.06\)](#) is executed.
- Irrespective of the data on the memory module, the device command "Load default settings" [0x2022:001 \(P700.01\)](#) is always enabled.

Manual loading of the user data via device command

Device command: "Load user data" [0x2022:004 \(P700.04\)](#)

- If the user memory contains invalid parameter settings, the default setting saved in the inverter firmware is automatically loaded.
- For possible error messages, see the table above.



Manual loading of the OEM data via device command

Device command: "Load OEM data" [0x2022:005 \(P700.05\)](#)

- If the OEM memory contains invalid parameter settings, the user parameter settings are loaded automatically.
- If the OEM memory is empty, the status feedback "Action cancelled" takes place. The current parameter settings remain unchanged.

Manual saving of the parameter settings via device command

Device command: "Save user data" [0x2022:003 \(P700.03\)](#)

- It may happen that the parameter settings cannot be saved because the user memory is full. In this case, the following error message appears:

Error message	Info
0x7680 : Memory module is full	The memory module contains too many parameter settings. The parameter settings were not saved in the memory module. Remedy: Execute device command "Save user data" 0x2022:003 (P700.03) again. This reinitialises the user memory with the current parameter settings. By this means, parameter settings no longer required are deleted automatically.

Device functions

Behaviour of the inverter in case of incompatible data in the memory module



Hardware and firmware upgrades/downgrades

By "taking along" the memory module, all parameter settings of a device can be transferred to another device, for instance, in case of a device replacement. When switched on, the inverter checks whether the parameter settings saved in the memory module match the inverter hardware and firmware. In case of an incompatibility, a corresponding error message is output.

The following table contains details on different scenarios:

Prio	Compatibility check User data ↔ device	Error message	Info
1	Device has a newer firmware Example: Version 2.x → version 3.x	-	The "firmware upgrade" is recognised. <ul style="list-style-type: none"> The user parameter settings are loaded without an action being required by the user. If the parameter settings are saved afterwards, the user memory is reinitialised with the current parameter settings. By this means, parameter settings no longer required are deleted automatically.
	Device has an older firmware Example: Version 4.x → version 3.x	0x7690: EPM firmware version incompatible	The data is loaded into the RAM memory but are incompatible. Remedy:
2	Firmware type is different	0x7691: EPM data: firmware type incompatible	<ol style="list-style-type: none"> Execute device command "Load default settings" 0x2022:001 (P700.01). Execute "Save user data" 0x2022:003 (P700.03) or "Save OEM data" 0x2022:006 (P700.06) device command.
	Power unit is different (and incompatible with saved data)	0x7693: EPM data: PU size incompatible	
	Country code is different Example: EU → USA	0x7691: EPM data: firmware type incompatible	
	Device has less functionality Examples: i550 → i510 Application I/O → Standard I/O		
3	Network option is different Example: CANopen → PROFIBUS	0x7692: EPM data: new firmware type detected	The data is loaded into the RAM memory and is compatible. However, the settings must be accepted by the user: <ol style="list-style-type: none"> Check parameter settings. Reset error. Execute "Save user data" 0x2022:003 (P700.03) or "Save OEM data" 0x2022:006 (P700.06) device command.
4	Device has more functionality Examples: i510 → i550 Standard I/O → application I/O	-	The "hardware upgrade" is recognised. <ul style="list-style-type: none"> The user parameter settings are loaded without an action being required by the user. If the parameter settings are saved afterwards, the user memory is reinitialised with the current parameter settings. By this means, parameter settings no longer required are deleted automatically.
5	Power unit is different (but compatible with saved data) Example: 230 V/0.75 kW → 400 V/5.5 kW	0x7694: EPM data: new PU size detected	The data is loaded into the RAM memory and is compatible. However, the settings must be accepted by the user: <ol style="list-style-type: none"> Check parameter settings. Reset error. Execute "Save user data" 0x2022:003 (P700.03) or "Save OEM data" 0x2022:006 (P700.06) device command.



14 Additional functions

14.1 Brake energy management

When braking electrical motors, the kinetic energy of the drive train is fed back regeneratively to the DC bus. This energy causes a DC-bus voltage boost. If the energy fed back is too high, the inverter reports an error.

Several different strategies can serve to avoid DC-bus overvoltage:

- Stopping the deceleration ramp function generator when the active voltage threshold for the brake operation is exceeded
- Use of the "Inverter motor brake" function
- Combination of the above named options

Details

The voltage threshold for braking operation results on the basis of the rated mains voltage set:

Rated mains voltage	Voltage thresholds for braking operation	
	Braking operation on	Braking operation off
230 V	DC 390 V	DC 380 V
400 V	DC 725 V	DC 710 V
480 V	DC 780 V	DC 765 V

The voltage threshold for braking operation can be reduced by 0 ... 100 V. The reduction required must be set in [0x2541:003 \(P706.03\)](#). However, the reduction must be made to such an extent that the reduced voltage threshold is still above the normal stationary DC-bus voltage. The active voltage threshold for the braking operation is displayed in [0x2541:002 \(P706.02\)](#).

If the DC-bus voltage exceeds the voltage threshold for braking operation, the braking method selected in [0x2541:001 \(P706.01\)](#) is applied.

- Stopping the deceleration ramp function generator enables smoother deceleration with lower torque oscillation.
- The "Inverter motor brake" function allows for quick braking. For process-related reasons, torque oscillations may occur.

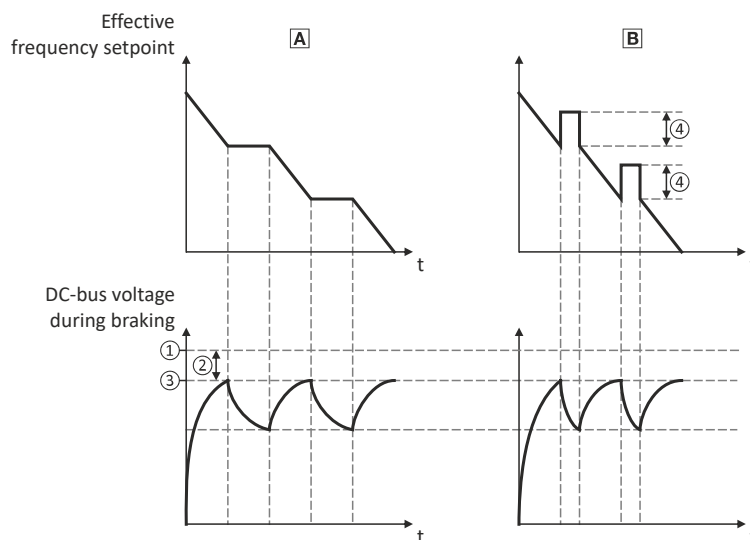

- ① Voltage threshold for braking operation
- ② Reduced threshold [0x2541:003 \(P706.03\)](#)
- ③ Active threshold [0x2541:002 \(P706.02\)](#)
- ④ Additional frequency [0x2541:004 \(P706.04\)](#)

- Ⓐ [Stopping the deceleration ramp function generator](#) [368](#)
- Ⓑ [Inverter motor brake](#) [369](#)

Additional functions

Brake energy management
Stopping the deceleration ramp function generator



Parameter

Address	Name / setting range / [default setting]	Information
0x2541:001 (P706.01)	Brake energy management: Operating mode (Brake management: Operating mode)	Selection of the braking method. <ul style="list-style-type: none">The braking method(s) selected is/are activated if the DC-bus voltage exceeds the voltage threshold for the braking operation shown in 0x2541:002 (P706.02).
	1 Ramp function generator stop (RFGS)	The deceleration ramp function generator is stopped. ▶ Stopping the deceleration ramp function generator 368
	3 Inverter motor brake (IMB) + RFGS	Braking with the "Inverter motor brake" braking method in connection with "Deceleration ramp function generator stop" is executed. ▶ Inverter motor brake 369
0x2541:002 (P706.02)	Brake energy management: Active threshold (Brake management: Active threshold) <ul style="list-style-type: none">Read only: x V	Display of the active voltage threshold for the braking operation. <ul style="list-style-type: none">The voltage threshold shown depends on the mains voltage selected in 0x2540:001 (P208.01) and the voltage value set in 0x2541:003 (P706.03).The voltage threshold must be higher than the stationary DC voltage in the DC bus.
0x2541:003 (P706.03)	Brake energy management: Reduced threshold (Brake management: Red. threshold) 0 ... [0] ... 100 V	The voltage threshold for the braking operation is reduced by the voltage value set here.
0x2541:005 (P706.05)	Brake energy management: Deceleration override time (Brake management: Del. overr. time) 0.0 ... [2.0] ... 60.0 s	Maximum permissible time for the deceleration override by means of the braking method selected in 0x2541:001 (P706.01) . <ul style="list-style-type: none">If the DC-bus voltage does not fall below the voltage threshold for braking operation shown in 0x2541:002 (P706.02) within this time, the motor is decelerated further.The time is only reset if the voltage threshold shown in 0x2541:002 (P706.02) is not reached.

14.1.1 Stopping the deceleration ramp function generator

The deceleration ramp function generator is stopped for a short time if the voltage threshold for braking operation is exceeded.

Details

When this braking method is selected, the maximum permissible time for the deceleration override has to be set in [0x2541:005 \(P706.05\)](#).

- If the DC-bus voltage does not fall below the voltage threshold for braking operation shown in [0x2541:002 \(P706.02\)](#) within this time, the motor is decelerated further.
- The time is only reset if the voltage threshold shown in [0x2541:002 \(P706.02\)](#) is not reached.

Precondition



The "inverter motor brake" braking method only works in operating mode [0x6060 \(P301.00\)](#) = "MS: Velocity mode [-2]".



14.1.2 Inverter motor brake

NOTICE

If it is braked too frequently, there is a risk of the motor being thermally overloaded or the motor overload monitoring does not work properly!

The "Inverter motor brake" braking method must not be used with vertical conveyors (hoists) or with active loads!

Avoid activating the "Inverter motor brake" function over a longer time!

- ▶ The "inverter motor brake" braking method only works in operating mode [0x6060 \(P301.00\)](#) = "MS: Velocity mode [-2]".
- ▶ In applications with a high mass inertia and long braking times (> 2 s), use the "DC braking" function.

With this braking method, which can be selected in [0x2541:001 \(P706.01\)](#), the regenerative energy is converted into heat in the motor as a result of rapid acceleration/deceleration with down-ramping of the ramp function generator.

Conditions



The "inverter motor brake" braking method only works in operating mode [0x6060 \(P301.00\)](#) = "MS: Velocity mode [-2]".

- When this braking method is used, the motor overload monitoring is not adapted. A too frequent use of the inverter motor brake may cause an incorrect operation of the motor overload monitoring. ▶ [Motor overload monitoring \(i²xt\)](#) 224

Details

During the deceleration process, the ramp function generator is stopped. The frequency set in [0x2541:004 \(P706.04\)](#) is added to the frequency setpoint, taking the sign of the current actual frequency into consideration. Furthermore the ramp function generator is stopped in a state of overvoltage. If the DC-bus voltage falls below a defined DC-bus voltage potential, the additional frequency connected is reduced again and the ramp function generator is re-activated. By the alternating acceleration and deceleration resulting from this circuit, the energy is converted thermally in the motor. For process-related reasons, torque oscillations may occur.

Setting instructions

Generally, the smallest value possible required by the application for being able to still traverse the load to be moved in a controlled fashion should be set as additional frequency. Greater mass inertia values require an increase in the rated motor frequency set. Increasing the rated motor frequency, however, causes greater torque oscillations. A possible consequence is the reduced service life of mechanical components. Furthermore an increase in the rated motor frequency also increases the energy converted into heat in the motor. A possible consequence is the reduced service life of the motor.

Parameter

Address	Name / setting range / [default setting]	Information
0x2541:004 (P706.04)	Brake energy management: Additional frequency (Brake management: Add.frequency) 0.0 ... [0.0] ... 10.0 Hz	Frequency deviation which is connected to the deceleration ramp in a pulsative fashion when the "Inverter motor brake" braking method is used.

Additional functions

Parameter change-over



14.2 Parameter change-over

For up to 32 freely selectable parameters, this function provides a change-over between four sets with different parameter values.

DANGER!

Changed parameter settings can become effective immediately depending on the activating method set in [0x4046 \(P755.00\)](#).



The possible consequence is an unexpected response of the motor shaft while the inverter is enabled.

- ▶ If possible, only carry out parameter changes while the inverter is disabled.
- ▶ Certain device commands or settings which might cause a critical state of the drive behaviour can generally only be carried out when the inverter is inhibited.

Details

The parameter list is compiled in the same way as that of the "Favorites" via configuration. »EASY Starter« provides a user-friendly parameterisation dialog for this purpose.

Change-over to another value set can optionally be effected via corresponding device commands and/or special functions/triggers:

- ▶ [Device commands for parameter change-over](#)  373
- ▶ [Functions for parameter change-over](#)  375



Additional functions

Parameter change-over

Example: Selective control of several motors with one inverter

14.2.1 Example: Selective control of several motors with one inverter

14.2.1.1

A typical application for the parameter change-over is an application/machine in which several axes must be triggered successively but a simultaneous operation of several motors is not required. In this case, one and the same inverter can trigger the motors in succession. Advantages of this solution are the reduced amount of components (inverters) and a reduced energy consumption.

Principle:

- The motor to be currently controlled is connected to the inverter via motor contactors. (The contactor system can, for instance, be controlled via the digital outputs of the inverter.)
- At the same time, the motor and control settings suitable for motor are activated in the inverter by means of parameter change-over.

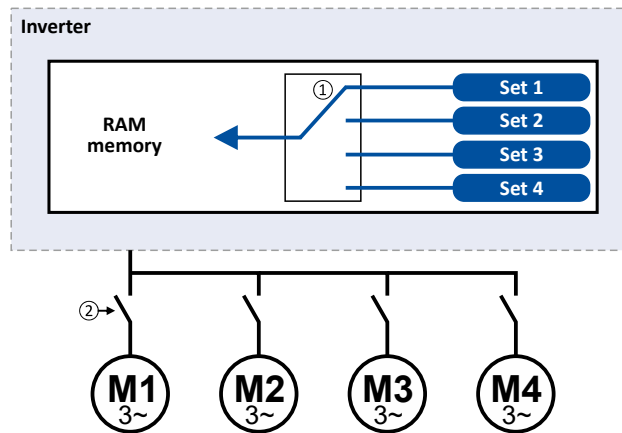

- Motor data change-over (via the "parameter change-over" function)
- Motor change-over (e.g. via motor contactors)

The following table lists all parameters that require different settings for the four motors:

#	Parameter	Name	Setting			
			M1	M2	M3	M4
1	0x2B00 (P302.00)	V/f characteristic shape	Linear [0]	Square-law [1]	Linear [0]	Linear [0]
2	0x2B01:002 (P303.02)	Base frequency	60 Hz	60 Hz	60 Hz	50 Hz
3	0x2D4B:001 (P308.01)	Maximum utilisation [60 s]	150 %	120 %	150 %	150 %
4	0x2B12:001 (P316.01)	Fixed boost	2.5 %	0.0 %	4.0 %	2.0 %
5	0x2C01:004 (P320.04)	Rated speed	1745	3450	1750	1450
6	0x2C01:005 (P320.05)	Rated frequency	60.0 Hz	60.0 Hz	60.0 Hz	50.0 Hz
7	0x2C01:006 (P320.06)	Rated power	0.75 kW	0.75 kW	0.75 kW	1.50 kW
8	0x2C01:007 (P320.07)	Rated voltage	480 V	480 V	480 V	400 V
9	0x6075 (P323.00)	Rated motor current	2,200 A	2,100 A	2,200 A	3,500 A
10	0x6073 (P324.00)	Max. current	200.0 %	150.0 %	200.0 %	200.0 %

Additional functions

Parameter change-over
Parameter set configuration



Settings required for the "parameter change-over" function

The easiest way to make the required settings is via the parameterization dialog in the »EASY Starter«:

1. Click the button to first select the 10 relevant parameters.
2. Set values for motor M1 ... M4 in the corresponding fields:

Zeile	Adresse	Display Code	Name	Einheit	Aktiver Wert	Wert 1	Wert 2	Wert 3	Wert 4
1	0x2B00:000	P302:000	V/f characteristic shape		Linear [0]	Linear [0]	Quadratic [1]	Linear [0]	Linear [0]
2	0x2B01:002	P303:002	V/f shape data: Base frequency	Hz	50	50	50	50	50
3	0x2D4B:001	P308:001	Motor overload monit. (i ²): Maxim...	%	150	150	150	150	150
4	0x2B12:001	P316:001	V/f voltage boost: Fixed boost	%	2.5	2.5	0.0	4.0	2.0
5	0x2C01:004	P320:004	Motor parameters: Rated speed	rpm	1745	1745	3450	1750	1450
6	0x2C01:005	P320:005	Motor parameters: Rated frequency	Hz	60.0	60.0	60.0	60.0	50.0
7	0x2C01:006	P320:006	Motor parameters: Rated power	kW	0.75	0.75	0.75	0.75	1.50
8	0x2C01:007	P320:007	Motor parameters: Rated voltage	V	480	480	480	480	400
9	0x6075:000	P323:000	Motor rated current	A	2.200	2.200	2.100	2.200	3.500
10	0x6073:000	P324:000	Max current	%	200.0	200.0	150.0	200.0	200.0

In case of a direct setting in the parameters of the "parameter change-over" function:

- The addresses must be set in the following: 0xiiii:ss00 (iiii = hexadecimal index, ss = hexadecimal subindex) The keypad can be used to select the desired parameter from a list.
- The values for the motors must be set as integer values. The integer value results from the multiplication of the actual setting value by the factor of the respective parameter. In the table of attributes, the factor for each parameter must be given.

The following table shows the required settings:

#	Address 0x4041:x (PAR 750/x)		Name	Value 1 0x4042:x (PAR 752/x)	Value 2 0x4043:x (PAR 753/x)	Value 3 0x4044:x (PAR 754/x)	Value 4 0x4045:x (PAR 755/x)
	hex	decimal					
1	0x2B000000	721420288	V/f characteristic shape	0	1	0	0
2	0x2B010200	721486336	Base frequency	60	60	60	50
3	0x2D4B0100	759890176	Maximum utilisation [60 s]	150	120	150	150
4	0x2B120100	722600192	Fixed boost	25	0	40	20
5	0x2C010400	738264064	Rated speed	1745	3450	1750	1450
6	0x2C010500	738264320	Rated frequency	600	600	600	500
7	0x2C010600	738264576	Rated power	75	75	75	150
8	0x2C010700	738264832	Rated voltage	480	480	480	400
9	0x60750000	1618280448	Rated motor current	2200	2100	2200	3500
10	0x60730000	1618149376	Max. current	2000	1500	2000	2000

14.2.2 Parameter set configuration

Parameter

Address	Name / setting range / [default setting]	Information
0x4041:001 ... 0x4041:032 (P750.01 ... 32)	Parameter change-over: Parameter 1 ... Parameter 32 (Param.set setup: Parameter 1 ... Parameter 32) 0x00000000 ... [0x00000000] ... 0xFFFFF00	Definition of the parameter list for the "Parameter change-over" function. <ul style="list-style-type: none"> • Format: 0xiiii:ss00 (iiii = hexadecimal index, ss = hexadecimal subindex) • The lowest byte is always 0x00.



Additional functions

Parameter change-over Device commands for parameter change-over

Address	Name / setting range / [default setting]	Information																								
0x4042:001 ... 0x4042:032 (P751.01 ... 32)	Parameter value set 1: Value of parameter 1 ... Value of parameter 32 (Par. value set 1: Set 1 - Value 1 ... Set 1 - Value 32) -2147483648 ... [0] ... 2147483647	Value set 1 for the parameter list defined in 0x4041:001 ... 0x4041:032 (P750.01 ... 32).																								
0x4043:001 ... 0x4043:032 (P752.01 ... 32)	Parameter value set 2: Value of parameter 1 ... Value of parameter 32 (Par. value set 2: Set 2 - Value 1 ... Set 2 - Value 32) -2147483648 ... [0] ... 2147483647	Value set 2 for the parameter list defined in 0x4041:001 ... 0x4041:032 (P750.01 ... 32).																								
0x4044:001 ... 0x4044:032 (P753.01 ... 32)	Parameter value set 3: Value of parameter 1 ... Value of parameter 32 (Par. value set 3: Set 3 - Value 1 ... Set 3 - Value 32) -2147483648 ... [0] ... 2147483647	Value set 3 for the parameter list defined in 0x4041:001 ... 0x4041:032 (P750.01 ... 32).																								
0x4045:001 ... 0x4045:032 (P754.01 ... 32)	Parameter value set 4: Value of parameter 1 ... Value of parameter 32 (Par. value set 4: Set 4 - Value 1 ... Set 4 - Value 32) -2147483648 ... [0] ... 2147483647	Value set 4 for the parameter list defined in 0x4041:001 ... 0x4041:032 (P750.01 ... 32).																								
0x4047:001 (P756.01)	Parameter change-over error message: Status (PSet error msg.: Status) • Read only <table border="1" style="width: 100%; border-collapse: collapse;"> <tr><td style="width: 10%; text-align: center;">0</td><td>No fault</td></tr> <tr><td style="text-align: center;">33803</td><td>Invalid data type</td></tr> <tr><td style="text-align: center;">33804</td><td>Range violation</td></tr> <tr><td style="text-align: center;">33806</td><td>Invalid index</td></tr> <tr><td style="text-align: center;">33813</td><td>No element selected</td></tr> <tr><td style="text-align: center;">33815</td><td>Writing impermissible</td></tr> <tr><td style="text-align: center;">33816</td><td>Device not inhibited</td></tr> <tr><td style="text-align: center;">33829</td><td>Invalid subindex</td></tr> <tr><td style="text-align: center;">33837</td><td>Access impermissible</td></tr> <tr><td style="text-align: center;">33860</td><td>Parameter not mappable</td></tr> <tr><td style="text-align: center;">33865</td><td>No subindexes</td></tr> <tr><td style="text-align: center;">33876</td><td>Parameter not changeable</td></tr> </table>	0	No fault	33803	Invalid data type	33804	Range violation	33806	Invalid index	33813	No element selected	33815	Writing impermissible	33816	Device not inhibited	33829	Invalid subindex	33837	Access impermissible	33860	Parameter not mappable	33865	No subindexes	33876	Parameter not changeable	Error message for the "parameter change-over" function. <ul style="list-style-type: none"> In the event of an error, an error status is shown here, and in 0x4047:002 (P756.02) the number of the list entry in which the error has occurred is displayed (in connection with the value set selected). If several errors occur at the same time, only the first incorrect list entry will be displayed. Hence, after elimination of the displayed error and repeated activation, more errors may be displayed. The parameter list will always be processed from beginning to end, even if errors occur in the meantime.
0	No fault																									
33803	Invalid data type																									
33804	Range violation																									
33806	Invalid index																									
33813	No element selected																									
33815	Writing impermissible																									
33816	Device not inhibited																									
33829	Invalid subindex																									
33837	Access impermissible																									
33860	Parameter not mappable																									
33865	No subindexes																									
33876	Parameter not changeable																									
0x4047:002 (P756.02)	Parameter change-over error message: List entry (PSet error msg.: List entry) • Read only	Error message for the "Parameter set changeover" function. <ul style="list-style-type: none"> In the event of an error, the number of the list entry for which the error displayed in 0x4047:001 (P756.01) has occurred is shown here. 																								

14.2.3 Device commands for parameter change-over

The parameter set can be selected with the device commands "Load parameter set 1" ... "Load parameter set 4".

Details

The change-over via the device commands depends on the activation method set in 0x4046 (P755.00):

- Activation method = 1 or 3: Change-over takes place immediately.
- Activation method = 0 or 2: The respective device command is only executed if the inverter is disabled.

Parameter

Address	Name / setting range / [default setting]	Information
0x2022:007 (P700.07)	Device commands: Load parameter set 1 (Device commands: Load par. set 1)	1 = load value set 1 of the "Parameter change-over" function. <ul style="list-style-type: none"> The parameters specified in 0x4041/1...32 are set to the values set in 0x4042/1...32. When the device command has been executed successfully, the value 0 is shown.
	0 Off / ready	Only status feedback
	1 On / start	Execute device command
	2 In progress	Only status feedback
	3 Action cancelled	
	4 No access	
	5 No access (Device disabled)	

Additional functions

Parameter change-over

Device commands for parameter change-over



Address	Name / setting range / [default setting]	Information
0x2022:008 (P700.08)	Device commands: Load parameter set 2 (Device commands: Load par. set 2)	1 = load value set 2 of the "Parameter change-over" function. <ul style="list-style-type: none"> The parameters specified in 0x4041/1...32 are set to the values set in 0x4043/1...32. When the device command has been executed successfully, the value 0 is shown.
	0 Off / ready	Only status feedback
	1 On / start	Execute device command
	2 In progress	Only status feedback
	3 Action cancelled	
	4 No access	
5 No access (Device disabled)		
0x2022:009 (P700.09)	Device commands: Load parameter set 3 (Device commands: Load par. set 3)	1 = load value set 3 of the "Parameter change-over" function. <ul style="list-style-type: none"> The parameters specified in 0x4041/1...32 are set to the values set in 0x4044/1...32. When the device command has been executed successfully, the value 0 is shown.
	0 Off / ready	Only status feedback
	1 On / start	Execute device command
	2 In progress	Only status feedback
	3 Action cancelled	
	4 No access	
5 No access (Device disabled)		
0x2022:010 (P700.10)	Device commands: Load parameter set 4 (Device commands: Load par. set 4)	1 = load value set 4 of the "Parameter change-over" function. <ul style="list-style-type: none"> The parameters specified in 0x4041/1...32 are set to the values set in 0x4045/1...32. When the device command has been executed successfully, the value 0 is shown.
	0 Off / ready	Only status feedback
	1 On / start	Execute device command
	2 In progress	Only status feedback
	3 Action cancelled	
	4 No access	
5 No access (Device disabled)		
0x2022:011 (P700.11)	Device commands: Save parameter set 1 (Device commands: Save par. set 1)	1 = save value set 1 of the "Parameter change-over" function. <ul style="list-style-type: none"> When the device command has been executed successfully, the value 0 is shown.
	0 Off / ready	Only status feedback
	1 On / start	Execute device command
	2 In progress	Only status feedback
	3 Action cancelled	
	4 No access	
5 No access (Device disabled)		
0x2022:012 (P700.12)	Device commands: Save parameter set 2 (Device commands: Save par. set 2)	1 = save value set 2 of the "Parameter change-over" function. <ul style="list-style-type: none"> When the device command has been executed successfully, the value 0 is shown.
	0 Off / ready	Only status feedback
	1 On / start	Execute device command
	2 In progress	Only status feedback
	3 Action cancelled	
	4 No access	
5 No access (Device disabled)		



Additional functions

Parameter change-over Functions for parameter change-over

Address	Name / setting range / [default setting]	Information
0x2022:013 (P700.13)	Device commands: Save parameter set 3 (Device commands: Save par. set 3)	1 = save value set 3 of the "Parameter change-over" function. • When the device command has been executed successfully, the value 0 is shown.
	0 Off / ready	Only status feedback
	1 On / start	Execute device command
	2 In progress	Only status feedback
	3 Action cancelled	
	4 No access	
	5 No access (Device disabled)	
0x2022:014 (P700.14)	Device commands: Save parameter set 4 (Device commands: Save par. set 4)	1 = save value set 3 of the "Parameter change-over" function. • When the device command has been executed successfully, the value 0 is shown.
	0 Off / ready	Only status feedback
	1 On / start	Execute device command
	2 In progress	Only status feedback
	3 Action cancelled	
	4 No access	
	5 No access (Device disabled)	

14.2.4 Functions for parameter change-over

The parameter set can be selected with the functions "Select parameter set (bit 0)" and "Select parameter set (bit 1)".

Details

A value set is selected in a binary-coded fashion via the triggers assigned to the two Select parameter set (bit 0)" and "Select parameter set (bit 1)" functions in compliance with the following truth table:

Select parameter set (bit 1) 0x2631:042 (P400.42)	Select parameter set (bit 0) 0x2631:041 (P400.41)	Selection
FALSE	FALSE	Value set 1
FALSE	TRUE	Value set 2
TRUE	FALSE	Value set 3
TRUE	TRUE	Value set 4

Change-over is effected depending on the activation method selected in 0x4046 (P755.00) when a state change of the selection inputs takes place or via the trigger assigned to the "Load parameter set" function.

Parameter

Address	Name / setting range / [default setting]	Information
0x2631:040 (P400.40)	Function list: Load parameter set (Function list: Load param.set) • Setting can only be changed if the inverter is disabled. • Further possible settings: ▶ Trigger list 59	Assignment of a trigger for the "Load parameter set" function. Trigger = FALSE-TRUE edge: parameter change-over to the value set selected via "Select parameter set (bit 0)" and "Select parameter set (bit 1)". Trigger = FALSE: no action. Notes: • The activation method for the "Parameter change-over" function can be selected in 0x4046 (P755.00).
	0 Not connected	No trigger assigned (trigger is constantly FALSE).
0x2631:041 (P400.41)	Function list: Select parameter set (bit 0) (Function list: Sel. paramset b0) • Setting can only be changed if the inverter is disabled. • Further possible settings: ▶ Trigger list 59	Assignment of a trigger for the "Select parameter set (bit 0)" function. Selection bit with the valency 2 ⁰ for "Parameter change-over" function. Trigger = FALSE: selection bit = "0". Trigger = TRUE: selection bit = "1".
	0 Not connected	No trigger assigned (trigger is constantly FALSE).

Additional functions

Parameter change-over

Functions for parameter change-over



Address	Name / setting range / [default setting]	Information
0x2631:042 (P400.42)	Function list: Select parameter set (bit 1) (Function list: Sel. paramset b1) <ul style="list-style-type: none"> Setting can only be changed if the inverter is disabled. Further possible settings: ▶ Trigger list □ 59 	Assignment of a trigger for the "Select parameter set (bit 1)" function. Selection bit with the valency 2 ¹ for "Parameter change-over" function. Trigger = FALSE: selection bit = "0". Trigger = TRUE: selection bit = "1".
	0 Not connected	No trigger assigned (trigger is constantly FALSE).
0x4046 (P755.00)	Activation of parameter set (PSet activation)	Selection of the activation method for the parameter change-over. <ul style="list-style-type: none"> If the selection is changed from "Via command... [0]/[1]" to "If the selection is changed...[2]/[3]" after switch-on, the parameter set selected via the functions "Select parameter set (bit 0)" and "Select parameter set (bit 1)" is activated immediately. In case of selection [2], however, this only takes place if the inverter is disabled, the motor is stopped or an error is active.
	0 Via command (disable required)	The parameter set selected via the functions "Select parameter set (bit 0)" and "Select parameter set (bit 1)" is activated if the trigger assigned to the "Load parameter set" function in 0x2631:040 (P400.40) provides a FALSE-TRUE edge AND the inverter is inhibited, the motor is stopped or an error is active. ▶ Example: Activation via command (only when disabled) □ 377
	1 Via command (immediately)	The parameter set selected via the functions "Select parameter set (bit 0)" and "Select parameter set (bit 1)" is immediately activated if the trigger assigned to the "Load parameter set" function in 0x2631:040 (P400.40) provides a FALSE-TRUE edge. ▶ Example: Activation via command (immediately) □ 378
	2 If the selection is changed (disable required)	The parameter set selected via the functions "Select parameter set (bit 0)" and "Select parameter set (bit 1)" is activated if the state of these selection bits changes AND the inverter is inhibited, the motor is stopped or an error is active. ▶ Example: Activation if the selection is changed (only if the inverter is disabled) □ 379
	3 If the selection is changed (immediately)	The parameter set selected via the functions "Select parameter set (bit 0)" and "Select parameter set (bit 1)" is activated immediately if the state of these selection bits is changed. ▶ Example: Activation if the selection is changed (immediately) □ 380



14.2.4.1 Example: Activation via command (only when disabled)

Activation method 0x4046 (P755.00) = "Via command (disable required) [0]":

- Switches S3 and S4 serve to select the parameter set (see the following table).
- Switch S2 activates the change-over. Since the change-over is activated with a rising edge, a button (normally-open contact) can be used instead of a switch.
- Change-over is only possible if the motor is not started (switch S1 open).

Connection plan	Function															
	Switch S1 Run															
	Switch S2 Load parameter set															
	Switches S3 ... S4 Parameter set selection:															
	<table border="1"> <thead> <tr> <th>S3</th> <th>S4</th> <th></th> </tr> </thead> <tbody> <tr> <td>Off</td> <td>Off</td> <td>Parameter set 1</td> </tr> <tr> <td>On</td> <td>Off</td> <td>Parameter set 2</td> </tr> <tr> <td>Off</td> <td>On</td> <td>Parameter set 3</td> </tr> <tr> <td>On</td> <td>On</td> <td>Parameter set 4</td> </tr> </tbody> </table>	S3	S4		Off	Off	Parameter set 1	On	Off	Parameter set 2	Off	On	Parameter set 3	On	On	Parameter set 4
	S3	S4														
Off	Off	Parameter set 1														
On	Off	Parameter set 2														
Off	On	Parameter set 3														
On	On	Parameter set 4														

Parameter	Designation	Setting for this example
0x2631:001 (P400.01)	Enable inverter	Constant TRUE [1]
0x2631:002 (P400.02)	Run	Digital input 1 [11]
0x2631:004 (P400.04)	Reset fault	Not connected [0]
0x2631:013 (P400.13)	Reverse rotational direction	Not connected [0]
0x2631:018 (P400.18)	Activate preset (bit 0)	Not connected [0]
0x2631:040 (P400.40)	Load parameter set	Digital input 2 [12]
0x2631:041 (P400.41)	Select parameter set (bit 0)	Digital input 3 [13]
0x2631:042 (P400.42)	Select parameter set (bit 1)	Digital input 4 [14]
0x2824 (P200.00)	Control selection	Flexible I/O configuration [0]
0x4046 (P755.00)	Activation of parameter set	Via command (disable required) [0]

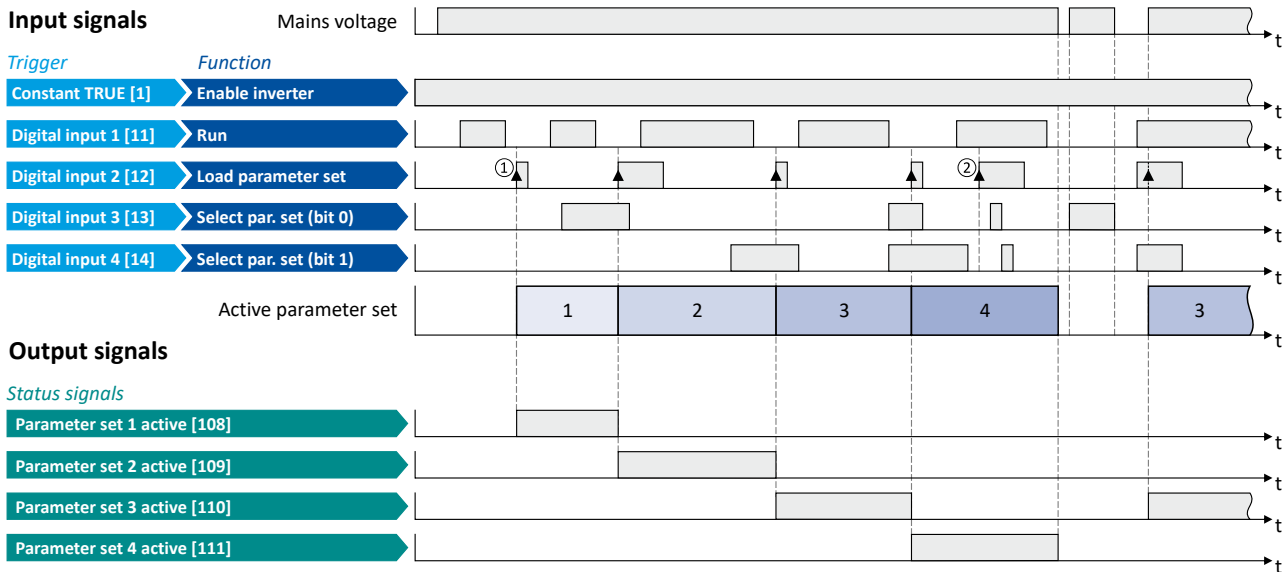

The status signals can be assigned to digital outputs. ▶ [Configure digital outputs](#) 247

- ① The change-over is activated with the "Load parameter set" function (FALSE/TRUE edge).
- ② If the inverter is enabled and the motor is started, a change-over is not possible.

Additional functions

Parameter change-over
Functions for parameter change-over



14.2.4.2 Example: Activation via command (immediately)

Activation method 0x4046 (P755.00) = "Via command (immediately) [1]":

- Switches S3 and S4 serve to select the parameter set (see the following table).
- Switch S2 activates the change-over. Since the change-over is activated with a rising edge, a button (normally-open contact) can be used instead of a switch.
- Change-over takes place immediately, even if the motor is started (switch S1 closed).

Connection plan	Function															
	Switch S1 Run															
	Switch S2 Load parameter set															
	Switches S3 ... S4 Parameter set selection:															
	<table border="1"> <thead> <tr> <th>S3</th> <th>S4</th> <th></th> </tr> </thead> <tbody> <tr> <td>Off</td> <td>Off</td> <td>Parameter set 1</td> </tr> <tr> <td>On</td> <td>Off</td> <td>Parameter set 2</td> </tr> <tr> <td>Off</td> <td>On</td> <td>Parameter set 3</td> </tr> <tr> <td>On</td> <td>On</td> <td>Parameter set 4</td> </tr> </tbody> </table>	S3	S4		Off	Off	Parameter set 1	On	Off	Parameter set 2	Off	On	Parameter set 3	On	On	Parameter set 4
	S3	S4														
Off	Off	Parameter set 1														
On	Off	Parameter set 2														
Off	On	Parameter set 3														
On	On	Parameter set 4														

Parameter	Designation	Setting for this example
0x2631:001 (P400.01)	Enable inverter	Constant TRUE [1]
0x2631:002 (P400.02)	Run	Digital input 1 [11]
0x2631:004 (P400.04)	Reset fault	Not connected [0]
0x2631:018 (P400.18)	Activate preset (bit 0)	Not connected [0]
0x2631:040 (P400.40)	Load parameter set	Digital input 2 [12]
0x2631:041 (P400.41)	Select parameter set (bit 0)	Digital input 3 [13]
0x2631:042 (P400.42)	Select parameter set (bit 1)	Digital input 4 [14]
0x2824 (P200.00)	Control selection	Flexible I/O configuration [0]
0x4046 (P755.00)	Activation of parameter set	Via command (immediately) [1]

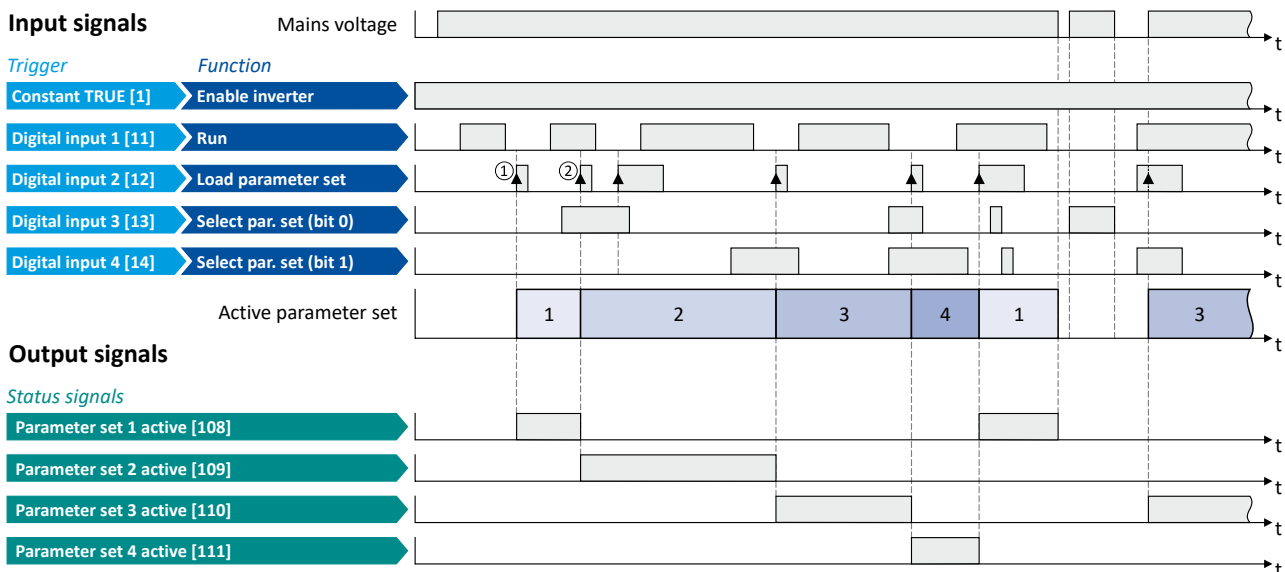

The status signals can be assigned to digital outputs. ▶ [Configure digital outputs](#) □ 247

- ① The change-over is activated with the "Load parameter set" function (FALSE/TRUE edge).
- ② Change-over is also possible if the inverter is enabled and the motor is started.



14.2.4.3 Example: Activation if the selection is changed (only if the inverter is disabled)

Activation method 0x4046 (P755.00) = "If the selection is changed (disable required) [2]":

- Switches S3 and S4 serve to select the parameter set (see the following table). At the same time, the change-over is activated by a status change of the selection inputs.
- Change-over is only possible if the motor is not started (switch S1 open).
- Switch S2 ("Load parameter set") is ignored in this configuration.

Connection plan	Function			
	Switch S1	Run		
	Switch S2	Load parameter set (is ignored in this configuration)		
	Switches S3 ... S4			Parameter set selection and activation at the same time:
	S3	S4		
	Off	Off	Parameter set 1	
On	Off	Parameter set 2		
Off	On	Parameter set 3		
On	On	Parameter set 4		

Parameter	Designation	Setting for this example
0x2631:001 (P400.01)	Enable inverter	Constant TRUE [1]
0x2631:002 (P400.02)	Run	Digital input 1 [11]
0x2631:004 (P400.04)	Reset fault	Not connected [0]
0x2631:013 (P400.13)	Reverse rotational direction	Not connected [0]
0x2631:018 (P400.18)	Activate preset (bit 0)	Not connected [0]
0x2631:040 (P400.40)	Load parameter set	Digital input 2 [12]
0x2631:041 (P400.41)	Select parameter set (bit 0)	Digital input 3 [13]
0x2631:042 (P400.42)	Select parameter set (bit 1)	Digital input 4 [14]
0x2824 (P200.00)	Control selection	Flexible I/O configuration [0]
0x4046 (P755.00)	Activation of parameter set	If the selection is changed (disable required) [2]

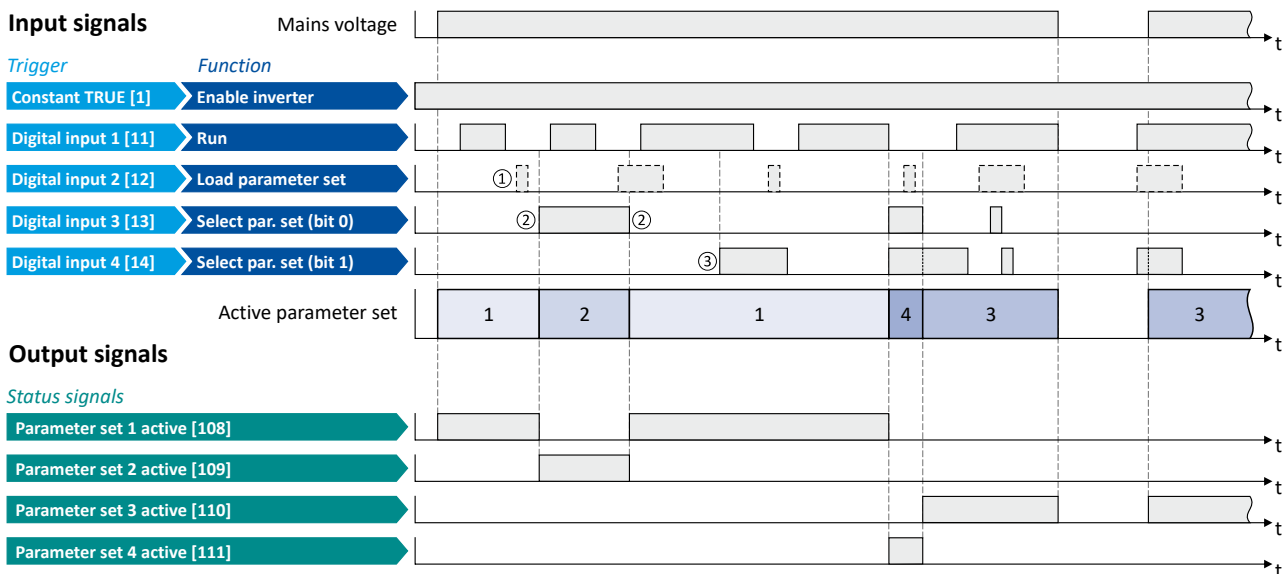

The status signals can be assigned to digital outputs. ▶ [Configure digital outputs](#) □ 247

- ① The "Load parameter set" function is ignored in this configuration.
- ② Change-over takes place by a status change of the selection inputs.
- ③ If the inverter is enabled and the motor is started, a change-over is not possible.

Additional functions

Parameter change-over
Functions for parameter change-over



14.2.4.4 Example: Activation if the selection is changed (immediately)

Activation method 0x4046 (P755.00) = "If the selection is changed (immediately) [3]":

- Switches S3 and S4 serve to select the parameter set (see the following table). At the same time, the change-over is activated by a status change of the selection inputs.
- Change-over takes place immediately, even if the motor is started (switch S1 closed).
- Switch S2 ("Load parameter set") is ignored in this configuration.

Connection plan	Function															
	Switch S1 Run															
	Switch S2 Load parameter set (is ignored in this configuration)															
	Switches S3 ... S4 Parameter set selection and activation at the same time:															
	<table border="1"> <thead> <tr> <th>S3</th> <th>S4</th> <th></th> </tr> </thead> <tbody> <tr> <td>Off</td> <td>Off</td> <td>Parameter set 1</td> </tr> <tr> <td>On</td> <td>Off</td> <td>Parameter set 2</td> </tr> <tr> <td>Off</td> <td>On</td> <td>Parameter set 3</td> </tr> <tr> <td>On</td> <td>On</td> <td>Parameter set 4</td> </tr> </tbody> </table>	S3	S4		Off	Off	Parameter set 1	On	Off	Parameter set 2	Off	On	Parameter set 3	On	On	Parameter set 4
	S3	S4														
Off	Off	Parameter set 1														
On	Off	Parameter set 2														
Off	On	Parameter set 3														
On	On	Parameter set 4														

Parameter	Designation	Setting for this example
0x2631:001 (P400.01)	Enable inverter	Constant TRUE [1]
0x2631:002 (P400.02)	Run	Digital input 1 [11]
0x2631:004 (P400.04)	Reset fault	Not connected [0]
0x2631:013 (P400.13)	Reverse rotational direction	Not connected [0]
0x2631:018 (P400.18)	Activate preset (bit 0)	Not connected [0]
0x2631:040 (P400.40)	Load parameter set	Digital input 2 [12]
0x2631:041 (P400.41)	Select parameter set (bit 0)	Digital input 3 [13]
0x2631:042 (P400.42)	Select parameter set (bit 1)	Digital input 4 [14]
0x2824 (P200.00)	Control selection	Flexible I/O configuration [0]
0x4046 (P755.00)	Activation of parameter set	If the selection is changed (immediately) [3]

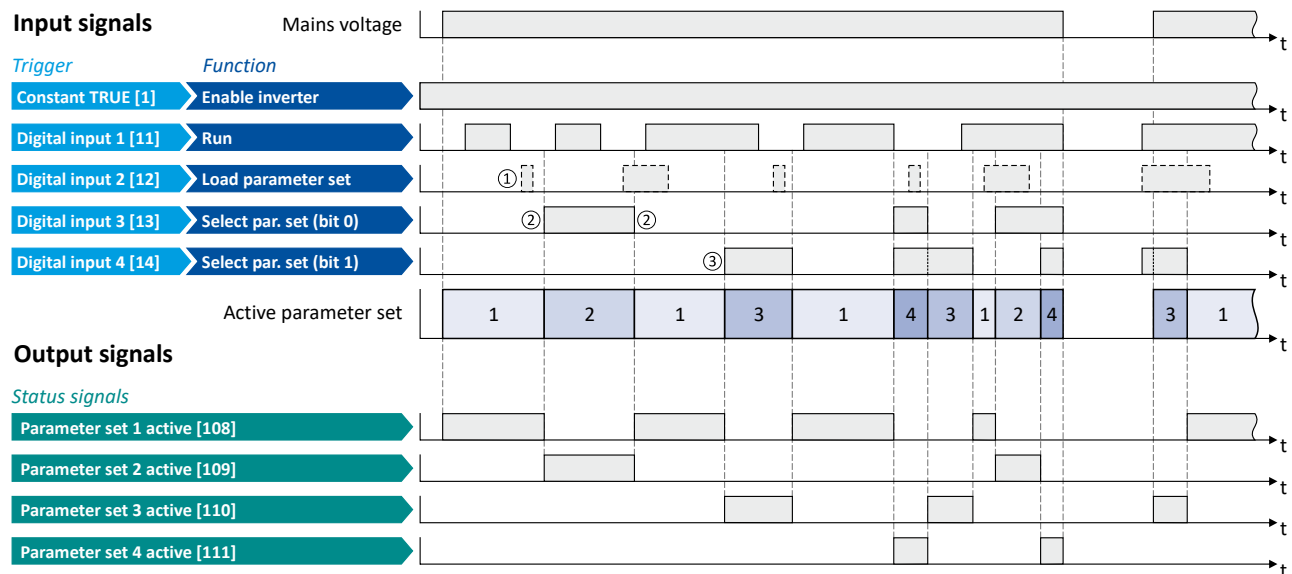

The status signals can be assigned to digital outputs. ▶ [Configure digital outputs](#) □ 247

- ① The "Load parameter set" function is ignored in this configuration.
- ② Change-over takes place by a status change of the selection inputs.
- ③ Change-over is also possible if the inverter is enabled and the motor is started.

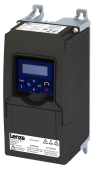

14.3 Trigger action if a frequency threshold is exceeded

As a function of the current output frequency, the adjustable frequency threshold serves to trigger a certain function or set a digital output.

Parameter

Address	Name / setting range / [default setting]	Information
0x4005 (P412.00)	Frequency threshold (Freq. threshold) 0.0 ... [0.0] ... 599.0 Hz	Threshold for the "Frequency threshold exceeded [70]" trigger. <ul style="list-style-type: none"> The "Frequency threshold exceeded [70]" trigger is TRUE if the current output frequency is higher than the set threshold. The trigger can be assigned to a function or to a digital output.

Example for operating mode

In the following example, the digital output 1 is set to TRUE if the output frequency is higher than 20 Hz.

- The analog input 1 is set as standard setpoint source.
- Switch S1 starts the motor in forward direction of rotation. De-Asserting switch S1 stops the motor again.

Connection plan	Function	
	Potentiometer R1	Frequency setpoint selection
	Switch S1	Run

Parameter	Designation	Setting for this example
0x2631:001 (P400.01)	Enable inverter	Constant TRUE [1]
0x2631:002 (P400.02)	Run	Digital input 1 [11]
0x2634:002 (P420.02)	Digital outputs function: Digital output 1	Frequency threshold exceeded [70]
0x2824 (P200.00)	Control selection	Flexible I/O configuration [0]
0x2860:001 (P201.01)	Frequency control: Default setpoint source	Analog input 1 [2]
0x4005 (P412.00)	Frequency threshold	20 Hz

Additional functions

Trigger action if a frequency threshold is exceeded



Input signals



Output signals

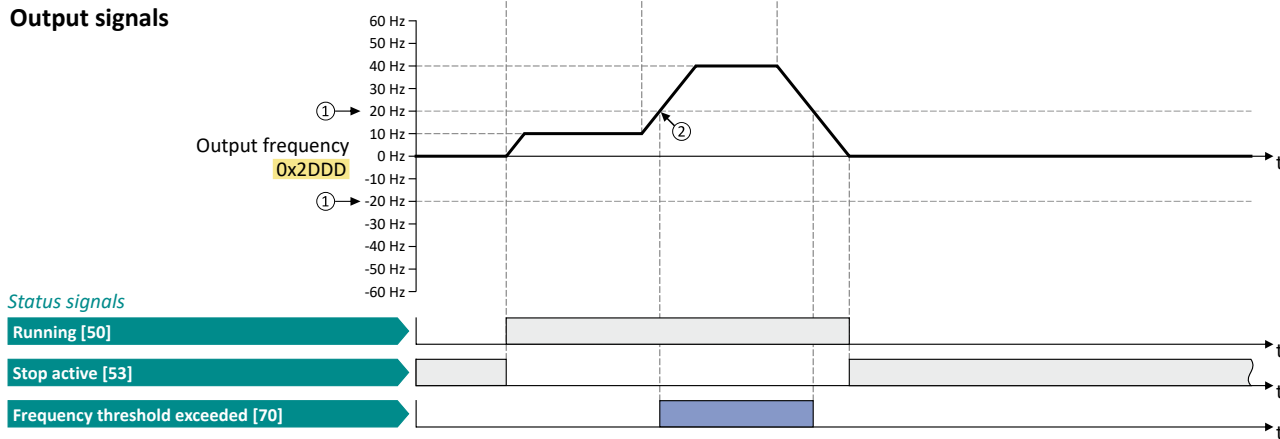

The status signals can be assigned to digital outputs. [▶ Configure digital outputs □ 247](#)

- ① Frequency threshold 0x4005 (P412.00)
- ② Frequency threshold exceeded: Via trigger "Frequency threshold exceeded [70]", the digital output 1 is set to TRUE.



14.4 Position counter

This function counts the number of motor revolutions. The current counter content (actual position) can be output as process data value via network to implement a simple position control in a higher-level Controller.

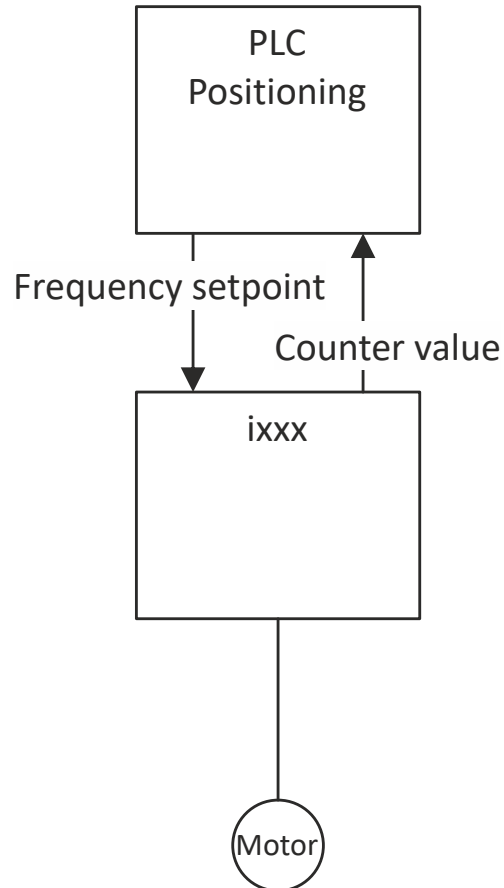

Preconditions

- The number of motor revolutions is reconstructed from the motor model. For this purpose, the motor control type "Sensorless control (SL PSM) [3]" must be selected and set in 0x2C00 (P300.00). ▶ [Sensorless control for synchronous motor \(SL-PSM\)](#) 162
- The position control must be implemented in the Controller.

Additional functions

Position counter



Details

The signal source for the position counter is selected in [0x2C49:001 \(P711.01\)](#). The position counter can count forwards and backwards. The current counter content (actual position) is displayed in [0x2C49:003 \(P711.03\)](#). After the maximum or minimum value has been reached, an overflow takes place.

Reset position counter:

- The position counter is reset when the supply voltage is switched on.
- The position counter can be reset manually via the "Position counter reset" [0x2631:054 \(P400.54\)](#) function or the NetWordIN1 [0x4008:001 \(P590.01\)](#) data word. For a reset via NetWordIN1, the "Position counter reset [54]" function must be assigned to a bit of the data word. Depending on the selection in [0x2C49:002 \(P711.02\)](#), the reset can be made either edge-controlled or status-controlled.

Parameter

Address	Name / setting range / [default setting]	Information
0x2631:054 (P400.54)	Function list: Position counter reset (Function list: PosCounter reset) • From version 03.00 • Further possible settings: ▶ Trigger list 59	Assignment of a trigger for the "Position counter reset" function. Trigger = FALSE-TRUE edge: Reset position counter manually. Trigger = FALSE: no action. Notes: • In 0x2C49:002 (P711.02) it can be selected whether the reset is to be effected edge-controlled (default setting) or status-controlled.
	0 Not connected	No trigger assigned (trigger is constantly FALSE).
0x2C49:001 (P711.01)	Position counter: Signal source (Position counter: Signal source) • From version 03.00	Selection of the signal source for the position counter.
	0 Disabled	Position counter is deactivated.
	1 Feedback 1 (DI3/DI4)	Selection is not supported by the inverter i510.
	5 Internal motor model	The motor revolutions reconstructed from the internal motor model of the sensorless control (SL PSM) are counted. • The counter content will not be updated if the power section is switched off. • After restarting the power section, the counting of the last counter content is continued.
0x2C49:002 (P711.02)	Position counter: Reset mode (Position counter: Reset mode) • From version 03.00	Selection if the manual reset of the position counter is to be effected edge-controlled or status-controlled.
	0 Reset by rising edge	
	1 Reset by signal state true	



Additional functions

Position counter

Address	Name / setting range / [default setting]	Information
0x2C49:003 (P711.03)	Position counter: Actual position (Position counter: Actual position) <ul style="list-style-type: none">• Read only• From version 03.00	Mappable parameter for providing the current counter content (actual position) via network. Scaling (applies to every measuring method or encoder resolution): <ul style="list-style-type: none">• Upper 16 bits: Counted revolutions (0 ... 65535, overflow possible)• Lower 16 bits: Current position within the revolution (0 ... 65535)



14.5 Mains failure control

In case of power failure, this function can decelerate the motor and use its rotational energy to maintain the DC-bus voltage for a certain period of time. This makes it possible to continue to let the drive run during a short-term failure of the mains voltage. After mains recovery, the operating status that was active before the failure is adopted again.

Details

A failure of the mains voltage causes a continuous DC-bus voltage drop. If the mains failure control is enabled in **0x2D66:001 (P721.01)**, it will get active if the DC-bus voltage falls below the activation threshold set in **0x2D66:002 (P721.02)**.

As soon as the mains failure control is active, the motor is decelerated. Now the rotational energy of the motor is used to maintain the DC-bus voltage above the error threshold for undervoltage until the motor is decelerated to standstill in a controlled way. This process is controlled by the DC-bus voltage controller.

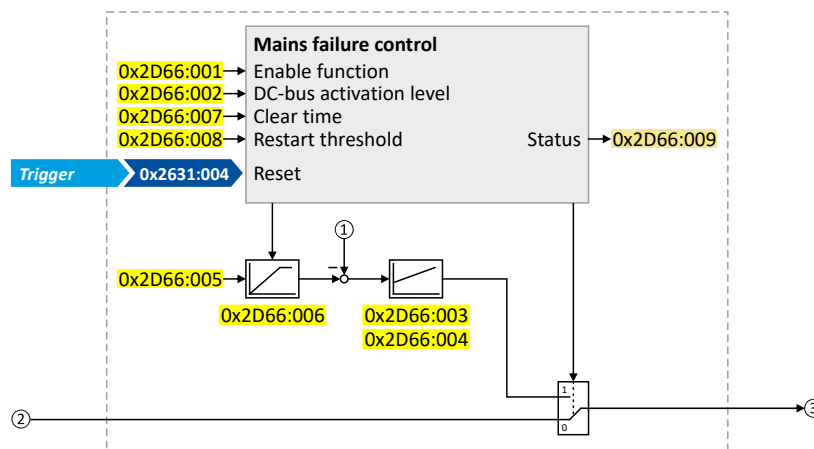

- ① Current DC-bus voltage
- ② Frequency setpoint (internal input signal)
- ③ Frequency setpoint (internal output signal for motor control)

The activation and commissioning of the mains failure control are described in detail in the following subchapters.

Parameter

Address	Name / setting range / [default setting]	Information
0x2D66:001 (P721.01)	Mains failure control: Enable function (Mains fail. ctrl: Enable function) • From version 02.00 0 Disabled 1 Enabled	1 = enable mains failure control.
0x2D66:002 (P721.02)	Mains failure control: DC-bus activation level (Mains fail. ctrl: DC-bus act.level) 60 ... [0]* ... 90 % * Default setting dependent on the model. • From version 02.00	Threshold below which the mains failure control is activated if it is enabled (0x2D66:001 (P721.01) = 1). • 100 % = nominal DC-bus voltage Recommended setting: • In general: 5 ... 10 % above the error threshold for undervoltage (display in 0x2540:003 (P208.03)). • 230-V devices: 72 % • 400/480-V devices: 82 %
0x2D66:003 (P721.03)	Mains failure control: Gain V-controller (Mains fail. ctrl: Gain V-ctrl) 0.00001 ... [0.01000] ... 0.50000 Hz/V • From version 02.00	Proportional gain of the DC-bus voltage controller.
0x2D66:004 (P721.04)	Mains failure control: Reset time V-controller (Mains fail. ctrl: Res. time V-ctrl) 5 ... [20] ... 2000 ms • From version 02.00	Reset time of the DC-bus voltage controller.



Additional functions

Mains failure control

Address	Name / setting range / [default setting]	Information
0x2D66:005 (P721.05)	Mains failure control: DC voltage setpoint (Mains fail. ctrl: DC voltage setp.) 80 ... [100] ... 110 % • From version 02.00	Voltage setpoint onto which the DC-bus voltage is to maintained. • 100 % = nominal DC-bus voltage
0x2D66:006 (P721.06)	Mains failure control: Setpoint ramp (Mains fail. ctrl: Setp. ramp) 1 ... [20] ... 16000 ms • From version 02.00	Acceleration time for the voltage setpoint set in 0x2D66:005 (P721.05) . • The set acceleration time refers to the acceleration from 0 to 100 % of the nominal DC-bus voltage.
0x2D66:007 (P721.07)	Mains failure control: Clear time (Mains fail. ctrl: Clear time) 1 ... [20] ... 60000 ms • From version 02.00	After the DC-bus voltage has exceeded the activation threshold 0x2D66:002 (P721.02) (+hysteresis) again, the time set here must be elapsed before the mains failure control is deactivated again if the restart protection is not activated (default setting).
0x2D66:008 (P721.08)	Mains failure control: Restart threshold (Mains fail. ctrl: Restart level) 0.0 ... [0.0] ... 599.0 Hz • From version 02.00	Threshold for restart protection. Below the threshold set here no restart takes place after mains recovery.
0x2D66:009 (P721.09)	Mains failure control: Status mains failure control (Mains fail. ctrl: RERT:Status) • Read only • From version 02.00	Bit coded display of the mains failure control status.
	Bit 0 Control active	1 = mains failure control active. • The DC-bus voltage has fallen below the activation threshold 0x2D66:002 (P721.02) . • The bit is reset to 0 after the DC-bus voltage has exceeded the activation threshold (+hysteresis) again and the clear time set in 0x2D66:007 (P721.07) has elapsed.
	Bit 1 I-Reset active	1 = I component of the speed controller of the motor control is reset. • Bit is set to 1 if bit 0 is set to 1 (mains failure control active). • Bit is reset to 0 if the frequency setpoint falls below 0.1 Hz.

Additional functions

Mains failure control

Activating the mains failure control



14.5.1 Activating the mains failure control

1. Set the selection "Enabled [1]" in [0x2D66:001 \(P721.01\)](#).
2. Set the activation threshold in [%] with reference to the nominal DC-bus voltage in [0x2D66:002 \(P721.02\)](#).
 - Recommended setting: 5 ... 10 % above the error threshold for undervoltage (display in [0x2540:003 \(P208.03\)](#)).
3. Set the voltage setpoint onto which the DC-bus voltage is to be maintained in [0x2D66:005 \(P721.05\)](#).
 - Recommended setting: 95 ... 100 % (of the nominal DC-bus voltage).

The mains failure control gets active with these settings if the DC-bus voltage falls below the activation threshold. The DC-bus voltage controller now generates the required operational energy from the rotational energy of the motor. The motor is decelerated by the mains failure control. Thus, the deceleration ramp is shorter than the one of a non-guided system (coasting drive).

After the mains failure control has been activated:

1. The DC-bus voltage is controlled with the acceleration time set in [0x2D66:006 \(P721.06\)](#) to the setpoint set in [0x2D66:005 \(P721.05\)](#).
2. An internally generated frequency setpoint is transferred to the motor control which enables the motor (via the frequency setpoint) to be decelerated to a frequency close to "0 Hz".
 - Starting value for the guided deceleration is the current output frequency.
 - The deceleration ramp (and hence the braking torque) results from the moment of inertia of the load machine(s), the power loss of the drive (system) and the set parameterisation.

Behaviour after mains recovery

If, after mains recovery, the DC-bus voltage has exceeded the activation threshold (+hysteresis) again, an internal timing element is started. After the time period set in [0x2D66:007 \(P721.07\)](#) has elapsed, the mains failure control is stopped if the restart protection is not activated (default setting).

▶ [Restart protection](#)  389

▶ [Fast mains recovery](#)  389



14.5.2 Restart protection

The integrated restart protection prevents a restart in the lower frequency range if the mains voltage was only interrupted briefly (mains recovery before the motor stands still).

- In the default setting [0x2D66:008 \(P721.08\)](#) = 0 Hz, the restart protection is deactivated.
- In order to activate the restart protection, set the restart threshold in [Hz] in [0x2D66:008 \(P721.08\)](#) below which no automatic start shall take place after mains recovery.
- If, in case of mains recovery, the output frequency is below the restart threshold, the restart protection gets active:
 - If the current DC-bus voltage is lower than the voltage setpoint [0x2D66:005 \(P721.05\)](#), the motor is continued to be decelerated (until frequency 0 Hz).
 - If the current DC-bus voltage is higher than the voltage setpoint [0x2D66:005 \(P721.05\)](#), the motor is accelerated in a controlled way until the output frequency exceeds the restart threshold.
- If, in case of mains recovery, the output frequency is above the restart threshold, the motor is accelerated again to the frequency setpoint. ▶ [Fast mains recovery](#) [389](#)

Diagnostic parameters:

- An active restart protection is displayed via the status bit 0 in [0x2D66:009 \(P721.09\)](#) if the mains failure control is not active.

Terminating the active restart protection

If, after mains recovery, the restart protection is active, it can be terminated by the following actions:

- Error reset via the trigger set in [0x2631:004 \(P400.04\)](#).
- Short-time inverter disable via the trigger set in [0x2631:001 \(P400.01\)](#).
- Restart via the trigger set in [0x2631:002 \(P400.02\)](#).

14.5.3 Fast mains recovery

A fast mains recovery is caused by a short interruption at the energy supply company (for instance due to a thunderstorm) and by faulty components in the supply cables (for instance slip rings).

The fast mains recovery causes a restart of the motor

- if the restart protection is deactivated ([0x2D66:008 \(P721.08\)](#) = 0 Hz, default setting)
or
- the restart protection does not get active (output frequency > [0x2D66:008 \(P721.08\)](#)).

If this behaviour is not desired, you can delay the restart by setting a switch-off time in [0x2D66:007 \(P721.07\)](#) or prevent it in connection with the restart protection. ▶ [Restart protection](#) [389](#)

Additional functions

Mains failure control
Commissioning the mains failure control



14.5.4 Commissioning the mains failure control

Commissioning should be executed with motors without load:

1. Let the motor rotate with a rated frequency of 100 %.
2. Disable the inverter and measure the time until the motor has reached standstill.
 - The time can be measured with a stop watch or similar.
 - If a motor encoder is connected to the inverter and set as feedback system for the motor control, this signal can be output at the analog output and measured with an oscilloscope.
3. Set the acceleration time for the voltage setpoint in [0x2D66:006 \(P721.06\)](#) to approx. 1/10 of the time measured before.
4. Set the switch-off time in [0x2D66:007 \(P721.07\)](#) to the time measured before.

Fine adjustment of the mains failure control

For the fine adjustment, you must repeat the following points several times:

1. An end frequency as low as possible should be reached before the inverter reaches the error threshold for undervoltage:
 - Increase the proportional gain of the DC-bus voltage controller in [0x2D66:003 \(P721.03\)](#).
 - Reduce the reset time of the DC-bus voltage controller in [0x2D66:004 \(P721.04\)](#).
2. If, during the mains failure control, monitoring for overvoltage in the DC bus is triggered:
 - Increase the reset time again in [0x2D66:004 \(P721.04\)](#) until monitoring is not triggered anymore.
 - If required, additionally reduce the voltage setpoint in [0x2D66:005 \(P721.05\)](#) onto which the DC-bus voltage is to be controlled.
3. Increasing the delay time or reducing the braking torque is only possible to a limited extent:
 - Increasing the acceleration time in [0x2D66:006 \(P721.06\)](#) reduces the initial braking torque and simultaneously increases the deceleration time.
 - Increasing the reset time of the DC-bus voltage controller in [0x2D66:004 \(P721.04\)](#) reduces the braking torque and simultaneously increases the deceleration time. If the reset time is too high, the inverter reaches the error threshold for undervoltage before standstill is reached. From this point on, the motor is not guided anymore.

Signal flow - DC-bus voltage controller

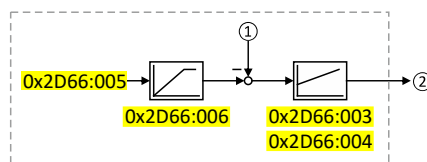

① Current DC-bus voltage

② Internally generated frequency setpoint that is transferred to the motor control in case of an active mains failure control.



14.6 Operation with UPS

This function enables the operation of a 3x400-V inverter with an uninterruptible 1x230-V power supply (UPD) to be able to operate the motor with reduced load for a certain period in the event of a power failure.



In case of UL, CSA or other North American applications with this function, the standards of the end application must be taken into account.

NOTICE

UPS operation is not suitable for a continuous operation.

Possible consequence: Device overload

► Prevent a too frequent use of this function.

Restrictions

- UPS operation is only available for 3x400/480 V devices up to 11 kW.
- For UPS operation, one reduced output current and one reduced overload are available only:
 - Output current: 60 % of the 400/480 V rated current
 - Overload: 80 %/5 min, 120 %/3 s of the 400/480 V rated current
- In order to change over to UPS operation, a minimum delay of 10 s is required.

Additional functions

Operation with UPS



Details

The following figure shows the principal connection of the UPS to the inverter. For further technical details, please contact the inverter manufacturer.

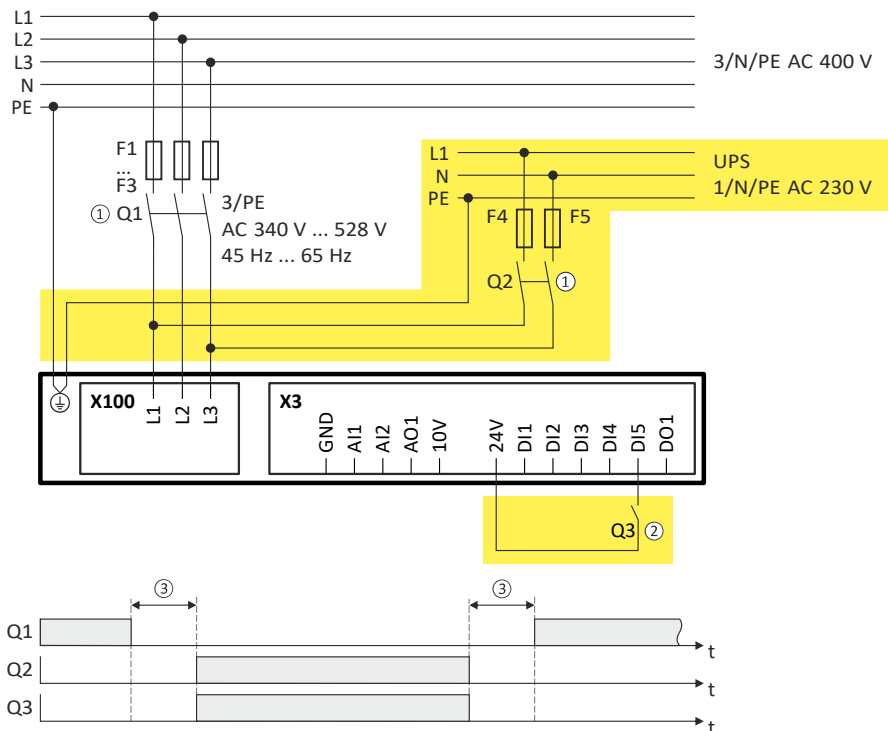

- ① A mutual locking is required for the contactors Q1 and Q2.
- ② In this example, the digital input DI5 is used to activate the UPS operation. For this purpose, the function "Activate UPS operation" [0x2631:055 \(P400.55\)](#) must be assigned to trigger "Digital input 5 [15]".
- ③ In order to change over to UPS operation, a minimum delay of 10 s is required.

The UPS operation can be alternatively activated via network. In this case, a bit of the mappable data word NetWordIN1 [0x4008:001 \(P590.01\)](#) must be assigned to the "Activate UPS operation [55]" function.

If the UPS operation is active,

- the device overload monitoring (i*t) is adapted accordingly.
- the DC limit values are reduced.
- the phase failure detection is switched off.
- the warning "UPS operation active" (error code [12672 | 0x3180](#)) is output.
- trigger "UPS operation active [118]" is set to TRUE. The trigger can be assigned to a digital output.
- bit 15 ("UPS operation active") in the inverter status word 2 [0x2833](#) is set to "1".

Notes:

- An additional limitation of speed, current, etc. can be realised via the application with the "Parameter change-over" function. [□ 370](#)

Parameter

Address	Name / setting range / [default setting]	Information
0x2631:055 (P400.55)	Function list: Activate UPS operation (Function list: Activ. UPS oper.) • Further possible settings: ▶ Trigger list □ 59	Assignment of a trigger to the "Activate UPS operation" function. Trigger = TRUE: Activate UPS operation. Trigger = FALSE: no action / deactivate function again.
	0 Not connected	No trigger assigned (trigger is constantly FALSE).



Example for operating mode

Parameter	Designation	Setting for this example
0x2631:001 (P400.01)	Enable inverter	Constant TRUE [1]
0x2631:002 (P400.02)	Run	Digital input 1 [11]
0x2631:055 (P400.55)	Activate UPS operation	Digital input 5 [15]

Input signals

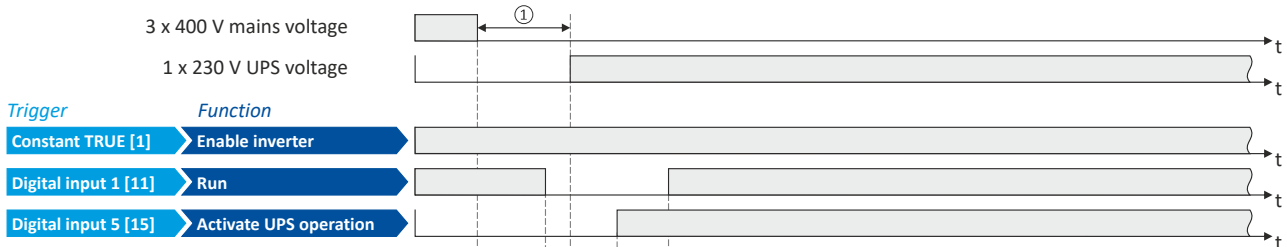

Output signals

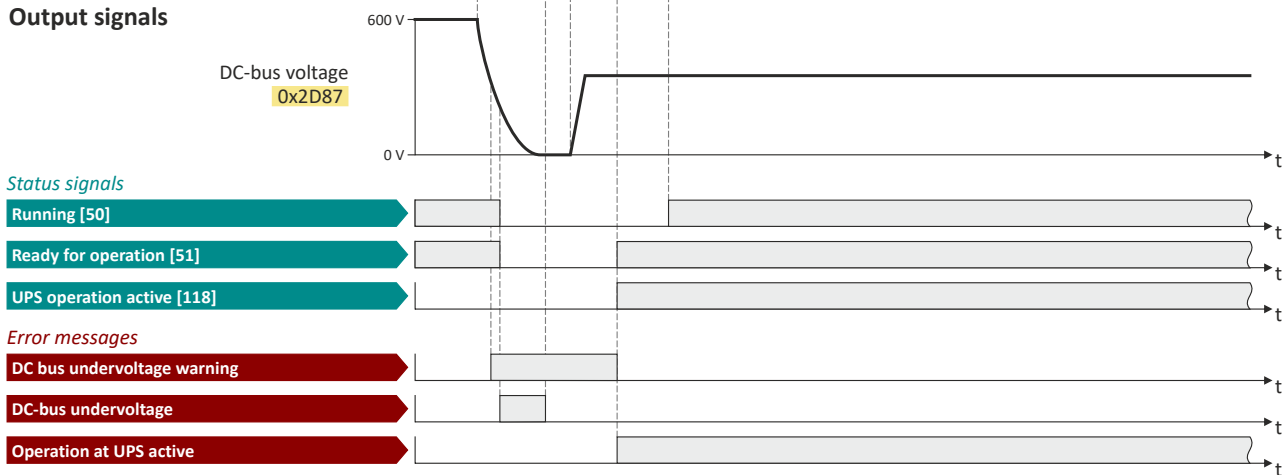

The status signals can be assigned to digital outputs. [▶ Configure digital outputs □ 247](#)

- ① In order to change over to UPS operation, a minimum delay is required.

Additional functions

Cascade function for pumps and fans



14.7 Cascade function for pumps and fans

This feature allows you to control multiple drives in fan and pump applications. The main drive is controlled by the inverter and the (maximum two) auxiliary drives are switched on directly via contactors if required. The main drive is controlled by the PID controller or another alternative setpoint source (digital/analog inputs, keypad, network) The switching cycles of the auxiliary drives are triggered depending on the actual load (PID controller).

Preconditions

The process controller has been configured. [▶ Configuring the process controller](#) 112

Possible configurations

Inverter	Drive
i5xx with standard IO (with or without network)	1 main drive (controlled via this inverter)
	2 auxiliary drives (controlled via relay/digital output)

Example with i550 cabinet frequency inverter:

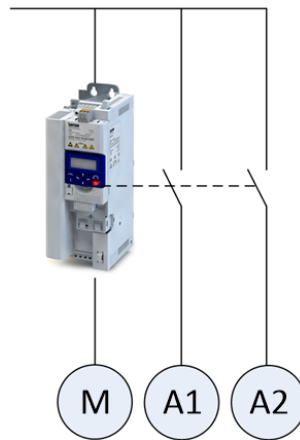

- M Main drive
- A1 Auxiliary drive 1
- A2 Auxiliary drive 2



Additional relays may be required to control the power contactors if the current/voltage range from the relay/digital output is not sufficient for direct control.



Operating modes

Two operating modes are available for the cascade function, "without ramp" and "with ramp".
The following diagrams illustrate the respective behavior.

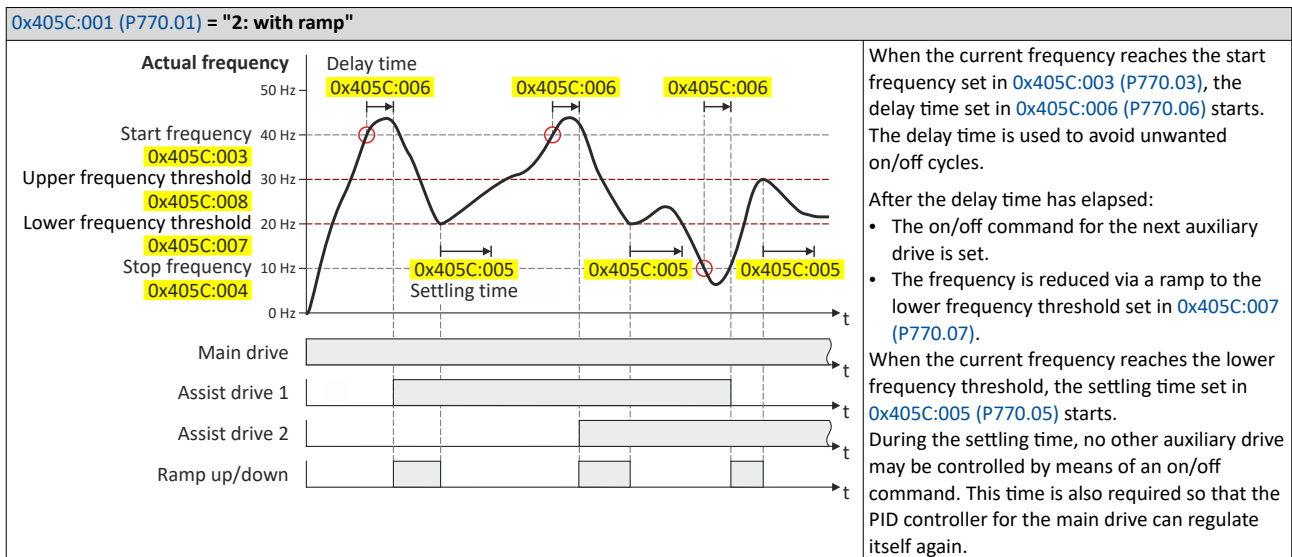
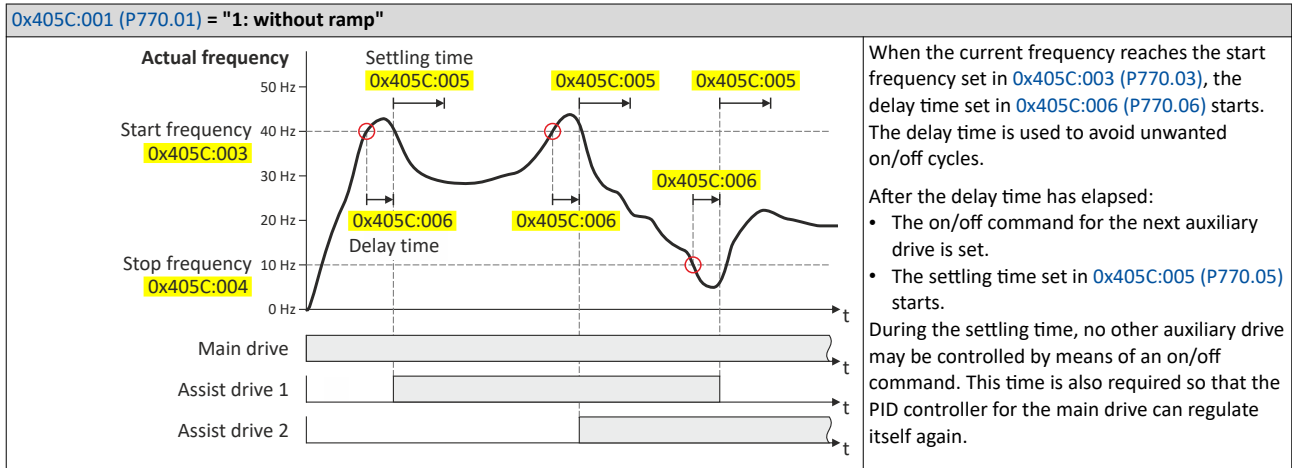



Transition mode configuration

To ensure equal operating times of both auxiliary drives, a specific transition behavior from one add-on drive to the second add-on drive can be configured by setting the "Automatic reversing time" in **0x405C:010 (P770.10)**.

The following three transition modes are possible:

Transition mode	Information	Required setting
Direct transition	The active auxiliary drive switches off, the other auxiliary drive switches on. Note that this may cause undesirable behavior in your system.	0x405C:010 (P770.10) = 0.0 s (default setting)
Sequential transition	The active auxiliary drive switches off. The other auxiliary drive only switches on after the reversing time set in 0x405C:010 (P770.10) has elapsed.	0x405C:010 (P770.10) > 0.0 s
Overlapping transition	The other auxiliary drive switches on immediately. The auxiliary drive that is already switched on does not switch off until the (negative) reversing time set in 0x405C:010 (P770.10) has elapsed.	0x405C:010 (P770.10) < 0.0 s

Example of "Sequential transition" mode

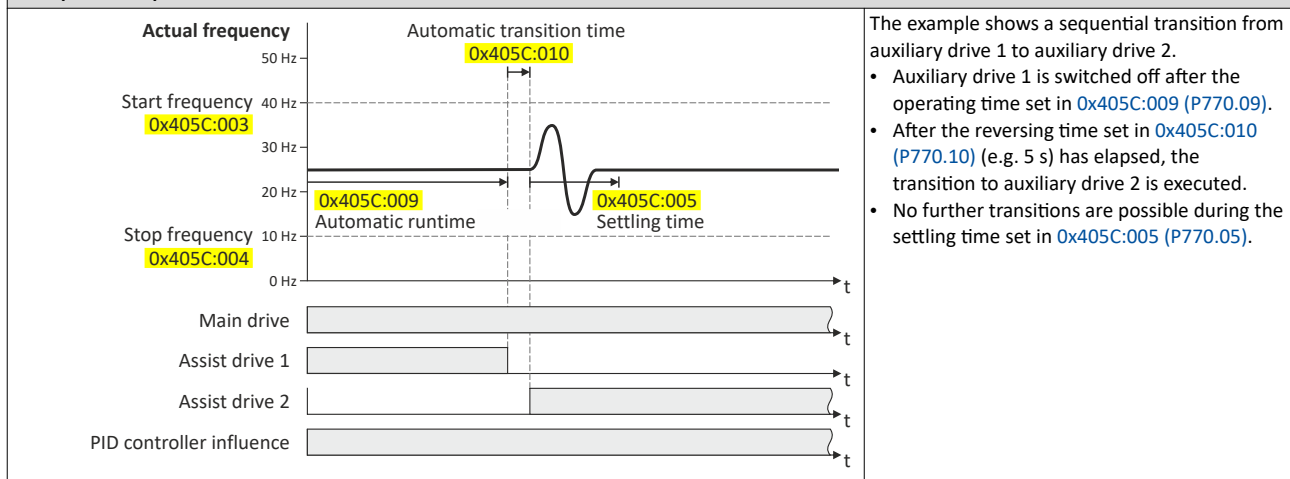

Basic settings



In the following description and in the parameter designations, the term "additional pump", which is more unambiguous for a pump cascade, is used instead of "auxiliary drive". Of course, the function can be used in the same way for a fan cascade.

Based on the default setting, we recommend the following proceeding:

- Configuring the process controller [112](#)
- Activate one or both additional pumps for the cascade function:
 - Activate additional 1: **0x2631:056 (P400.56)** = "constant TRUE [1]"
 - Activate additional pump 2: **0x2631:057 (P400.57)** = "constant TRUE [1]"
- Configure control of the additional pumps via digital output 1 or the relay:
 - Digital output 1 switches additional pump 1: **0x2634:001 (P420.01)** = "additional pump 1 [160]"
 - Digital output 1 switches additional pump 2: **0x2634:001 (P420.01)** = "additional pump 2 [161]"
 - Relay switches additional pump 1: **0x2634:002 (P420.02)** = "additional pump 1 [160]"
 - Relay switches additional pump 2: **0x2634:002 (P420.02)** = "additional pump 2 [161]"
- Set operating mode ("without ramp" or "with ramp") in **0x405C:001 (P770.01)**.
- Set transition mode by setting the automatic reversing time in **0x405C:010 (P770.10)**.
- Adjust other parameters of the function (start/stop frequency, delay time, settling time, frequency thresholds, etc.) according to the application.



Additional functions

Cascade function for pumps and fans

Parameter

Address	Name / setting range / [default setting]	Information
0x2631:056 (P400.56)	Function list: Assist pump 1 (Function list: Assist pump 1) • Further possible settings: ▶ Trigger list 59	Assignment of a trigger to the "Additional pump 1" function. Trigger = TRUE: Cascade function uses additional pump 1. Trigger = FALSE: No action.
	0 Not connected	No trigger assigned (trigger is constantly FALSE).
0x2631:057 (P400.57)	Function list: Assist pump 2 (Function list: Assist pump 2) • Further possible settings: ▶ Trigger list 59	Assignment of a trigger to the "Additional pump 2" function. Trigger = TRUE: Cascade function uses additional pump 2. Trigger = FALSE: No action.
	0 Not connected	No trigger assigned (trigger is constantly FALSE).
0x2631:058 (P400.58)	Function list: Reset operating time (Function list: Reset oper.time) • Further possible settings: ▶ Trigger list 59	Assignment of a trigger to the "Reset power-on time" function. Trigger = TRUE: Both counters for the power-on time of the additional pumps are reset to zero. Trigger = FALSE: No action.
	0 Not connected	No trigger assigned (trigger is constantly FALSE).
0x405C:001 (P770.01)	Pump cascading: Operating mode (Pump cascading: Operating mode)	Selection of the operating mode for the cascade function.
	0 Disabled	Cascade function is deactivated.
	1 Without ramp	After reaching the start or stop frequency, the cascade function has no influence on the frequency setpoint.
	2 With ramp	After reaching the start or stop frequency, the cascade function leads the frequency setpoint via a ramp to the lower or upper frequency threshold, respectively. The active auxiliary pump switches on/off: • When the start or stop frequency is reached. • When the delay time has elapsed.
0x405C:002 (P770.02)	Pump cascading: Priority at startup (Pump cascading: Prior.at startup)	
	0 Assist pump 1 1 By operating time	The auxiliary pump with the fewest operating hours starts first.
0x405C:003 (P770.03)	Pump cascading: Start frequency (Pump cascading: Start frequency) 0.0 ... [40.0] ... 599.0 Hz	
0x405C:004 (P770.04)	Pump cascading: Stop frequency (Pump cascading: Stop frequency) 0.0 ... [10.0] ... 599.0 Hz	
0x405C:005 (P770.05)	Pump cascading: Settling time (Pump cascading: Settling time) 0.0 ... [5.0] ... 3600.0 s	
0x405C:006 (P770.06)	Pump cascading: Delay time (Pump cascading: Delay time) 0.0 ... [2.0] ... 3600.0 s	
0x405C:007 (P770.07)	Pump cascading: Lower frequency threshold (Pump cascading: Low F threshold) 0.0 ... [20.0] ... 599.0 Hz	
0x405C:008 (P770.08)	Pump cascading: Upper frequency threshold (Pump cascading: Up. F threshold) 0.0 ... [30.0] ... 599.0 Hz	
0x405C:009 (P770.09)	Pump cascading: Automatic runtime (Pump cascading: Auto runtime) 0 ... [0] ... 1000 h	
0x405C:010 (P770.10)	Pump cascading: Automatic transition time (Pump cascading: Auto trans.time) -10.0 ... [0.0] ... 10.0 s	The reversing time also defines the transition mode: • Reversing time = 0.0 s: Direct transition • Reversing time > 0.0 s: Sequential transition • Reversing time < 0.0 s: Overlapping transition
0x405C:011 (P770.11)	Pump cascading: Reset operating time (Pump cascading: Reset oper.time)	1 = Both counters for the power-on time of the additional pumps are reset to zero.
	0 Disabled 1 Activate	

Additional functions

Cascade function for pumps and fans



Address	Name / setting range / [default setting]	Information
0x405C:012 (P770.12)	Pump cascading: Status word (Pump cascading: Status word) • Read only	
	Bit 0 Assist pump 1 activated	Additional pump 1 was activated for the cascade function via 0x2631:056 (P400.56) .
	Bit 1 Assist pump 2 activated	Additional pump 2 was activated for the cascade function via 0x2631:057 (P400.57) .
	Bit 3 Assist pump 1 running	
	Bit 4 Assist pump 2 running	
	Bit 6 Start frequency reached	The start frequency set in 0x405C:003 (P770.03) has been reached.
	Bit 7 Stop frequency reached	The stop frequency set in 0x405C:004 (P770.04) has been reached.
	Bit 8 Cascading overload	The maximum frequency in 0x2916 (P211.00) has been reached and no free additional pump is available. Associated error code: 65317 0xFF25
0x405C:013 (P770.13)	Pump cascading: Operating time pump 1 (Pump cascading: Operatingtime p1) • Read only: x s	
0x405C:014 (P770.14)	Pump cascading: Operating time pump 2 (Pump cascading: Operatingtime p2) • Read only: x s	



15 Using accessories

15.1 Keypad

The keypad is an easy means for the local operation, parameterisation, and diagnostics of the inverter.



Using accessories

Keypad
Keypad operating mode

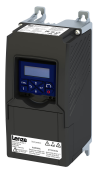

15.1.1 Keypad operating mode

After switching on the inverter, the keypad plugged in is in "Operating mode" after a short initialisation phase.

15.1.1.1 Keypad status display

In the operating mode, the keypad displays information on the status of the inverter.

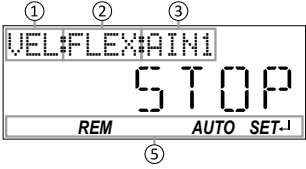
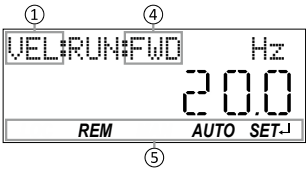
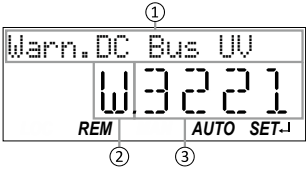
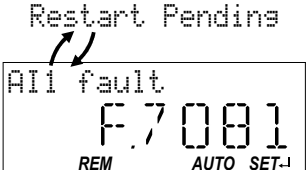
Keypad display	Display	Meaning																																											
<p>If the inverter is inhibited, the keypad shows "STOP":</p>  <p>If the inverter is enabled, the keypad shows the output frequency of the inverter:</p>  <ul style="list-style-type: none"> In the process controller mode, instead of the output frequency, the process controller setpoint is displayed. The display can be configured in 0x2864 (P703.00). The language for the keypad display is preset to "English". The language can be changed in 0x2863 (P705.00). 	<p>① Active control mode:</p> <table border="1"> <tr><td>VEL</td><td>Speed mode</td></tr> <tr><td>PID</td><td>Process controller mode</td></tr> <tr><td>TRQ</td><td>Torque mode</td></tr> <tr><td>JOG</td><td>Manual mode</td></tr> </table> <p>② Active control source:</p> <table border="1"> <tr><td>FLEX</td><td>Flexible I/O configuration</td></tr> <tr><td>KPD</td><td>Keypad</td></tr> <tr><td>KPDF</td><td>Keypad (complete control via keypad including setpoint selection)</td></tr> <tr><td>NET</td><td>Network</td></tr> </table> <p>③ Active setpoint source:</p> <table border="1"> <tr><td>AINx</td><td>Analog input x</td></tr> <tr><td>KPD</td><td>Keypad</td></tr> <tr><td>NET</td><td>Network</td></tr> <tr><td>FREQ</td><td>Digital frequency</td></tr> <tr><td>PRx</td><td>Preset setpoint x</td></tr> <tr><td>SEGx</td><td>Segment x</td></tr> <tr><td>MOP</td><td>Motor potentiometer</td></tr> </table> <p>④ Current direction of rotation:</p> <table border="1"> <tr><td>FWD</td><td>Motor is rotating forwards</td></tr> <tr><td>REV</td><td>Motor is rotating backwards</td></tr> </table> <p>⑤ Lower status line:</p> <table border="1"> <tr><td>LOC</td><td>Local keypad control active.</td></tr> <tr><td>REM</td><td>Remote control via terminals, network, etc. active.</td></tr> <tr><td>MAN</td><td>Manual setpoint selection via keypad active.</td></tr> <tr><td>AUTO</td><td>Automatic setpoint selection via terminals, network, etc. active.</td></tr> <tr><td>SET</td><td>Blinking if one parameter setting has been changed but has not been saved in the memory module with mains failure protection. Save settings: Press keypad enter key longer than 3 s.</td></tr> </table>	VEL	Speed mode	PID	Process controller mode	TRQ	Torque mode	JOG	Manual mode	FLEX	Flexible I/O configuration	KPD	Keypad	KPDF	Keypad (complete control via keypad including setpoint selection)	NET	Network	AINx	Analog input x	KPD	Keypad	NET	Network	FREQ	Digital frequency	PRx	Preset setpoint x	SEGx	Segment x	MOP	Motor potentiometer	FWD	Motor is rotating forwards	REV	Motor is rotating backwards	LOC	Local keypad control active.	REM	Remote control via terminals, network, etc. active.	MAN	Manual setpoint selection via keypad active.	AUTO	Automatic setpoint selection via terminals, network, etc. active.	SET	Blinking if one parameter setting has been changed but has not been saved in the memory module with mains failure protection. Save settings: Press keypad enter key longer than 3 s.
VEL	Speed mode																																												
PID	Process controller mode																																												
TRQ	Torque mode																																												
JOG	Manual mode																																												
FLEX	Flexible I/O configuration																																												
KPD	Keypad																																												
KPDF	Keypad (complete control via keypad including setpoint selection)																																												
NET	Network																																												
AINx	Analog input x																																												
KPD	Keypad																																												
NET	Network																																												
FREQ	Digital frequency																																												
PRx	Preset setpoint x																																												
SEGx	Segment x																																												
MOP	Motor potentiometer																																												
FWD	Motor is rotating forwards																																												
REV	Motor is rotating backwards																																												
LOC	Local keypad control active.																																												
REM	Remote control via terminals, network, etc. active.																																												
MAN	Manual setpoint selection via keypad active.																																												
AUTO	Automatic setpoint selection via terminals, network, etc. active.																																												
SET	Blinking if one parameter setting has been changed but has not been saved in the memory module with mains failure protection. Save settings: Press keypad enter key longer than 3 s.																																												
<p>If an error is pending, the keypad shows the following information:</p>  <ul style="list-style-type: none"> Faults (F) and trouble (T) are displayed continuously. Warnings (W) are only displayed every 2 seconds for a short time. 	<p>① Error text</p> <p>② Error type:</p> <table border="1"> <tr><td>F</td><td>Fault</td></tr> <tr><td>T</td><td>Trouble</td></tr> <tr><td>W</td><td>Warning</td></tr> </table> <p>③ Error code (hexadecimal)</p> <ul style="list-style-type: none"> ▶ Error codes, causes and remedies 461 ▶ Error handling 455 ▶ Error reset with keypad 402 	F	Fault	T	Trouble	W	Warning																																						
F	Fault																																												
T	Trouble																																												
W	Warning																																												
	<p>After a disturbance, a restart is possible if the error condition is not active anymore. The keypad shows this by the "Restart Pending" note. The note is displayed in a 1-second interval alternating with the error text.</p> <ul style="list-style-type: none"> ▶ Automatic restart after a fault 361 																																												



15.1.1.2 Function of keypad keys in operating mode

In the operating mode, the keypad can be used for local control and for manual setpoint selection.

Function of keypad keys in operating mode			
Key	Actuation	Condition	Action
	Briefly	Local keypad control active. Display "LOC"	Run motor.
		Remote control active Display "REM" Display "KSTOP"	Deactivate keypad triggered stop. The motor remains at standstill. Display changes from "KSTOP" to "STOP".
	Briefly	No Jog operation	Stop motor. Display "KSTOP"
	Briefly	Operating mode	Change to parameterisation mode. ▶ Keypad parameterisation mode 403
	Longer than 3 s	None (anytime possible)	Save parameter settings in the user memory of the memory module.
	Briefly	During operation	Scroll through information in the above status line.
	Briefly	Manual setpoint selection via keypad active. Display "MAN"	Change frequency setpoint.
	Briefly	Operating mode	Activate full keypad control Display "ON?" → Confirm with Control and setpoint selection can now only be carried out via keypad. Renewed clicking: Exit full keypad control. Display "OFF?" → Confirm with ▶ Keypad full control 53
	Briefly	Local keypad control active. Display "LOC"	Reversal of rotation direction. Display "REV?" → Confirm with ▶ Configure R/F and CTRL keys 426

Example: Change setpoint

If the setpoints are selected manually via keypad, the frequency setpoint can be changed in the operating mode via the arrow keys (even while the motor is running):

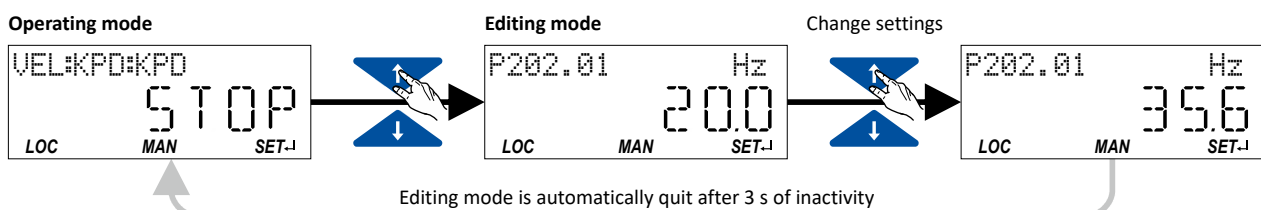

Using accessories



Keypad
Keypad operating mode



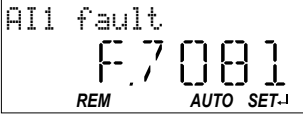

15.1.1.3 Error reset with keypad

Use the  keypad key to reset a resettable error if the error condition no longer exists and no blocking time is active.

- The "[Error codes, causes and remedies](#)" table gives the blocking time (if available) for each error. [461](#)

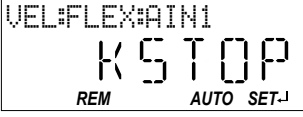
1.  

2.  

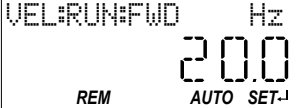

1. Press  keypad key.

The error is reset. The motor remains stopped via keypad (display "KSTOP").

2. In order to cancel the stop via keypad again: Press  keypad key.



15.1.2 Keypad parameterisation mode

In the parameterisation mode of the keypad you can have actual values of the inverter displayed for purposes of diagnostics and change settings of the inverter.

Use the **←** to change from operating mode to the parameterisation mode.

- If a write access protection is active for the inverter, the keypad automatically displays a log-in when changing to the parameterisation mode. You can either skip the log-in and thus keep the access protection active or remove it temporarily by entering a valid PIN. [▶ Write access protection](#) [□ 351](#)
- Use the **↩** to return to the operating mode.

15.1.2.1 Parameter groups

In order to provide for quick access, all parameters of the inverter are divided into different groups according to their function.

- Group 0 contains the configurable "Favorites". In the default setting these are the most common parameters for the solution of typical applications. [▶ Favorites](#) [□ 30](#)
- Based on the hundreds digit of the display code (Pxxx) you can quickly see in which group the parameter is to be found on the keypad:

Parameter	Group/name	Description
P1xx	Group 1 - Diagnostics	Diagnostic/display parameters for displaying device-internal process factors, current actual values, and status messages. ▶ Diagnostic parameters □ 444
P2xx	Group 2 - Basic setting	Setting of the mains voltage, selection of the control and setpoint source, start and stop behavior, frequency limits and ramp times. ▶ Basic setting □ 36
P3xx	Group 3 - Motor control	Configuration of the motor and motor control ▶ Configuring the motor control □ 160
P4xx	Group 4 - I/O setting	Function assignment and configuration of the inputs and outputs ▶ Start, stop and rotating direction commands □ 49 ▶ Configure digital inputs □ 237 ▶ Configure analog inputs □ 240 ▶ Configure digital outputs □ 247 ▶ Configure analog outputs □ 253
P5xx	Group 5 - Network setting	Configuration of the network (if available) ▶ Configuring the network □ 257
P6xx	Group 6 - Process controller	Configuration of the process controller ▶ Configuring the process controller □ 112
P7xx	Group 7 - Additional functions	Parameterisable additional functions ▶ Additional functions □ 367
P8xx	Group 8 - Sequencer	The "sequencer" function serves to define a programmed sequence of speed setpoints, PID setpoints or torque setpoints for the motor control. Switching to the next setpoint can be executed in a time-based or event-based manner. ▶ Sequencer □ 87

Using accessories

Keypad
Keypad parameterisation mode



15.1.2.2 Function of the keypad keys in the parameterisation mode

In the parameterisation mode of the keypad you can have actual values of the inverter displayed for purposes of diagnostics and change settings of the inverter.

Function of the keypad keys in the parameterisation mode			
Key	Actuation	Condition	Action
	Shortly	Local keypad control active. Display "LOC"	Run motor.
		Remote control active Display "REM" Display "KSTOP"	Deactivate keypad triggered stop. The motor remains at standstill. Display changes from "KSTOP" to "STOP".
	Shortly	No Jog operation	Stop motor. Display "KSTOP"
	Shortly	Parameterisation mode	Navigate to one level below. Group level → Parameter level → [SUB parameter level] → Editing mode
		Editing mode	Exit editing mode and accept new setting.
	Longer than 3 s	None (anytime possible)	Save parameter settings in the user memory of the memory module.
	Shortly	Parameterisation mode	Navigate to one level above. [SUB parameter level] → Parameter level → Group level → Operating mode
		Editing mode	Abort: Exit editing mode without accepting new setting.
	Shortly	Group level/Parameter level	Navigate: Select group/parameter.
		Editing mode	Change parameter setting.
			Without function
			Without function



Changing inverter settings by means of the keypad (general operation)

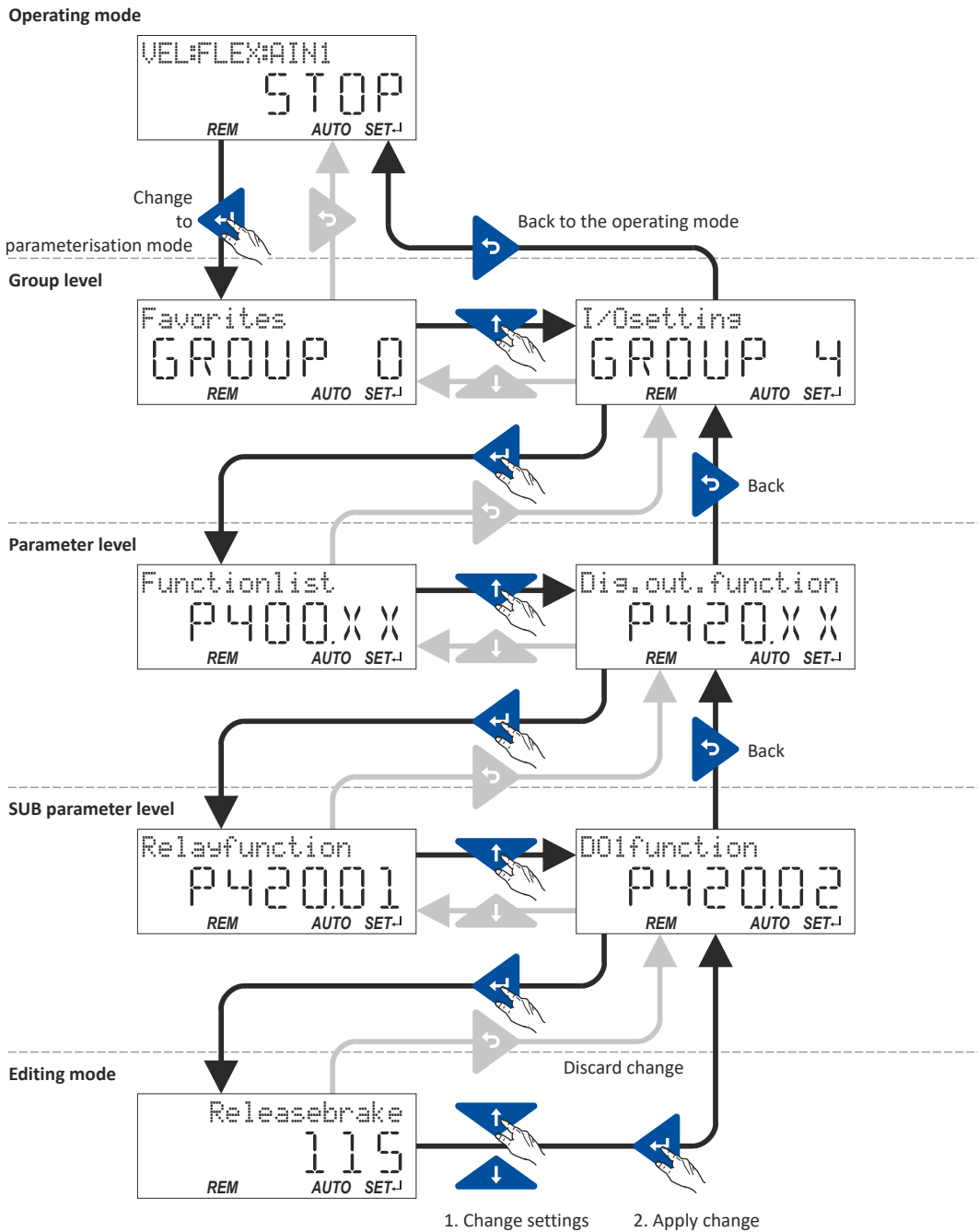

15.1.2.3 Save parameter settings with keypad

If one parameter setting has been changed with the keypad but has not been saved in the memory module with mains failure protection, the SET display is blinking.

In order to save parameter settings in the user memory of the memory module, press and hold the enter key for longer than 3 s.

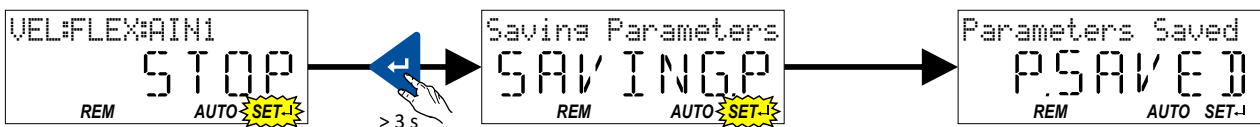

Using accessories

Keypad
Keypad parameterisation mode



15.1.2.4 Display of status words on keypad

Some diagnostics parameters contain bit-coded status words. Each single bit has a certain meaning.

Display of 16-bit status words on the keypad

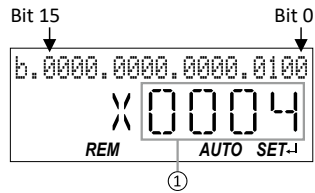

- ① Hexadecimal value

Display of 32-bit status words on the keypad

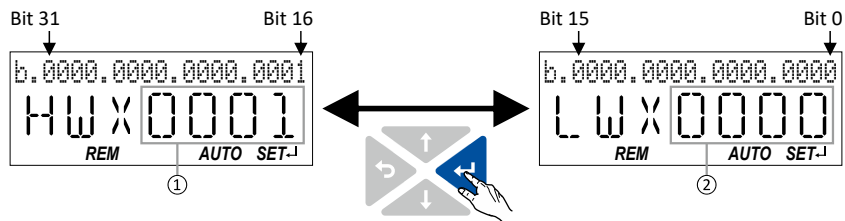

- ① Hexadecimal value High word (HW)
- ② Hexadecimal value Low word (LW)



15.1.2.5 Keypad parameter list

For commissioning or diagnostics using the keypad, all parameters of the inverter that can be accessed by means of the keypad are listed in the following "Keypad parameter list".

- The keypad parameter list is sorted in ascending order in compliance with the "display code" (Pxxx).
- In order to provide for quick access, all parameters of the inverter are divided into different groups according to their function. ▶ [Parameter groups](#) 403
- Group 0 contains the configurable "Favorites". In the default setting these are the most common parameters for the solution of typical applications. ▶ [Favorites](#) 30



A complete overview of all parameter indexes can be found in the annex in the [Parameter attribute list](#). 480

Frequently used abbreviations in the short keypad designations of the parameters:

Abbreviation	Meaning
AI	Analog input
AO	Analog output
B0, B1, ...	Bit 0, bit 1, ...
CU	Control unit
DI	Digital input
DO	Digital output
LU	Undervoltage
MOP	Motor potentiometer
NET	Network
OU	Overvoltage
PID	Process controller
PU	Power unit
QSP	Quick stop
Setp	Setpoint
WD	Watchdog

How to read the keypad parameter list:

Column	Meaning
Display code	Parameter number on the keypad. Format: Number.Subindex
Short designation	Short keypad designation limited to 16 characters.
Default setting	Default setting of the parameter.
Setting range	Possible setting range for the parameter. Format: minimum value ... maximum value [unit]
Address	Address of the parameter in the object directory. Format: Index:Subindex
Category	Functional assignment of the parameter, for example "motor control" or "CANopen".

Keypad parameter list (short overview of all parameters with display code)

Display code	Short designation	Default setting	Setting range	Address	Category
P100.00	Inv. outp. freq.	x.x Hz	- (Read only)	0x2DDD	general
P101.00	Scaled act value	x Units	- (Read only)	0x400D	general
P102.00	Freq. setpoint	x.x Hz	- (Read only)	0x2B0E	general
P103.00	Actual current	x.x %	- (Read only)	0x6078	general
P104.00	Motor current	x.x A	- (Read only)	0x2D88	general
P105.00	DC-bus voltage	x V	- (Read only)	0x2D87	general
P106.00	Motor voltage	x VAC	- (Read only)	0x2D89	general
P107.00	Actual torque	x.x %	- (Read only)	0x6077	general
P108.xx	Output power				
^L P108.01	Effective power	x.xxx kW	- (Read only)	0x2DA2:001	general

* Default setting dependent on the model.

Using accessories

Keypad
Keypad parameterisation mode



Display code	Short designation	Default setting	Setting range	Address	Category
↳ P108.02	Apparent power	x.xxx kVA	- (Read only)	0x2DA2:002	general
P109.xx	Output energy				
↳ P109.01	Motor	x.xx kWh	- (Read only)	0x2DA3:001	general
↳ P109.02	Generator	x.xx kWh	- (Read only)	0x2DA3:002	general
P110.xx	AI1 diagnostics				
↳ P110.01	AI1 terminal %	x.x %	- (Read only)	0x2DA4:001	general
↳ P110.02	AI1 scaled freq.	x.x Hz	- (Read only)	0x2DA4:002	general
↳ P110.03	AI1 scaled PID	x.xx PID unit	- (Read only)	0x2DA4:003	general
↳ P110.04	AI1 scaled torq.	x.x %	- (Read only)	0x2DA4:004	general
↳ P110.16	AI1 status	-	- (Read only)	0x2DA4:016	general
P111.xx	AI2 diagnostics				
↳ P111.01	AI2 terminal %	x.x %	- (Read only)	0x2DA5:001	general
↳ P111.02	AI2 scaled freq.	x.x Hz	- (Read only)	0x2DA5:002	general
↳ P111.03	AI2 scaled PID	x.xx PID unit	- (Read only)	0x2DA5:003	general
↳ P111.04	AI2 scaled torq.	x.x %	- (Read only)	0x2DA5:004	general
↳ P111.16	AI2 status	-	- (Read only)	0x2DA5:016	general
P112.xx	AO1 diagnostics				
↳ P112.01	AO1 Voltage	x.xx V	- (Read only)	0x2DAA:001	general
↳ P112.02	AO1 Current	x.xx mA	- (Read only)	0x2DAA:002	general
P116.00	Actual sw. freq.	-	- (Read only)	0x293A	general
P117.xx	Heatsink temp.				
↳ P117.01	Heatsink temp.	x.x °C	- (Read only)	0x2D84:001	general
P118.00	Digital inputs	-	- (Read only)	0x60FD	general
P119.00	Keypad status	-	- (Read only)	0x2DAC	general
P120.00	Int. HW states	-	- (Read only)	0x2DAD	general
P121.xx	PID diagnostics				
↳ P121.01	PID setpoint	x.xx PID unit	- (Read only)	0x401F:001	general
↳ P121.02	PID process var.	x.xx PID unit	- (Read only)	0x401F:002	general
↳ P121.03	PID status	-	- (Read only)	0x401F:003	general
P123.00	Mot. i2t utilis.	x %	- (Read only)	0x2D4F	MCTRL
P125.xx	Inverter diag.				
↳ P125.01	Active control	-	- (Read only)	0x282B:001	general
↳ P125.02	Active setpoint	-	- (Read only)	0x282B:002	general
↳ P125.03	Keypad LCD stat.	-	- (Read only)	0x282B:003	general
↳ P125.04	Drive mode	-	- (Read only)	0x282B:004	general
↳ P125.05	Netw. contr.reg.	-	- (Read only)	0x282B:005	general
↳ P125.06	Netw. setp.reg.	-	- (Read only)	0x282B:006	general
P126.xx	Status words				
↳ P126.01	Cause of disable	-	- (Read only)	0x282A:001	general
↳ P126.02	Cause of QSP	-	- (Read only)	0x282A:002	general
↳ P126.03	Cause of stop	-	- (Read only)	0x282A:003	general
↳ P126.05	Device status	-	- (Read only)	0x282A:005	general
P135.xx	Device utilisat.				
↳ P135.04	ixt utilisation	x %	- (Read only)	0x2D40:004	general
↳ P135.05	Error response	Fault [3]	Selection list	0x2D40:005	general
P140.xx	Sequencer diag				
↳ P140.01	Active Step	-	- (Read only)	0x2DAE:001	Sequencer
↳ P140.02	StepTime elapsed	x.x s	- (Read only)	0x2DAE:002	Sequencer
↳ P140.03	StepTime remain	x.x s	- (Read only)	0x2DAE:003	Sequencer
↳ P140.04	Steps complete	-	- (Read only)	0x2DAE:004	Sequencer
↳ P140.05	Steps remain	-	- (Read only)	0x2DAE:005	Sequencer
↳ P140.06	Active sequence	-	- (Read only)	0x2DAE:006	Sequencer
↳ P140.07	Active segment	-	- (Read only)	0x2DAE:007	Sequencer
↳ P140.08	SeqTime remain %	x %	- (Read only)	0x2DAE:008	Sequencer

* Default setting dependent on the model.



Using accessories

Keypad
Keypad parameterisation mode

Display code	Short designation	Default setting	Setting range	Address	Category
L P140.09	SeqTime remain	x.x s	- (Read only)	0x2DAE:009	Sequencer
P150.00	Error code	-	- (Read only)	0x603F	general
P151.xx	Life-diagnosis				
L P151.01	Operating time	x s	- (Read only)	0x2D81:001	general
L P151.02	Power-on time	x s	- (Read only)	0x2D81:002	general
L P151.03	CU oper. time	x ns	- (Read only)	0x2D81:003	general
L P151.04	Switching cycles	-	- (Read only)	0x2D81:004	general
L P151.05	Relay cycles	-	- (Read only)	0x2D81:005	general
L P151.06	Short-circ.count	-	- (Read only)	0x2D81:006	general
L P151.07	Earthfault count	-	- (Read only)	0x2D81:007	general
L P151.08	Clamp active	-	- (Read only)	0x2D81:008	general
L P151.09	Fan oper. time	x s	- (Read only)	0x2D81:009	general
P155.xx	Fault memory				
P155.00	Error memory	-	- (Read only)	0x2006:000	general
P190.xx	Device data				
L P190.01	Product code	-	- (Read only)	0x2000:001	general
L P190.02	Serial number	-	- (Read only)	0x2000:002	general
L P190.04	CU firmware ver.	-	- (Read only)	0x2000:004	general
L P190.05	CU firmware type	-	- (Read only)	0x2000:005	general
L P190.06	CU bootldr ver.	-	- (Read only)	0x2000:006	general
L P190.07	CU bootldr type	-	- (Read only)	0x2000:007	general
L P190.08	OBD version	-	- (Read only)	0x2000:008	general
L P190.10	PU firmware ver.	-	- (Read only)	0x2000:010	general
L P190.11	PU firmware type	-	- (Read only)	0x2000:011	general
L P190.12	PU bootldr ver.	-	- (Read only)	0x2000:012	general
L P190.13	PU bootldr type	-	- (Read only)	0x2000:013	general
L P190.14	Mod. firmware	-	- (Read only)	0x2000:014	general
L P190.15	Com. FW rev no.	-	- (Read only)	0x2000:015	general
L P190.16	ComBootldrRevNo	-	- (Read only)	0x2000:016	general
L P190.17	CU FW subtype	-	- (Read only)	0x2000:017	general
P191.00	Device name	"My Device"	Text	0x2001	general
P197.00	Protect. status	-	- (Read only)	0x2040	general
P198.00	Status load. par	-	- (Read only)	0x2827	general
P200.00	Control select.	Flexible I/O [0]	Selection list	0x2824	general
P201.xx	Stnd. setpoints				
L P201.01	Freq. setp. src.	Analog input 1 [2]	Selection list	0x2860:001	general
L P201.02	PID setp. src.	Keypad [1]	Selection list	0x2860:002	general
L P201.03	Torque setp.src.	Analog input 1 [2]	Selection list	0x2860:003	general
P202.xx	Keypad setpoints				
L P202.01	KP freq.setpoint	20.0 Hz	0.0 ... 599.0 Hz	0x2601:001	general
L P202.02	KP PID setpoint	0.00 PID unit	-300.00 ... 300.00 PID unit	0x2601:002	general
L P202.03	Torque setp.	100.0 %	-400.0 ... 400.0 %	0x2601:003	general
P203.xx	Start/stop cfg				
L P203.01	Start method	Normal [0]	Selection list	0x2838:001	MCTRL
L P203.02	Start at powerup	Off [0]	Selection list	0x2838:002	general
L P203.03	Stop method	Standard ramp [1]	Selection list	0x2838:003	general
P208.xx	Mains settings				
L P208.01	Mains voltage	230 Veff [0]	Selection list	0x2540:001	general
L P208.02	LU warn. thresh.	0 V *	0 ... 1000 V	0x2540:002	general
L P208.03	LU error thresh.	x V	- (Read only)	0x2540:003	general
L P208.04	LU reset thresh.	x V	- (Read only)	0x2540:004	general
L P208.05	OU warn. thresh.	0 V *	0 ... 1000 V	0x2540:005	general
L P208.06	OU error thresh.	x V	- (Read only)	0x2540:006	general
L P208.07	OU reset thresh.	x V	- (Read only)	0x2540:007	general

* Default setting dependent on the model.

Using accessories

Keypad
Keypad parameterisation mode



Display code	Short designation	Default setting	Setting range	Address	Category
P210.00	Min. frequency	0.0 Hz	0.0 ... 599.0 Hz	0x2915	general
P211.00	Max. frequency	Device for 50-Hz mains: 50.0 Hz Device for 60-Hz mains: 60.0 Hz	0.0 ... 599.0 Hz	0x2916	general
P220.00	Accelerat.time 1	5.0 s	0.0 ... 3600.0 s	0x2917	general
P221.00	Decelerat.time 1	5.0 s	0.0 ... 3600.0 s	0x2918	general
P222.00	Accelerat.time 2	5.0 s	0.0 ... 3600.0 s	0x2919	general
P223.00	Decelerat.time 2	5.0 s	0.0 ... 3600.0 s	0x291A	general
P224.00	Ramp 2 thresh.	0.0 Hz	0.0 ... 599.0 Hz	0x291B	general
P225.00	QSP dec. time	1.0 s	0.0 ... 3600.0 s	0x291C	general
P226.xx	S-ramp char.				
└ P226.01	Smoothing factor	0.0 %	0.0 ... 100.0 %	0x291E:001	general
└ P226.03	Stop threshold	10.0 %	0.0 ... 100.0 %	0x291E:003	general
P230.xx	Optical tracking				
└ P230.01	Start detection	Stop [0]	Selection list	0x2021:001	general
└ P230.02	Blink. duration	5 s	0 ... 3600 s	0x2021:002	general
P300.00	Motor ctrl mode	VFC open loop [6]	Selection list	0x2C00	MCTRL
P301.00	Operation mode	MS: Velocitymode [-2]	Selection list	0x6060	MCTRL
P302.00	V/f charac.shape	Linear [0]	Selection list	0x2B00	MCTRL
P303.xx	V/f shape data				
└ P303.01	Base voltage	230 V *	0 ... 5000 V	0x2B01:001	MCTRL
└ P303.02	Base frequency	Device for 50-Hz mains: 50 Hz * Device for 60-Hz mains: 60 Hz *	0 ... 1500 Hz	0x2B01:002	MCTRL
└ P303.03	Midpoint voltage	0 V	0 ... 5000 V	0x2B01:003	MCTRL
└ P303.04	Midpoint freq	0 Hz	0 ... 1500 Hz	0x2B01:004	MCTRL
P304.00	Limit. rotation	Both rot. direct [1]	Selection list	0x283A	general
P305.00	Switching freq.	0 *	1 ... 33	0x2939	general
P306.xx	Inv. load char.				
└ P306.01	Duty selection	Heavy Duty [0]	Selection list	0x2D43:001	general
P308.xx	Motor overload				
└ P308.01	Max.load.for 60s	150 %	30 ... 200 %	0x2D4B:001	MCTRL
└ P308.02	Speed comp.	On [0]	Selection list	0x2D4B:002	MCTRL
└ P308.03	Response	Fault [3]	Selection list	0x2D4B:003	general
P310.xx	Mot.phase.fail.				
└ P310.01	Response	No response [0]	Selection list	0x2D45:001	general
└ P310.02	Current thresh.	5.0 %	1.0 ... 25.0 %	0x2D45:002	MCTRL
└ P310.03	Voltage thresh.	10.0 V	0.0 ... 100.0 V	0x2D45:003	MCTRL
P315.xx	Slip compens.				
└ P315.01	Slip: gain	100.00 %	-200.00 ... 200.00 %	0x2B09:001	MCTRL
└ P315.02	Filter time	100 ms	1 ... 6000 ms	0x2B09:002	MCTRL
P316.xx	V/f boosts				
└ P316.01	Fixed V/f boost	2.5 % *	0.0 ... 20.0 %	0x2B12:001	MCTRL
└ P316.02	Dynam. V/f boost	0.0 %	0.0 ... 20.0 %	0x2B12:002	general
P317.xx	Skip frequencies				
└ P317.01	Skip frequency 1	0.0 Hz	0.0 ... 599.0 Hz	0x291F:001	general
└ P317.02	Skip bandwidth 1	0.0 Hz	0.0 ... 10.0 Hz	0x291F:002	general
└ P317.03	Skip frequency 2	0.0 Hz	0.0 ... 599.0 Hz	0x291F:003	general
└ P317.04	Skip bandwidth 2	0.0 Hz	0.0 ... 10.0 Hz	0x291F:004	general
└ P317.05	Skip frequency 3	0.0 Hz	0.0 ... 599.0 Hz	0x291F:005	general
└ P317.06	Skip bandwidth 3	0.0 Hz	0.0 ... 10.0 Hz	0x291F:006	general
P318.xx	Oscillat. damp.				
└ P318.01	Gain	150 %	-400 ... 400 %	0x2B0A:001	MCTRL

* Default setting dependent on the model.

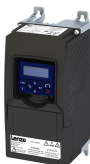

Using accessories

Keypad
Keypad parameterisation mode

Display code	Short designation	Default setting	Setting range	Address	Category
L P318.02	Filter time	30 ms	1 ... 600 ms	0x2B0A:002	MCTRL
P319.00	Field weak thold	0.0 Hz	-599.0 ... 599.0 Hz	0x2B0C	MCTRL
P319.00	Field weak thold	-40.0 Hz	-599.0 ... 599.0 Hz	0x2B0C	MCTRL
P320.xx	Motor parameters				
L P320.04	Rated speed	Device for 50-Hz mains: 1450 rpm Device for 60-Hz mains: 1750 rpm	50 ... 50000 rpm	0x2C01:004	MCTRL
L P320.05	Rated frequency	Device for 50-Hz mains: 50.0 Hz Device for 60-Hz mains: 60.0 Hz	1.0 ... 1000.0 Hz	0x2C01:005	MCTRL
L P320.06	Rated power	0.25 kW *	0.00 ... 655.35 kW	0x2C01:006	MCTRL
L P320.07	Rated voltage	230 V *	0 ... 65535 V	0x2C01:007	MCTRL
L P320.08	Cosine phi	0.80	0.00 ... 1.00	0x2C01:008	MCTRL
P322.00	Max. motor speed	6075 rpm	0 ... 480000 rpm	0x6080	MCTRL
P323.00	Rated mot.curr.	1.700 A *	0.001 ... 500.000 A	0x6075	MCTRL
P324.00	Max. current	200.0 %	0.0 ... 3000.0 %	0x6073	MCTRL
P325.00	Rated mot torque	1.650 Nm *	0.001 ... 4294967.295 Nm	0x6076	MCTRL
P326.00	Max. torque	250.0 %	0.0 ... 3000.0 %	0x6072	MCTRL
L P327.04	Identify mot.	0	0 ... 1	0x2822:004	general
L P327.05	Calibrate mot.	0	0 ... 1	0x2822:005	general
P329.xx	MaxTrq.Monitor				
L P329.01	Response	No response [0]	Selection list	0x2D67:001	MCTRL
L P329.02	Triggering delay	0.000 s	0.000 ... 10.000 s	0x2D67:002	MCTRL
P330.xx	VFC-ECO				
L P330.01	Min. voltage	20 %	20 ... 100 %	0x2B0D:001	MCTRL
L P330.06	Cos Phi actual	-	-(Read only)	0x2B0D:006	MCTRL
P332.xx	Speed controller				
L P332.01	Gain	0.00193 Nm/rpm *	0.00000 ... 20000.00000 Nm/rpm	0x2900:001	MCTRL
L P332.02	Reset time	80.0 ms *	1.0 ... 6000.0 ms	0x2900:002	MCTRL
P333.xx	V/f I _{max} contr.				
L P333.01	Gain	0.284 Hz/A *	0.000 ... 1000.000 Hz/A	0x2B08:001	MCTRL
L P333.02	Reset time	2.3 ms *	1.0 ... 2000.0 ms	0x2B08:002	MCTRL
P334.xx	Current contr.				
L P334.01	Gain	42.55 V/A *	0.00 ... 750.00 V/A	0x2942:001	MCTRL
L P334.02	Reset time	4.50 ms *	0.01 ... 2000.00 ms	0x2942:002	MCTRL
P335.xx	Moment of inert.				
L P335.01	Motor inertia	3.70 kg cm ² *	0.00 ... 20000000.00 kg cm ²	0x2910:001	MCTRL
L P335.02	Scal load inert.	0.00 kg cm ²	0.00 ... 20000000.00 kg cm ²	0x2910:002	MCTRL
P336.xx	Torque setpoint				
L P336.02	Ramp time	1.0 s	0.0 ... 60.0 s	0x2948:002	general
P337.xx	Trq. lim. source				
L P337.01	Pos. torqlim src	Max torque [0]	Selection list	0x2949:001	general
L P337.02	Neg. torqlim src	(-) Max torque [0]	Selection list	0x2949:002	general
L P337.03	Act postorqlim	x.x %	-(Read only)	0x2949:003	general
L P337.04	Act negtorqlim	x.x %	-(Read only)	0x2949:004	general
P340.xx	Speed limitation				
L P340.01	Upper limit	0 vel. unit	-2147483647 ... 2147483647 vel. unit	0x2946:001	general
L P340.02	Lower limit	0 vel. unit	-2147483647 ... 2147483647 vel. unit	0x2946:002	general
L P340.03	Uppspeerd lim src	Max. frequency [0]	Selection list	0x2946:003	general
L P340.04	Lowspeerd lim src	(-) Max. freq. [0]	Selection list	0x2946:004	general

* Default setting dependent on the model.

Using accessories

Keypad
Keypad parameterisation mode



Display code	Short designation	Default setting	Setting range	Address	Category
L P340.05	Upper freq.limit	Device for 50-Hz mains: 50.0 Hz Device for 60-Hz mains: 60.0 Hz	-1000.0 ... 1000.0 Hz	0x2946:005	general
L P340.06	Lower freq.limit	Device for 50-Hz mains: -50.0 Hz Device for 60-Hz mains: -60.0 Hz	-1000.0 ... 1000.0 Hz	0x2946:006	general
L P340.07	Act uppspeed lim	x.x Hz	- (Read only)	0x2946:007	general
L P340.08	Act lowspped lim	x.x Hz	- (Read only)	0x2946:008	general
P350.xx	Overspeed monit.				
L P350.01	Threshold	8000 rpm	50 ... 50000 rpm	0x2D44:001	MCTRL
L P350.02	Response	Fault [3]	Selection list	0x2D44:002	general
P351.xx	ASM motor par.				
L P351.01	Rotor resistance	8.8944 Ω *	0.0000 ... 200.0000 Ω	0x2C02:001	MCTRL
L P351.02	Mutual induct.	381.9 mH *	0.0 ... 50000.0 mH	0x2C02:002	MCTRL
L P351.03	Magn. current	0.96 A *	0.00 ... 500.00 A	0x2C02:003	MCTRL
L P351.04	Slip frequency	x.x Hz	- (Read only)	0x2C02:004	MCTRL
P352.xx	PSM motor par.				
L P352.01	BEMF constant	41.8 V/1000rpm	0.0 ... 100000.0 V/1000rpm	0x2C03:001	MCTRL
L P352.05	D-axis Ld	20.000 mH *	0.000 ... 500.000 mH	0x2C03:005	MCTRL
L P352.06	Q-axis Lq	20.000 mH *	0.000 ... 500.000 mH	0x2C03:006	MCTRL
P353.xx	Overcurr. monit.				
L P353.01	Threshold	6.8 A *	0.0 ... 1000.0 A	0x2D46:001	MCTRL
L P353.02	Response	Fault [3]	Selection list	0x2D46:002	general
P354.00	Voltage reserve	5 %	0 ... 20 %	0x29E4	MCTRL
P400.xx	Function list				
L P400.01	Enable inverter	TRUE [1]	Trigger list 59	0x2631:001	general
L P400.02	Run	Digital input 1 [11]	Trigger list 59	0x2631:002	general
L P400.03	Quick stop	Not connected [0]	Trigger list 59	0x2631:003	general
L P400.04	Reset fault	Digital input 2 [12]	Trigger list 59	0x2631:004	general
L P400.05	DC braking	Not connected [0]	Trigger list 59	0x2631:005	general
L P400.06	Start forward	Not connected [0]	Trigger list 59	0x2631:006	general
L P400.07	Start reverse	Not connected [0]	Trigger list 59	0x2631:007	general
L P400.08	Run forward	Not connected [0]	Trigger list 59	0x2631:008	general
L P400.09	Run reverse	Not connected [0]	Trigger list 59	0x2631:009	general
L P400.10	Jog foward	Not connected [0]	Trigger list 59	0x2631:010	general
L P400.11	Jog reverse	Not connected [0]	Trigger list 59	0x2631:011	general
L P400.12	Keypad control	Not connected [0]	Trigger list 59	0x2631:012	general
L P400.13	Reverse rot.dir.	Digital input 3 [13]	Trigger list 59	0x2631:013	general
L P400.14	Setp: AI1	Not connected [0]	Trigger list 59	0x2631:014	general
L P400.15	Setp: AI2	Not connected [0]	Trigger list 59	0x2631:015	general
L P400.16	Setp: Keypad	Not connected [0]	Trigger list 59	0x2631:016	general
L P400.17	Setp: Network	Not connected [0]	Trigger list 59	0x2631:017	general
L P400.18	Setp: Preset b0	Digital input 4 [14]	Trigger list 59	0x2631:018	general
L P400.19	Setp: Preset b1	Digital input 5 [15]	Trigger list 59	0x2631:019	general
L P400.20	Setp: Preset b2	Not connected [0]	Trigger list 59	0x2631:020	general
L P400.21	Setp: Preset b3	Not connected [0]	Trigger list 59	0x2631:021	general
L P400.23	MOP up	Not connected [0]	Trigger list 59	0x2631:023	general
L P400.24	MOP down	Not connected [0]	Trigger list 59	0x2631:024	general
L P400.25	Setp: MOP	Not connected [0]	Trigger list 59	0x2631:025	general
L P400.26	Setp: Segment b0	Not connected [0]	Trigger list 59	0x2631:026	Sequencer
L P400.27	Setp: Segment b1	Not connected [0]	Trigger list 59	0x2631:027	Sequencer
L P400.28	Setp: Segment b2	Not connected [0]	Trigger list 59	0x2631:028	Sequencer
L P400.29	Setp: Segment b3	Not connected [0]	Trigger list 59	0x2631:029	Sequencer

* Default setting dependent on the model.

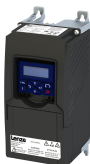

Using accessories

Keypad
Keypad parameterisation mode

Display code	Short designation	Default setting	Setting range	Address	Category
L P400.30	Seq: Run/abort	Not connected [0]	Trigger list 59	0x2631:030	Sequencer
L P400.31	Seq: Start	Not connected [0]	Trigger list 59	0x2631:031	Sequencer
L P400.32	Seq: Next step	Not connected [0]	Trigger list 59	0x2631:032	Sequencer
L P400.33	Seq: Pause	Not connected [0]	Trigger list 59	0x2631:033	Sequencer
L P400.34	Seq: Suspense	Not connected [0]	Trigger list 59	0x2631:034	Sequencer
L P400.35	Seq: Stop	Not connected [0]	Trigger list 59	0x2631:035	Sequencer
L P400.36	Seq: Abort	Not connected [0]	Trigger list 59	0x2631:036	Sequencer
L P400.37	Network control	Not connected [0]	Trigger list 59	0x2631:037	general
L P400.39	Activ. ramp 2	Not connected [0]	Trigger list 59	0x2631:039	general
L P400.40	Load param.set	Not connected [0]	Trigger list 59	0x2631:040	general
L P400.41	Sel. paramset b0	Not connected [0]	Trigger list 59	0x2631:041	general
L P400.42	Sel. paramset b1	Not connected [0]	Trigger list 59	0x2631:042	general
L P400.43	Fault 1	Not connected [0]	Trigger list 59	0x2631:043	general
L P400.44	Fault 2	Not connected [0]	Trigger list 59	0x2631:044	general
L P400.45	PID off	Not connected [0]	Trigger list 59	0x2631:045	general
L P400.46	PID output=0	Not connected [0]	Trigger list 59	0x2631:046	general
L P400.47	PID-I inhibited	Not connected [0]	Trigger list 59	0x2631:047	general
L P400.48	PID-Inf ramp on	TRUE [1]	Trigger list 59	0x2631:048	general
L P400.49	Open brake	Not connected [0]	Trigger list 59	0x2631:049	general
L P400.50	Seq: Select. b0	Not connected [0]	Trigger list 59	0x2631:050	Sequencer
L P400.51	Seq: Select. b1	Not connected [0]	Trigger list 59	0x2631:051	Sequencer
L P400.52	Seq: Select. b2	Not connected [0]	Trigger list 59	0x2631:052	Sequencer
L P400.53	Seq: Select. b3	Not connected [0]	Trigger list 59	0x2631:053	Sequencer
L P400.54	PosCounter reset	Not connected [0]	Trigger list 59	0x2631:054	general
L P400.55	Activ. UPS oper.	Not connected [0]	Trigger list 59	0x2631:055	general
L P400.56	Assist pump 1	Not connected [0]	Trigger list 59	0x2631:056	
L P400.57	Assist pump 2	Not connected [0]	Trigger list 59	0x2631:057	
L P400.58	Reset oper.time	Not connected [0]	Trigger list 59	0x2631:058	
P410.xx	DI settings				
L P410.01	Assertion level	HIGH active [1]	Selection list	0x2630:001	general
L P410.02	Input function	Digital Input [0]	Selection list	0x2630:002	general
P411.xx	DI inversion				
L P411.01	DI1 inversion	Not inverted [0]	Selection list	0x2632:001	general
L P411.02	DI2 inversion	Not inverted [0]	Selection list	0x2632:002	general
L P411.03	DI3 inversion	Not inverted [0]	Selection list	0x2632:003	general
L P411.04	DI4 inversion	Not inverted [0]	Selection list	0x2632:004	general
L P411.05	DI5 inversion	Not inverted [0]	Selection list	0x2632:005	general
L P411.06	DI6 inversion	Not inverted [0]	Selection list	0x2632:006	Appl. I/O
L P411.07	DI7 inversion	Not inverted [0]	Selection list	0x2632:007	Appl. I/O
P412.00	Freq. threshold	0.0 Hz	0.0 ... 599.0 Hz	0x4005	general
P413.00	MOP startmode	Last value [0]	Selection list	0x4003	general
P414.xx	MOP start value				
L P414.01	Frequency	0.0 Hz	0.0 ... 599.0 Hz	0x4004:001	general
L P414.02	PID value	0.00 PID unit	-300.00 ... 300.00 PID unit	0x4004:002	general
L P414.03	Torque	0.0 %	0.0 ... 1000.0 %	0x4004:003	general
P420.xx	Dig.out.function				
L P420.01	Relay function	Rdy for operat. [51]	Selection list	0x2634:001	general
L P420.02	DO1 function	Release brake [115]	Selection list	0x2634:002	general
L P420.10	NetWordOUT1.00	Rdy for operat. [51]	Selection list	0x2634:010	general
L P420.11	NetWordOUT1.01	Not connected [0]	Selection list	0x2634:011	general
L P420.12	NetWordOUT1.02	Operat. enabled [52]	Selection list	0x2634:012	general
L P420.13	NetWordOUT1.03	Fault [56]	Selection list	0x2634:013	general
L P420.14	NetWordOUT1.04	Not connected [0]	Selection list	0x2634:014	general
L P420.15	NetWordOUT1.05	Quick stop [54]	Selection list	0x2634:015	general

* Default setting dependent on the model.

Using accessories

Keypad
Keypad parameterisation mode



Display code	Short designation	Default setting	Setting range	Address	Category
L P420.16	NetWordOUT1.06	Running [50]	Selection list	0x2634:016	general
L P420.17	NetWordOUT1.07	Device warning [58]	Selection list	0x2634:017	general
L P420.18	NetWordOUT1.08	Not connected [0]	Selection list	0x2634:018	general
L P420.19	NetWordOUT1.09	Not connected [0]	Selection list	0x2634:019	general
L P420.20	NetWordOUT1.10	Speed - setp=act [72]	Selection list	0x2634:020	general
L P420.21	NetWordOUT1.11	At current limit [78]	Selection list	0x2634:021	general
L P420.22	NetWordOUT1.12	Actual speed=0 [71]	Selection list	0x2634:022	general
L P420.23	NetWordOUT1.13	Rot.dir.reversed [69]	Selection list	0x2634:023	general
L P420.24	NetWordOUT1.14	Release brake [115]	Selection list	0x2634:024	general
L P420.25	NetWordOUT1.15	Inv.dis.safety [55]	Selection list	0x2634:025	general
P421.xx	DO inversion				
L P421.01	Relay inverted	Not inverted [0]	Selection list	0x2635:001	general
L P421.02	DO1 inversion	Not inverted [0]	Selection list	0x2635:002	general
P430.xx	Analog input 1				
L P430.01	AI1 input range	0 ... 10 VDC [0]	Selection list	0x2636:001	general
L P430.02	AI1 freq @ min	0.0 Hz	-1000.0 ... 1000.0 Hz	0x2636:002	general
L P430.03	AI1 freq @ max	Device for 50-Hz mains: 50.0 Hz Device for 60-Hz mains: 60.0 Hz	-1000.0 ... 1000.0 Hz	0x2636:003	general
L P430.04	AI1 PID @ min	0.00 PID unit	-300.00 ... 300.00 PID unit	0x2636:004	general
L P430.05	AI1 PID @ max	100.00 PID unit	-300.00 ... 300.00 PID unit	0x2636:005	general
L P430.06	AI1 filter time	10 ms	0 ... 10000 ms	0x2636:006	general
L P430.07	AI1 dead band	0.0 %	0.0 ... 100.0 %	0x2636:007	general
L P430.08	AI1 monit.level	0.0 %	-100.0 ... 100.0 %	0x2636:008	general
L P430.09	Monitoring cond.	IN < threshold [0]	Selection list	0x2636:009	general
L P430.10	AI1 error resp.	Fault [3]	Selection list	0x2636:010	general
L P430.11	Min. torque	0.0 %	-400.0 ... 400.0 %	0x2636:011	general
L P430.12	Max. torque	100.0 %	-400.0 ... 400.0 %	0x2636:012	general
P431.xx	Analog input 2				
L P431.01	AI2 input range	0 ... 10 VDC [0]	Selection list	0x2637:001	general
L P431.02	AI2 freq @ min	0.0 Hz	-1000.0 ... 1000.0 Hz	0x2637:002	general
L P431.03	AI2 freq @ max	Device for 50-Hz mains: 50.0 Hz Device for 60-Hz mains: 60.0 Hz	-1000.0 ... 1000.0 Hz	0x2637:003	general
L P431.04	AI2 PID @ min	0.00 PID unit	-300.00 ... 300.00 PID unit	0x2637:004	general
L P431.05	AI2 PID @ max	100.00 PID unit	-300.00 ... 300.00 PID unit	0x2637:005	general
L P431.06	AI2 filter time	10 ms	0 ... 10000 ms	0x2637:006	general
L P431.07	AI2 dead band	0.0 %	0.0 ... 100.0 %	0x2637:007	general
L P431.08	AI2 monit.level	0.0 %	-100.0 ... 100.0 %	0x2637:008	general
L P431.09	Monitoring cond.	IN < threshold [0]	Selection list	0x2637:009	general
L P431.10	AI2 error resp.	Fault [3]	Selection list	0x2637:010	general
L P431.11	Min. torque	0.0 %	-400.0 ... 400.0 %	0x2637:011	general
L P431.12	Max. torque	100.0 %	-400.0 ... 400.0 %	0x2637:012	general
P440.xx	Analog output 1				
L P440.01	AO1 outp. range	0 ... 10 VDC [1]	Selection list	0x2639:001	general
L P440.02	AO1 function	Outp. frequency [1]	Selection list	0x2639:002	general
L P440.03	AO1 min. signal	0	-2147483648 ... 2147483647	0x2639:003	general
L P440.04	AO1 max. signal	1000	-2147483648 ... 2147483647	0x2639:004	general
P450.xx	Freq. presets				
L P450.01	Freq. preset 1	20.0 Hz	0.0 ... 599.0 Hz	0x2911:001	general
L P450.02	Freq. preset 2	40.0 Hz	0.0 ... 599.0 Hz	0x2911:002	general

* Default setting dependent on the model.

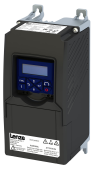

Using accessories

Keypad
Keypad parameterisation mode

Display code	Short designation	Default setting	Setting range	Address	Category
L P450.03	Freq. preset 3	Device for 50-Hz mains: 50.0 Hz Device for 60-Hz mains: 60.0 Hz	0.0 ... 599.0 Hz	0x2911:003	general
L P450.04	Freq. preset 4	0.0 Hz	0.0 ... 599.0 Hz	0x2911:004	general
L P450.05	Freq. preset 5	0.0 Hz	0.0 ... 599.0 Hz	0x2911:005	general
L P450.06	Freq. preset 6	0.0 Hz	0.0 ... 599.0 Hz	0x2911:006	general
L P450.07	Freq. preset 7	0.0 Hz	0.0 ... 599.0 Hz	0x2911:007	general
L P450.08	Freq. preset 8	0.0 Hz	0.0 ... 599.0 Hz	0x2911:008	general
L P450.09	Freq. preset 9	0.0 Hz	0.0 ... 599.0 Hz	0x2911:009	general
L P450.10	Freq. preset 10	0.0 Hz	0.0 ... 599.0 Hz	0x2911:010	general
L P450.11	Freq. preset 11	0.0 Hz	0.0 ... 599.0 Hz	0x2911:011	general
L P450.12	Freq. preset 12	0.0 Hz	0.0 ... 599.0 Hz	0x2911:012	general
L P450.13	Freq. preset 13	0.0 Hz	0.0 ... 599.0 Hz	0x2911:013	general
L P450.14	Freq. preset 14	0.0 Hz	0.0 ... 599.0 Hz	0x2911:014	general
L P450.15	Freq. preset 15	0.0 Hz	0.0 ... 599.0 Hz	0x2911:015	general
P451.xx	PID presets				
L P451.01	PID preset 1	0.00 PID unit	-300.00 ... 300.00 PID unit	0x4022:001	general
L P451.02	PID preset 2	0.00 PID unit	-300.00 ... 300.00 PID unit	0x4022:002	general
L P451.03	PID preset 3	0.00 PID unit	-300.00 ... 300.00 PID unit	0x4022:003	general
L P451.04	PID preset 4	0.00 PID unit	-300.00 ... 300.00 PID unit	0x4022:004	general
L P451.05	PID preset 5	0.00 PID unit	-300.00 ... 300.00 PID unit	0x4022:005	general
L P451.06	PID preset 6	0.00 PID unit	-300.00 ... 300.00 PID unit	0x4022:006	general
L P451.07	PID preset 7	0.00 PID unit	-300.00 ... 300.00 PID unit	0x4022:007	general
L P451.08	PID preset 8	0.00 PID unit	-300.00 ... 300.00 PID unit	0x4022:008	general
P452.xx	Torque presets				
L P452.01	Torque preset 1	100.0 %	-400.0 ... 400.0 %	0x2912:001	general
L P452.02	Torque preset 2	100.0 %	-400.0 ... 400.0 %	0x2912:002	general
L P452.03	Torque preset 3	100.0 %	-400.0 ... 400.0 %	0x2912:003	general
L P452.04	Torque preset 4	100.0 %	-400.0 ... 400.0 %	0x2912:004	general
L P452.05	Torque preset 5	100.0 %	-400.0 ... 400.0 %	0x2912:005	general
L P452.06	Torque preset 6	100.0 %	-400.0 ... 400.0 %	0x2912:006	general
L P452.07	Torque preset 7	100.0 %	-400.0 ... 400.0 %	0x2912:007	general
L P452.08	Torque preset 8	100.0 %	-400.0 ... 400.0 %	0x2912:008	general
P500.xx	Module ID				
L P500.01	Active module ID	-	-(Read only)	0x231F:001	general
L P500.02	Module ID conn.	-	-(Read only)	0x231F:002	general
P505.xx	NetWordIN1 fct.				
L P505.01	NetWordIN1.00	Not active [0]	Selection list	0x400E:001	general
L P505.02	NetWordIN1.01	Not active [0]	Selection list	0x400E:002	general
L P505.03	NetWordIN1.02	Quick stop [3]	Selection list	0x400E:003	general
L P505.04	NetWordIN1.03	Not active [0]	Selection list	0x400E:004	general
L P505.05	NetWordIN1.04	Run forward [8]	Selection list	0x400E:005	general
L P505.06	NetWordIN1.05	Setp: Preset b0 [18]	Selection list	0x400E:006	general
L P505.07	NetWordIN1.06	Setp: Preset b1 [19]	Selection list	0x400E:007	general
L P505.08	NetWordIN1.07	Reset error [4]	Selection list	0x400E:008	general
L P505.09	NetWordIN1.08	Not active [0]	Selection list	0x400E:009	general
L P505.10	NetWordIN1.09	DC braking [5]	Selection list	0x400E:010	general
L P505.11	NetWordIN1.10	Not active [0]	Selection list	0x400E:011	general
L P505.12	NetWordIN1.11	Not active [0]	Selection list	0x400E:012	general
L P505.13	NetWordIN1.12	Reverse rot.dir. [13]	Selection list	0x400E:013	general
L P505.14	NetWordIN1.13	Not active [0]	Selection list	0x400E:014	general
L P505.15	NetWordIN1.14	Not active [0]	Selection list	0x400E:015	general
L P505.16	NetWordIN1.15	Not active [0]	Selection list	0x400E:016	general

* Default setting dependent on the model.

Using accessories

Keypad
Keypad parameterisation mode



Display code	Short designation	Default setting	Setting range	Address	Category
P508.00	CANopen comm.	No action [0]	Selection list	0x2300	CANopen
P508.00	Modbus comm.	No action [0]	Selection list	0x2320	Modbus RTU
P510.xx	CANopen sett.				
↳ P510.01	Node ID	1	1 ... 127	0x2301:001	CANopen
↳ P510.02	Baud rate	500 kbps [5]	Selection list	0x2301:002	CANopen
↳ P510.03	Slave/Master	Slave [0]	Selection list	0x2301:003	CANopen
↳ P510.04	Start rem. delay	3000 ms	0 ... 65535 ms	0x2301:004	CANopen
↳ P510.05	SDO2 channel	Not active [0]	Selection list	0x2301:005	CANopen
↳ P510.06	COB-IDConfig PDO	Base + node-ID [0]	Selection list	0x2301:006	CANopen
↳ P510.07	COB-IDConfigSDO2	Freely config. [1]	Selection list	0x2301:007	CANopen
P510.xx	Modbus sett.				
↳ P510.01	Node ID	1	1 ... 247	0x2321:001	Modbus RTU
↳ P510.02	Baud rate	Automatic [0]	Selection list	0x2321:002	Modbus RTU
↳ P510.03	Data format	Automatic [0]	Selection list	0x2321:003	Modbus RTU
↳ P510.04	Min. resp. time	0 ms	0 ... 1000 ms	0x2321:004	Modbus RTU
P511.xx	CANopen diag.				
↳ P511.01	Active node ID	-	-(Read only)	0x2302:001	CANopen
↳ P511.02	Active baud rate	-	-(Read only)	0x2302:002	CANopen
P511.xx	Modbus diag.				
↳ P511.01	Active node ID	-	-(Read only)	0x2322:001	Modbus RTU
↳ P511.02	Active baud rate	-	-(Read only)	0x2322:002	Modbus RTU
↳ P511.03	Data format	-	-(Read only)	0x2322:003	Modbus RTU
P515.00	Time-out status	-	-(Read only)	0x2307	CANopen
P515.xx	Modbus monit.				
↳ P515.01	Resp. Time-out	Fault [3]	Selection list	0x2858:001	Modbus RTU
↳ P515.02	Time-out time	2.0 s	0.0 ... 300.0 s	0x2858:002	Modbus RTU
P516.00	CANopen status	-	-(Read only)	0x2308	CANopen
P517.00	CAN contr.status	-	-(Read only)	0x2309	CANopen
P518.00	CAN errorcounter	-	-(Read only)	0x230B	CANopen
P520.xx	Cons. heartbeat				
P520.00	Highest subindex	-	-(Read only)	0x1016:000	CANopen
↳ P520.01	Cons. heartbeat1	0x00000000	0x00000000 ... 0x00FFFFFF	0x1016:001	CANopen
↳ P520.02	Cons. heartbeat2	0x00000000	0x00000000 ... 0x00FFFFFF	0x1016:002	CANopen
↳ P520.03	Cons. heartbeat3	0x00000000	0x00000000 ... 0x00FFFFFF	0x1016:003	CANopen
↳ P520.04	Cons. heartbeat4	0x00000000	0x00000000 ... 0x00FFFFFF	0x1016:004	CANopen
P522.00	Prod. heartbeat	0 ms	0 ... 65535 ms	0x1017	CANopen
P530.xx	Para. mapping				
↳ P530.01 ... 24	Parameter 1 ... Parameter 24	0x00000000	0x00000000 ... 0xFFFFF00	0x232B:001 ... 0x232B:024	Modbus RTU
P531.xx	Reg. assigned				
↳ P531.01 ... 24	Register 1 ... Register 24	-	-(Read only)	0x232C:001 ... 0x232C:024	Modbus RTU
P532.00	Verificationcode	-	-(Read only)	0x232D	Modbus RTU
P540.xx	RPDO1 config.				
↳ P540.01	COB-ID	0x00000200	0x00000000 ... 0xFFFFFFFF	0x1400:001	CANopen
↳ P540.02	Transm. type	255	0 ... 255	0x1400:002	CANopen
↳ P540.05	Event timer	100 ms	0 ... 65535 ms	0x1400:005	CANopen
P541.xx	RPDO2 config.				
↳ P541.01	COB-ID	0x80000300	0x00000000 ... 0xFFFFFFFF	0x1401:001	CANopen
↳ P541.02	Transm. type	255	0 ... 255	0x1401:002	CANopen
↳ P541.05	Event timer	100 ms	0 ... 65535 ms	0x1401:005	CANopen
P542.xx	RPDO3 config.				
↳ P542.01	COB-ID	0x80000400	0x00000000 ... 0xFFFFFFFF	0x1402:001	CANopen
↳ P542.02	Transm. type	255	0 ... 255	0x1402:002	CANopen

* Default setting dependent on the model.



Using accessories

Keypad
Keypad parameterisation mode

Display code	Short designation	Default setting	Setting range	Address	Category
L P542.05	Event timer	100 ms	0 ... 65535 ms	0x1402:005	CANopen
P550.xx	TPDO1 config.				
L P550.01	COB-ID	0x40000180	0x00000001 ... 0xFFFFFFFF	0x1800:001	CANopen
L P550.02	Transm. type	255	0 ... 255	0x1800:002	CANopen
L P550.03	Inhibit time	0.0 ms	0.0 ... 6553.5 ms	0x1800:003	CANopen
L P550.05	Event timer	20 ms	0 ... 65535 ms	0x1800:005	CANopen
P551.xx	TPDO2 config.				
L P551.01	COB-ID	0xC0000280	0x00000001 ... 0xFFFFFFFF	0x1801:001	CANopen
L P551.02	Transm. type	255	0 ... 255	0x1801:002	CANopen
L P551.03	Inhibit time	0.0 ms	0.0 ... 6553.5 ms	0x1801:003	CANopen
L P551.05	Event timer	0 ms	0 ... 65535 ms	0x1801:005	CANopen
P552.xx	TPDO3 config.				
L P552.01	COB-ID	0xC0000380	0x00000001 ... 0xFFFFFFFF	0x1802:001	CANopen
L P552.02	Transm. type	255	0 ... 255	0x1802:002	CANopen
L P552.03	Inhibit time	0.0 ms	0.0 ... 6553.5 ms	0x1802:003	CANopen
L P552.05	Event timer	0 ms	0 ... 65535 ms	0x1802:005	CANopen
P580.xx	CAN statistics				
L P580.01	PDO1 received	-	-(Read only)	0x230A:001	CANopen
L P580.02	PDO2 received	-	-(Read only)	0x230A:002	CANopen
L P580.03	PDO3 received	-	-(Read only)	0x230A:003	CANopen
L P580.05	PDO1 transmitted	-	-(Read only)	0x230A:005	CANopen
L P580.06	PDO2 transmitted	-	-(Read only)	0x230A:006	CANopen
L P580.07	PDO3 transmitted	-	-(Read only)	0x230A:007	CANopen
L P580.09	SDO1 counter	-	-(Read only)	0x230A:009	CANopen
L P580.10	SDO2 counter	-	-(Read only)	0x230A:010	CANopen
P580.xx	Modbus statistic				
L P580.01	Mess. received	-	-(Read only)	0x232A:001	Modbus RTU
L P580.02	Val. mess. rec.	-	-(Read only)	0x232A:002	Modbus RTU
L P580.03	Mess. w. exc.	-	-(Read only)	0x232A:003	Modbus RTU
L P580.04	Mess. w. errors	-	-(Read only)	0x232A:004	Modbus RTU
L P580.05	Messages sent	-	-(Read only)	0x232A:005	Modbus RTU
P583.xx	Rx data diagn.				
L P583.01	Rx data offset	0	0 ... 240	0x232E:001	Modbus RTU
L P583.02	Last RxD byte0	-	-(Read only)	0x232E:002	Modbus RTU
L P583.03	Last RxD byte1	-	-(Read only)	0x232E:003	Modbus RTU
L P583.04	Last RxD byte2	-	-(Read only)	0x232E:004	Modbus RTU
L P583.05	Last RxD byte3	-	-(Read only)	0x232E:005	Modbus RTU
L P583.06	Last RxD byte4	-	-(Read only)	0x232E:006	Modbus RTU
L P583.07	Letzt RxD-Byte5	-	-(Read only)	0x232E:007	Modbus RTU
L P583.08	Last RxD byte6	-	-(Read only)	0x232E:008	Modbus RTU
L P583.09	Last RxD byte7	-	-(Read only)	0x232E:009	Modbus RTU
L P583.10	Last RxD byte8	-	-(Read only)	0x232E:010	Modbus RTU
L P583.11	Last RxD byte9	-	-(Read only)	0x232E:011	Modbus RTU
L P583.12	Last RxD byte10	-	-(Read only)	0x232E:012	Modbus RTU
L P583.13	Last RxD byte11	-	-(Read only)	0x232E:013	Modbus RTU
L P583.14	Last RxD byte12	-	-(Read only)	0x232E:014	Modbus RTU
L P583.15	Last RxD byte13	-	-(Read only)	0x232E:015	Modbus RTU
L P583.16	Last RxD byte14	-	-(Read only)	0x232E:016	Modbus RTU
L P583.17	Last RxD byte15	-	-(Read only)	0x232E:017	Modbus RTU
P585.xx	Tx data diagn.				
L P585.01	Tx data offset	0	0 ... 240	0x232F:001	Modbus RTU
L P585.02	Last TxD byte0	-	-(Read only)	0x232F:002	Modbus RTU
L P585.03	Last TxD Byte1	-	-(Read only)	0x232F:003	Modbus RTU
L P585.04	Last TxD byte2	-	-(Read only)	0x232F:004	Modbus RTU

* Default setting dependent on the model.

Using accessories

Keypad
Keypad parameterisation mode



Display code	Short designation	Default setting	Setting range	Address	Category
L P585.05	Last TxD byte3	-	-(Read only)	0x232F:005	Modbus RTU
L P585.06	Last TxD byte4	-	-(Read only)	0x232F:006	Modbus RTU
L P585.07	Last TxD byte5	-	-(Read only)	0x232F:007	Modbus RTU
L P585.08	Last TxD byte6	-	-(Read only)	0x232F:008	Modbus RTU
L P585.09	Last TxD byte7	-	-(Read only)	0x232F:009	Modbus RTU
L P585.10	Last TxD byte8	-	-(Read only)	0x232F:010	Modbus RTU
L P585.11	Last TxD byte9	-	-(Read only)	0x232F:011	Modbus RTU
L P585.12	Last TxD byte10	-	-(Read only)	0x232F:012	Modbus RTU
L P585.13	Last TxD byte11	-	-(Read only)	0x232F:013	Modbus RTU
L P585.14	Last TxD byte12	-	-(Read only)	0x232F:014	Modbus RTU
L P585.15	Last TxD byte13	-	-(Read only)	0x232F:015	Modbus RTU
L P585.16	Last TxD byte14	-	-(Read only)	0x232F:016	Modbus RTU
L P585.17	Last TxD byte15	-	-(Read only)	0x232F:017	Modbus RTU
P590.xx	NetWordINx				
L P590.01	NetWordIN1	0x0000	0x0000 ... 0xFFFF	0x4008:001	general
L P590.02	NetWordIN2	0x0000	0x0000 ... 0xFFFF	0x4008:002	general
L P590.03	NetWordIN3	0.0 %	0.0 ... 100.0 %	0x4008:003	general
L P590.04	NetWordIN4	0.0 %	0.0 ... 100.0 %	0x4008:004	general
L P590.05	NetWordIN5	0.0 %	-100.0 ... 100.0 %	0x4008:005	general
P591.xx	NetWordOUTx				
L P591.01	NetWordOUT1	-	-(Read only)	0x400A:001	general
L P591.02	NetWordOUT2	-	-(Read only)	0x400A:002	general
P592.xx	Process data IN				
L P592.01	AC control word	0x0000	0x0000 ... 0xFFFF	0x400B:001	general
L P592.02	LECOM ctrl word	0x0000	0x0000 ... 0xFFFF	0x400B:002	general
L P592.03	Net.freq. 0.1	0.0 Hz	0.0 ... 599.0 Hz	0x400B:003	general
L P592.04	Net.setp. speed	0 rpm	0 ... 50000 rpm	0x400B:004	general
L P592.05	Net.freq. 0.01	0.00 Hz	0.00 ... 599.00 Hz	0x400B:005	general
L P592.06	Veloc. mode setp	0.0 Hz	-599.0 ... 599.0 Hz	0x400B:006	general
L P592.07	PID setpoint	0.00 PID unit	-300.00 ... 300.00 PID unit	0x400B:007	general
L P592.08	Torque mode setp	0 Nm	-32768 ... 32767 Nm	0x400B:008	general
L P592.09	Torque scaling	0	-128 ... 127	0x400B:009	general
L P592.11	PID feedback	0.00 PID unit	-300.00 ... 300.00 PID unit	0x400B:011	general
L P592.12	NetSetfreq0.02Hz	0 Hz	-29950 ... 29950 Hz	0x400B:012	general
L P592.13	N.FrqSet+/-16384	0	-16384 ... 16384	0x400B:013	general
P593.xx	Process data OUT				
L P593.01	AC status word	-	-(Read only)	0x400C:001	general
L P593.02	LECOM stat. word	-	-(Read only)	0x400C:002	general
L P593.03	Frequency (0.1)	x.x Hz	-(Read only)	0x400C:003	general
L P593.04	Motor speed	x rpm	-(Read only)	0x400C:004	general
L P593.05	Drive status	-	-(Read only)	0x400C:005	general
L P593.06	Frequency 0.01	x.xx Hz	-(Read only)	0x400C:006	general
L P593.07	Torque scaled	-	-(Read only)	0x400C:007	general
L P593.08	Frequency 0.02Hz	Hz	-(Read only)	0x400C:008	general
L P593.09	Freq. [+/-16384]	-	-(Read only)	0x400C:009	general
P595.xx	PAM monitoring				
L P595.02	Keep alive reg.	0	0 ... 65535	0x2552:002	general
L P595.03	Time-out time	10.0 s	0.0 ... 6553.5 s	0x2552:003	general
L P595.04	Reaction	No response [0]	Selection list	0x2552:004	general
L P595.05	Action	No action [0]	Selection list	0x2552:005	general
L P595.06	PAM status	-	-(Read only)	0x2552:006	general
L P595.07	WLAN reset t.out	0 s	0 ... 65535 s	0x2552:007	general
P600.xx	PID setup				
L P600.01	Operating mode	Inhibited [0]	Selection list	0x4020:001	general

* Default setting dependent on the model.

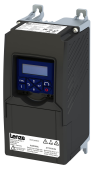

Using accessories

Keypad
Keypad parameterisation mode

Display code	Short designation	Default setting	Setting range	Address	Category
L P600.02	PID process var.	Analog input 1 [1]	Selection list	0x4020:002	general
L P600.03	PID speed range	100 %	0 ... 100 %	0x4020:003	general
L P600.04	PID line speed	w/o speed.add. [0]	Selection list	0x4020:004	general
L P600.05	Min speed lim	-100.0 %	-100.0 ... 100.0 %	0x4020:005	general
L P600.06	Max speed lim	100.0 %	-100.0 ... 100.0 %	0x4020:006	general
P601.00	PID P-component	5.0 %	0.0 ... 1000.0 %	0x4048	general
P602.00	PID I- component	400 ms	10 ... 6000 ms	0x4049	general
P603.00	PID D-component	0.0 s	0.0 ... 20.0 s	0x404A	general
P604.00	PID setp.ramp	20.0 s	0.0 ... 100.0 s	0x404B	general
P605.xx	PID setp. limit				
L P605.01	Minimum setpoint	-300.00 PID unit	-300.00 ... 300.00 PID unit	0x404E:001	general
L P605.02	Maximum setpoint	300.00 PID unit	-300.00 ... 300.00 PID unit	0x404E:002	general
P606.xx	PID speed op.				
L P606.01	Accel. time	1.0 s	0.0 ... 3600.0 s	0x4021:001	general
L P606.02	Decel. time	1.0 s	0.0 ... 3600.0 s	0x4021:002	general
P607.xx	PID influence				
L P607.01	Activation time	5.0 s	0.0 ... 999.9 s	0x404C:001	general
L P607.02	Mask out time	5.0 s	0.0 ... 999.9 s	0x404C:002	general
P608.xx	PID alarms				
L P608.01	MIN alarm thrsh.	0.00 PID unit	-300.00 ... 300.00 PID unit	0x404D:001	general
L P608.02	MAX alarm thrsh.	100.00 PID unit	-300.00 ... 300.00 PID unit	0x404D:002	general
L P608.03	Bandw. feedback	2.00 %	0.00 ... 100.00 %	0x404D:003	general
P610.xx	PID sleep mode				
L P610.01	Activation	Disabled [0]	Selection list	0x4023:001	general
L P610.02	Stop method	Coasting [0]	Selection list	0x4023:002	general
L P610.03	Freq. thresh.	0.0 Hz	0.0 ... 599.0 Hz	0x4023:003	general
L P610.04	Feedback thresh.	0.00 PID unit	-300.00 ... 300.00 PID unit	0x4023:004	general
L P610.05	Delay time	0.0 s	0.0 ... 300.0 s	0x4023:005	general
L P610.06	Recovery	Setp. > P610.3 [0]	Selection list	0x4023:006	general
L P610.07	Bandwidth	0.00 PID unit	0.00 ... 300.00 PID unit	0x4023:007	general
L P610.08	Recovery thresh.	0.00 PID unit	-300.00 ... 300.00 PID unit	0x4023:008	general
P615.xx	Auto-rinsing				
L P615.01	Rinsing in idle	Inhibited [0]	Selection list	0x4024:001	general
L P615.02	Rinse interval	30.0 min	0.0 ... 6000.0 min	0x4024:002	general
L P615.03	Rinse speed	0.0 Hz	-599.0 ... 599.0 Hz	0x4024:003	general
L P615.04	Rinse period	0.0 s	0.0 ... 6000.0 s	0x4024:004	general
P700.xx	Device commands				
L P700.01	Load def. sett.	Off / ready [0]	Selection list	0x2022:001	general
L P700.03	Save user data	Off / ready [0]	Selection list	0x2022:003	general
L P700.04	Load user data	Off / ready [0]	Selection list	0x2022:004	general
L P700.05	Load OEM data	Off / ready [0]	Selection list	0x2022:005	general
L P700.06	Save OEM data	Off / ready [0]	Selection list	0x2022:006	general
L P700.07	Load par. set 1	Off / ready [0]	Selection list	0x2022:007	general
L P700.08	Load par. set 2	Off / ready [0]	Selection list	0x2022:008	general
L P700.09	Load par. set 3	Off / ready [0]	Selection list	0x2022:009	general
L P700.10	Load par. set 4	Off / ready [0]	Selection list	0x2022:010	general
L P700.11	Save par. set 1	Off / ready [0]	Selection list	0x2022:011	general
L P700.12	Save par. set 2	Off / ready [0]	Selection list	0x2022:012	general
L P700.13	Save par. set 3	Off / ready [0]	Selection list	0x2022:013	general
L P700.14	Save par. set 4	Off / ready [0]	Selection list	0x2022:014	general
L P700.15	Delete logbook	Off / ready [0]	Selection list	0x2022:015	general
P701.00	KP setp. incr.	1	1 ... 100	0x2862	general
P702.00	Scal.speed fact.	0.00	0.00 ... 650.00	0x4002	general
P703.00	KP status displ.	0x00000000	0x00000000 ... 0xFFFFFFF0	0x2864	general

* Default setting dependent on the model.

Using accessories

Keypad
Keypad parameterisation mode



Display code	Short designation	Default setting	Setting range	Address	Category
P704.xx	DC braking				
↳ P704.01	Current	0.0 %	0.0 ... 200.0 %	0x2B84:001	MCTRL
↳ P704.02	Hold time autom.	0.0 s	0.0 ... 1000.0 s	0x2B84:002	general
↳ P704.03	Threshold autom.	0.0 Hz	0.0 ... 599.0 Hz	0x2B84:003	general
↳ P704.04	Demagnet. time	100 %	0 ... 150 %	0x2B84:004	general
↳ P704.05	Def. demag. time	x ms	- (Read only)	0x2B84:005	general
↳ P704.06	Inverter disable	Deactivated [0]	Selection list	0x2B84:006	general
P705.00	KP language	English [1]	Selection list	0x2863	general
P706.xx	Brake management				
↳ P706.01	Operating mode	Rfg stop (RFGS) [1]	Selection list	0x2541:001	general
↳ P706.02	Active threshold	x V	- (Read only)	0x2541:002	general
↳ P706.03	Red. threshold	0 V	0 ... 100 V	0x2541:003	general
↳ P706.04	Add.frequency	0.0 Hz	0.0 ... 10.0 Hz	0x2541:004	general
↳ P706.05	Del.overr.time	2.0 s	0.0 ... 60.0 s	0x2541:005	general
P708.xx	Manual control				
↳ P708.01	Keypad setting	CTRL&F/R enable [1]	Selection list	0x2602:001	general
↳ P708.02	Keypad rot.dir.	Forward [0]	Selection list	0x2602:002	general
↳ P708.03	Mode	Keyp.control off [0]	Selection list	0x2602:003	general
P709.xx	KP disp. setup				
↳ P709.01	User MS velocity		Text	0x2865:001	general
↳ P709.02	User PID control		Text	0x2865:002	general
P710.xx	Load loss detect				
↳ P710.01	Threshold	0.0 %	0.0 ... 200.0 %	0x4006:001	general
↳ P710.02	Delay time	0.0 s	0.0 ... 300.0 s	0x4006:002	general
↳ P710.03	Error response	No response [0]	Selection list	0x4006:003	general
P711.xx	Position counter				
↳ P711.01	Signal source	Disabled [0]	Selection list	0x2C49:001	general
↳ P711.02	Reset mode	Rising edge [0]	Selection list	0x2C49:002	general
↳ P711.03	Actual position	-	- (Read only)	0x2C49:003	general
P712.xx	Brake control				
↳ P712.01	Brake mode	Off [2]	Selection list	0x2820:001	general
↳ P712.02	Closing time	100 ms	0 ... 10000 ms	0x2820:002	general
↳ P712.03	Opening time	100 ms	0 ... 10000 ms	0x2820:003	general
↳ P712.07	Closing thresh.	0.2 Hz	0.0 ... 599.0 Hz	0x2820:007	general
↳ P712.08	Holding load	0.0 %	-500.0 ... 500.0 %	0x2820:008	general
↳ P712.12	ClosingThr delay	0 ms	0 ... 10000 ms	0x2820:012	general
↳ P712.13	HoldLoad ramptim	0 ms	0 ... 100 ms	0x2820:013	general
↳ P712.15	Brake status	-	- (Read only)	0x2820:015	general
P718.xx	Flying restart				
↳ P718.01	Current	30 %	0 ... 100 %	0x2BA1:001	MCTRL
↳ P718.02	Start frequency	20.0 Hz	-599.0 ... 599.0 Hz	0x2BA1:002	MCTRL
↳ P718.03	Restart time	5911 ms *	1 ... 60000 ms	0x2BA1:003	MCTRL
↳ P718.08	Fl.res.frequency	x.x Hz	- (Read only)	0x2BA1:008	MCTRL
P721.xx	Mains fail. ctrl				
↳ P721.01	Enable function	Disabled [0]	Selection list	0x2D66:001	general
↳ P721.02	DC-bus act.level	0 % *	60 ... 90 %	0x2D66:002	general
↳ P721.03	Gain V-ctrl	0.01000 Hz/V	0.00001 ... 0.50000 Hz/V	0x2D66:003	general
↳ P721.04	Res. time V-ctrl	20 ms	5 ... 2000 ms	0x2D66:004	general
↳ P721.05	DC voltage setp.	100 %	80 ... 110 %	0x2D66:005	general
↳ P721.06	Setp. ramp	20 ms	1 ... 16000 ms	0x2D66:006	general
↳ P721.07	Clear time	20 ms	1 ... 60000 ms	0x2D66:007	general
↳ P721.08	Restart level	0.0 Hz	0.0 ... 599.0 Hz	0x2D66:008	general
↳ P721.09	RERT:Status	-	- (Read only)	0x2D66:009	general
P730.00	PIN1 protection	0	-1 ... 9999	0x203D	general

* Default setting dependent on the model.

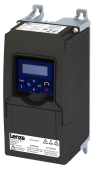

Using accessories

Keypad
Keypad parameterisation mode

Display code	Short designation	Default setting	Setting range	Address	Category
P731.00	PIN2 protection	0	-1 ... 9999	0x203E	general
P732.00	Auto-Save EPM	Inhibit [0]	Selection list	0x2829	general
P740.xx	Favorites sett.				
L P740.01	Parameter 1	0x2DDD0000	0x00000000 ... 0xFFFFFFFF00	0x261C:001	general
L P740.02	Parameter 2	0x60780000	0x00000000 ... 0xFFFFFFFF00	0x261C:002	general
L P740.03	Parameter 3	0x2D890000	0x00000000 ... 0xFFFFFFFF00	0x261C:003	general
L P740.04	Parameter 4	0x603F0000	0x00000000 ... 0xFFFFFFFF00	0x261C:004	general
L P740.05	Parameter 5	0x28240000	0x00000000 ... 0xFFFFFFFF00	0x261C:005	general
L P740.06	Parameter 6	0x28600100	0x00000000 ... 0xFFFFFFFF00	0x261C:006	general
L P740.07	Parameter 7	0x28380100	0x00000000 ... 0xFFFFFFFF00	0x261C:007	general
L P740.08	Parameter 8	0x28380300	0x00000000 ... 0xFFFFFFFF00	0x261C:008	general
L P740.09	Parameter 9	0x25400100	0x00000000 ... 0xFFFFFFFF00	0x261C:009	general
L P740.10	Parameter 10	0x29150000	0x00000000 ... 0xFFFFFFFF00	0x261C:010	general
L P740.11	Parameter 11	0x29160000	0x00000000 ... 0xFFFFFFFF00	0x261C:011	general
L P740.12	Parameter 12	0x29170000	0x00000000 ... 0xFFFFFFFF00	0x261C:012	general
L P740.13	Parameter 13	0x29180000	0x00000000 ... 0xFFFFFFFF00	0x261C:013	general
L P740.14	Parameter 14	0x2C000000	0x00000000 ... 0xFFFFFFFF00	0x261C:014	general
L P740.15	Parameter 15	0x2B000000	0x00000000 ... 0xFFFFFFFF00	0x261C:015	general
L P740.16	Parameter 16	0x2B010100	0x00000000 ... 0xFFFFFFFF00	0x261C:016	general
L P740.17	Parameter 17	0x2B010200	0x00000000 ... 0xFFFFFFFF00	0x261C:017	general
L P740.18	Parameter 18	0x283A0000	0x00000000 ... 0xFFFFFFFF00	0x261C:018	general
L P740.19	Parameter 19	0x29390000	0x00000000 ... 0xFFFFFFFF00	0x261C:019	general
L P740.20	Parameter 20	0x2D430100	0x00000000 ... 0xFFFFFFFF00	0x261C:020	general
L P740.21	Parameter 21	0x2D4B0100	0x00000000 ... 0xFFFFFFFF00	0x261C:021	general
L P740.22	Parameter 22	0x2B120100	0x00000000 ... 0xFFFFFFFF00	0x261C:022	general
L P740.23	Parameter 23	0x60750000	0x00000000 ... 0xFFFFFFFF00	0x261C:023	general
L P740.24	Parameter 24	0x60730000	0x00000000 ... 0xFFFFFFFF00	0x261C:024	general
L P740.25	Parameter 25	0x26310100	0x00000000 ... 0xFFFFFFFF00	0x261C:025	general
L P740.26	Parameter 26	0x26310200	0x00000000 ... 0xFFFFFFFF00	0x261C:026	general
L P740.27	Parameter 27	0x26310300	0x00000000 ... 0xFFFFFFFF00	0x261C:027	general
L P740.28	Parameter 28	0x26310400	0x00000000 ... 0xFFFFFFFF00	0x261C:028	general
L P740.29	Parameter 29	0x26310500	0x00000000 ... 0xFFFFFFFF00	0x261C:029	general
L P740.30	Parameter 30	0x26310600	0x00000000 ... 0xFFFFFFFF00	0x261C:030	general
L P740.31	Parameter 31	0x26310700	0x00000000 ... 0xFFFFFFFF00	0x261C:031	general
L P740.32	Parameter 32	0x26310800	0x00000000 ... 0xFFFFFFFF00	0x261C:032	general
L P740.33	Parameter 33	0x26310900	0x00000000 ... 0xFFFFFFFF00	0x261C:033	general
L P740.34	Parameter 34	0x26310D00	0x00000000 ... 0xFFFFFFFF00	0x261C:034	general
L P740.35	Parameter 35	0x26311200	0x00000000 ... 0xFFFFFFFF00	0x261C:035	general
L P740.36	Parameter 36	0x26311300	0x00000000 ... 0xFFFFFFFF00	0x261C:036	general
L P740.37	Parameter 37	0x26311400	0x00000000 ... 0xFFFFFFFF00	0x261C:037	general
L P740.38	Parameter 38	0x26340100	0x00000000 ... 0xFFFFFFFF00	0x261C:038	general
L P740.39	Parameter 39	0x26340200	0x00000000 ... 0xFFFFFFFF00	0x261C:039	general
L P740.40	Parameter 40	0x26360100	0x00000000 ... 0xFFFFFFFF00	0x261C:040	general
L P740.41	Parameter 41	0x26360200	0x00000000 ... 0xFFFFFFFF00	0x261C:041	general
L P740.42	Parameter 42	0x26360300	0x00000000 ... 0xFFFFFFFF00	0x261C:042	general
L P740.43	Parameter 43	0x26390100	0x00000000 ... 0xFFFFFFFF00	0x261C:043	general
L P740.44	Parameter 44	0x26390200	0x00000000 ... 0xFFFFFFFF00	0x261C:044	general
L P740.45	Parameter 45	0x26390300	0x00000000 ... 0xFFFFFFFF00	0x261C:045	general
L P740.46	Parameter 46	0x26390400	0x00000000 ... 0xFFFFFFFF00	0x261C:046	general
L P740.47	Parameter 47	0x29110100	0x00000000 ... 0xFFFFFFFF00	0x261C:047	general
L P740.48	Parameter 48	0x29110200	0x00000000 ... 0xFFFFFFFF00	0x261C:048	general
L P740.49	Parameter 49	0x29110300	0x00000000 ... 0xFFFFFFFF00	0x261C:049	general
L P740.50	Parameter 50	0x29110400	0x00000000 ... 0xFFFFFFFF00	0x261C:050	general
P750.xx	Param.set setup				
* Default setting dependent on the model.					

Using accessories

Keypad
Keypad parameterisation mode



Display code	Short designation	Default setting	Setting range	Address	Category
L P750.01 ... 32	Parameter 1 ... Parameter 32	0x00000000	0x00000000 ... 0xFFFFFFFF00	0x4041:001 ... 0x4041:032	general
P751.xx	Par. value set 1				
L P751.01 ... 32	Set 1 - Value 1 ... Set 1 - Value 32	0	-2147483648 ... 2147483647	0x4042:001 ... 0x4042:032	general
P752.xx	Par. value set 2				
L P752.01 ... 32	Set 2 - Value 1 ... Set 2 - Value 32	0	-2147483648 ... 2147483647	0x4043:001 ... 0x4043:032	general
P753.xx	Par. value set 3				
L P753.01 ... 32	Set 3 - Value 1 ... Set 3 - Value 32	0	-2147483648 ... 2147483647	0x4044:001 ... 0x4044:032	general
P754.xx	Par. value set 4				
L P754.01 ... 32	Set 4 - Value 1 ... Set 4 - Value 32	0	-2147483648 ... 2147483647	0x4045:001 ... 0x4045:032	general
P755.00	PSet activation	On op. disabled [0]	Selection list	0x4046	general
P756.xx	PSet error msg.				
L P756.01	Status	-	-(Read only)	0x4047:001	general
L P756.02	List entry	-	-(Read only)	0x4047:002	general
P760.xx	Fault config.				
L P760.02	Restart delay	3.0 s	0.0 ... 1000.0 s	0x2839:002	general
L P760.03	Restart counter	5	0 ... 255	0x2839:003	general
L P760.04	Tro.count r.time	40.0 s	0.1 ... 3600.0 s	0x2839:004	general
L P760.05	Trouble counter	-	-(Read only)	0x2839:005	general
L P760.06	FaultStateChange	Reset fault [0]	Selection list	0x2839:006	general
P770.xx	Pump cascading				
L P770.01	Operating mode	Disabled [0]	Selection list	0x405C:001	
L P770.02	Prior.at startup	By oper. time [1]	Selection list	0x405C:002	
L P770.03	Start frequency	40.0 Hz	0.0 ... 599.0 Hz	0x405C:003	
L P770.04	Stop frequency	10.0 Hz	0.0 ... 599.0 Hz	0x405C:004	
L P770.05	Settling time	5.0 s	0.0 ... 3600.0 s	0x405C:005	
L P770.06	Delay time	2.0 s	0.0 ... 3600.0 s	0x405C:006	
L P770.07	Low F threshold	20.0 Hz	0.0 ... 599.0 Hz	0x405C:007	
L P770.08	Up. F threshold	30.0 Hz	0.0 ... 599.0 Hz	0x405C:008	
L P770.09	Auto runtime	0 h	0 ... 1000 h	0x405C:009	
L P770.10	Auto trans.time	0.0 s	-10.0 ... 10.0 s	0x405C:010	
L P770.11	Reset oper.time	Disabled [0]	Selection list	0x405C:011	
L P770.12	Status word	-	-(Read only)	0x405C:012	
L P770.13	Operatingtime p1	x s	-(Read only)	0x405C:013	
L P770.14	Operatingtime p2	x s	-(Read only)	0x405C:014	
P780.00	CiA status word	-	-(Read only)	0x6041	general
P781.00	Set speed	0 rpm	-32768 ... 32767 rpm	0x6042	MCTRL
P782.00	Int. set speed	x rpm	-(Read only)	0x6043	general
P783.00	Actual speed	x rpm	-(Read only)	0x6044	general
P784.xx	Speed limits				
L P784.01	Min. speed	0 rpm	0 ... 480000 rpm	0x6046:001	MCTRL
L P784.02	Max. speed	2147483647 rpm	0 ... 2147483647 rpm	0x6046:002	MCTRL
P785.xx	Accel. ramp				
L P785.01	Delta speed	3000 rpm	0 ... 2147483647 rpm	0x6048:001	MCTRL
L P785.02	Delta time	10 s	0 ... 65535 s	0x6048:002	MCTRL
P786.xx	Decel. ramp				
L P786.01	Delta speed	3000 rpm	0 ... 2147483647 rpm	0x6049:001	MCTRL
L P786.02	Delta time	10 s	0 ... 65535 s	0x6049:002	MCTRL
P788.00	Act. op. mode	-	-(Read only)	0x6061	MCTRL
P789.00	Supported modes	-	-(Read only)	0x6502	general
P790.00	Quick stop dec.	546000 pos. unit/s ²	0 ... 2147483647 pos. unit/s ²	0x6085	MCTRL

* Default setting dependent on the model.

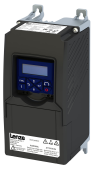

Using accessories

Keypad
Keypad parameterisation mode

Display code	Short designation	Default setting	Setting range	Address	Category
P800.00	Sequencer mode	Disabled [0]	Selection list	0x4025	Sequencer
P801.xx	Segment 1				
L P801.01	Frequency setp.	0.0 Hz	-599.0 ... 599.0 Hz	0x4026:001	Sequencer
L P801.02	Accel./decel.	5.0 s	0.0 ... 3600.0 s	0x4026:002	Sequencer
L P801.03	Time	0.0 s	0.0 ... 100000.0 s	0x4026:003	Sequencer
L P801.04	Digital outp.	0	0 ... 255	0x4026:004	Sequencer
L P801.05	Analog outp.	0.00 VDC	0.00 ... 10.00 VDC	0x4026:005	Sequencer
L P801.06	PID setp.	0.00 PID unit	-300.00 ... 300.00 PID unit	0x4026:006	Sequencer
L P801.07	Torque setp.	100.0 %	-400.0 ... 400.0 %	0x4026:007	Sequencer
P802.xx	Segment 2				
L P802.01	Frequency setp.	0.0 Hz	-599.0 ... 599.0 Hz	0x4027:001	Sequencer
L P802.02	Accel./decel.	5.0 s	0.0 ... 3600.0 s	0x4027:002	Sequencer
L P802.03	Time	0.0 s	0.0 ... 100000.0 s	0x4027:003	Sequencer
L P802.04	Digital outp.	0	0 ... 255	0x4027:004	Sequencer
L P802.05	Analog outp.	0.00 VDC	0.00 ... 10.00 VDC	0x4027:005	Sequencer
L P802.06	PID setp.	0.00 PID unit	-300.00 ... 300.00 PID unit	0x4027:006	Sequencer
L P802.07	Torque setp.	100.0 %	-400.0 ... 400.0 %	0x4027:007	Sequencer
P803.xx	Segment 3				
L P803.01	Frequency setp.	0.0 Hz	-599.0 ... 599.0 Hz	0x4028:001	Sequencer
L P803.02	Accel./decel.	5.0 s	0.0 ... 3600.0 s	0x4028:002	Sequencer
L P803.03	Time	0.0 s	0.0 ... 100000.0 s	0x4028:003	Sequencer
L P803.04	Digital outp.	0	0 ... 255	0x4028:004	Sequencer
L P803.05	Analog outp.	0.00 VDC	0.00 ... 10.00 VDC	0x4028:005	Sequencer
L P803.06	PID setp.	0.00 PID unit	-300.00 ... 300.00 PID unit	0x4028:006	Sequencer
L P803.07	Torque setp.	100.0 %	-400.0 ... 400.0 %	0x4028:007	Sequencer
P804.xx	Segment 4				
L P804.01	Frequency setp.	0.0 Hz	-599.0 ... 599.0 Hz	0x4029:001	Sequencer
L P804.02	Accel./decel.	5.0 s	0.0 ... 3600.0 s	0x4029:002	Sequencer
L P804.03	Time	0.0 s	0.0 ... 100000.0 s	0x4029:003	Sequencer
L P804.04	Digital outp.	0	0 ... 255	0x4029:004	Sequencer
L P804.05	Analog outp.	0.00 VDC	0.00 ... 10.00 VDC	0x4029:005	Sequencer
L P804.06	PID setp.	0.00 PID unit	-300.00 ... 300.00 PID unit	0x4029:006	Sequencer
L P804.07	Torque setp.	100.0 %	-400.0 ... 400.0 %	0x4029:007	Sequencer
P805.xx	Segment 5				
L P805.01	Frequency setp.	0.0 Hz	-599.0 ... 599.0 Hz	0x402A:001	Sequencer
L P805.02	Accel./decel.	5.0 s	0.0 ... 3600.0 s	0x402A:002	Sequencer
L P805.03	Time	0.0 s	0.0 ... 100000.0 s	0x402A:003	Sequencer
L P805.04	Digital outp.	0	0 ... 255	0x402A:004	Sequencer
L P805.05	Analog outp.	0.00 VDC	0.00 ... 10.00 VDC	0x402A:005	Sequencer
L P805.06	PID setp.	0.00 PID unit	-300.00 ... 300.00 PID unit	0x402A:006	Sequencer
L P805.07	Torque setp.	100.0 %	-400.0 ... 400.0 %	0x402A:007	Sequencer
P806.xx	Segment 6				
L P806.01	Frequency setp.	0.0 Hz	-599.0 ... 599.0 Hz	0x402B:001	Sequencer
L P806.02	Accel./decel.	5.0 s	0.0 ... 3600.0 s	0x402B:002	Sequencer
L P806.03	Time	0.0 s	0.0 ... 100000.0 s	0x402B:003	Sequencer
L P806.04	Digital outp.	0	0 ... 255	0x402B:004	Sequencer
L P806.05	Analog outp.	0.00 VDC	0.00 ... 10.00 VDC	0x402B:005	Sequencer
L P806.06	PID setp.	0.00 PID unit	-300.00 ... 300.00 PID unit	0x402B:006	Sequencer
L P806.07	Torque setp.	100.0 %	-400.0 ... 400.0 %	0x402B:007	Sequencer
P807.xx	Segment 7				
L P807.01	Frequency setp.	0.0 Hz	-599.0 ... 599.0 Hz	0x402C:001	Sequencer
L P807.02	Accel./decel.	5.0 s	0.0 ... 3600.0 s	0x402C:002	Sequencer
L P807.03	Time	0.0 s	0.0 ... 100000.0 s	0x402C:003	Sequencer
L P807.04	Digital outp.	0	0 ... 255	0x402C:004	Sequencer

* Default setting dependent on the model.

Using accessories

Keypad
Keypad parameterisation mode



Display code	Short designation	Default setting	Setting range	Address	Category
L P807.05	Analog outp.	0.00 VDC	0.00 ... 10.00 VDC	0x402C:005	Sequencer
L P807.06	PID setp.	0.00 PID unit	-300.00 ... 300.00 PID unit	0x402C:006	Sequencer
L P807.07	Torque setp.	100.0 %	-400.0 ... 400.0 %	0x402C:007	Sequencer
P808.xx	Segment 8				
L P808.01	Frequency setp.	0.0 Hz	-599.0 ... 599.0 Hz	0x402D:001	Sequencer
L P808.02	Accel./decel.	5.0 s	0.0 ... 3600.0 s	0x402D:002	Sequencer
L P808.03	Time	0.0 s	0.0 ... 100000.0 s	0x402D:003	Sequencer
L P808.04	Digital outp.	0	0 ... 255	0x402D:004	Sequencer
L P808.05	Analog outp.	0.00 VDC	0.00 ... 10.00 VDC	0x402D:005	Sequencer
L P808.06	PID setp.	0.00 PID unit	-300.00 ... 300.00 PID unit	0x402D:006	Sequencer
L P808.07	Torque setp.	100.0 %	-400.0 ... 400.0 %	0x402D:007	Sequencer
P820.00	StartOfSeq. mode	Restart sequencr [0]	Selection list	0x4040	Sequencer
P822.xx	End segment				
L P822.01	Frequency setp.	0.0 Hz	-599.0 ... 599.0 Hz	0x402E:001	Sequencer
L P822.02	Accel./decel.	5.0 s	0.0 ... 3600.0 s	0x402E:002	Sequencer
L P822.03	Time	0.0 s	0.0 ... 100000.0 s	0x402E:003	Sequencer
L P822.04	Digital outp.	0	0 ... 255	0x402E:004	Sequencer
L P822.05	Analog outp.	0.00 VDC	0.00 ... 10.00 VDC	0x402E:005	Sequencer
L P822.06	PID setp.	0.00 PID unit	-300.00 ... 300.00 PID unit	0x402E:006	Sequencer
L P822.07	Torque setp.	100.0 %	-400.0 ... 400.0 %	0x402E:007	Sequencer
P824.00	End of seq. mode	Keep running [0]	Selection list	0x402F	Sequencer
P830.xx	Sequence 1				
L P830.01 ... 16	Step 1 ... Step 16	Skip step [0]	Selection list	0x4030:001 ... 0x4030:016	Sequencer
P831.00	Cycl. sequence 1	1	1 ... 65535	0x4031	Sequencer
P835.xx	Sequence 2				
L P835.01 ... 16	Step 1 ... Step 16	Skip step [0]	Selection list	0x4032:001 ... 0x4032:016	Sequencer
P836.00	Cycl. sequence 2	1	1 ... 65535	0x4033	Sequencer
P840.xx	Sequence 3				
L P840.01 ... 16	Step 1 ... Step 16	Skip step [0]	Selection list	0x4034:001 ... 0x4034:016	Sequencer
P841.00	Cycl. sequence 3	1	1 ... 65535	0x4035	Sequencer
P845.xx	Sequence 4				
L P845.01 ... 16	Step 1 ... Step 16	Skip step [0]	Selection list	0x4036:001 ... 0x4036:016	Sequencer
P846.00	Cycl. sequence 4	1	1 ... 65535	0x4037	Sequencer
P850.xx	Sequence 5				
L P850.01 ... 16	Step 1 ... Step 16	Skip step [0]	Selection list	0x4038:001 ... 0x4038:016	Sequencer
P851.00	Cycl. sequence 5	1	1 ... 65535	0x4039	Sequencer
P855.xx	Sequence 6				
L P855.01 ... 16	Step 1 ... Step 16	Skip step [0]	Selection list	0x403A:001 ... 0x403A:016	Sequencer
P856.00	Cycl. sequence 6	1	1 ... 65535	0x403B	Sequencer
P860.xx	Sequence 7				
L P860.01 ... 16	Step 1 ... Step 16	Skip step [0]	Selection list	0x403C:001 ... 0x403C:016	Sequencer
P861.00	Cycl. sequence 7	1	1 ... 65535	0x403D	Sequencer
P865.xx	Sequence 8				
L P865.01 ... 16	Step 1 ... Step 16	Skip step [0]	Selection list	0x403E:001 ... 0x403E:016	Sequencer
P866.00	Cycl. sequence 8	1	1 ... 65535	0x403F	Sequencer

* Default setting dependent on the model.



15.1.3 Keypad settings

For the keypad various settings can be made, which are described in detail in the following subchapters.

15.1.3.1 Select language

Parameter

Address	Name / setting range / [default setting]	Information
0x2863 (P705.00)	Keypad language selection (KP language)	Language selection for the keypad display.
	0 No language selected	
	1 English	
	2 German	

15.1.3.2 Change setpoint increment

Parameter

Address	Name / setting range / [default setting]	Information
0x2862 (P701.00)	Keypad setpoint increment (KP setp. incr.) 1 ... [1] ... 100	<p>Adaptation of the increment for keypad setpoints when a keypad arrow key is pressed once. The value set serves as a multiplier for the preset increments.</p> <p>Setting 1 corresponds to the following increments:</p> <ul style="list-style-type: none"> • 0.1 Hz for frequency setpoint 0x2601:001 (P202.01). • 0.01 PUnit for process controller setpoint 0x2601:002 (P202.02). • 0.1 % for torque setpoint 0x2601:003 (P202.03). <p>Notes:</p> <ul style="list-style-type: none"> • With a setting > 1, the option of repeatedly changing the setpoint by pressing the key for a longer time is deactivated. • The setting only has an impact on the keypad setpoints. <p>Example: with the setting "5", the keypad frequency setpoint is increased/decreased by 0.5 Hz every time the key is pressed.</p>

15.1.3.3 Configure status display

During operation, the keypad displays the output frequency of the inverter, or with an active PID control it shows the process controller setpoint. Alternatively, an optional diagnostic parameter can be displayed during operation.

Parameter

Address	Name / setting range / [default setting]	Information
0x2864 (P703.00)	Keypad status display (KP status displ.) 0x00000000 ... [0x00000000] ... 0xFFFFFFFF	<p>0 = normal display depending on the operating mode</p> <ul style="list-style-type: none"> • In case of an active frequency control, the keypad displays the output frequency of the inverter. • In case of active PID control, the keypad displays the current Process controller setpoint in [P-Unit]. <p>As an alternative, an optional diagnostic parameter can be set here, which is to be shown on the keypad during operation.</p> <ul style="list-style-type: none"> • Format: 0xiiiiSS00 (iiii = hexadecimal index, SS = hexadecimal subindex) • The lowest byte is always 0x00. • The keypad can be used to select the desired diagnostics parameter from a list.
0x2865:001 (P709.01)	Keypad display setup: User unit MS velocity mode (KP disp. setup: User MS velocity)	<p>Optional setting of an individual unit for the keypad operation display of the output frequency.</p> <ul style="list-style-type: none"> • Setting is only possible with »EASY Starter«. • Maximum text length = 6 ASCII characters.
0x2865:002 (P709.02)	Keypad display setup: User unit PID control (KP disp. setup: User PID control)	<p>Optional setting of an individual unit for the keypad operation display of the current process controller setpoint.</p> <ul style="list-style-type: none"> • Setting is only possible with »EASY Starter«. • Maximum text length = 6 ASCII characters.
0x4002 (P702.00)	Speed display scaling (ScaI.speed fact.) 0.00 ... [0.00] ... 650.00	<p>Factor for the scaling of the speed display in 0x400D (P101.00).</p> <ul style="list-style-type: none"> • With the setting "0.00", no scaling takes place. • Example: with the "16.50" and the actual frequency = 50 Hz, 0x400D (P101.00) shows the speed "825 units".

Using accessories



Keypad
Keypad settings





15.1.3.4 Configure R/F and CTRL keys

Keypad rotation setup

Use the  keypad to reverse the rotation direction at local keypad control.

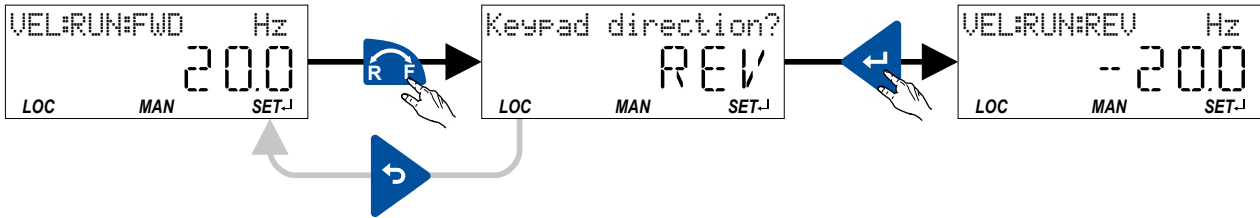
- After the  key has been pressed, the reversal of rotation direction must be confirmed with the  key. (The  key serves to cancel the action.)



The keypad key 

- directly changes the keypad rotation setup in [0x2602:002 \(P708.02\)](#).
- has no function in case of a bipolar setpoint selection (e. g. ± 10 V). In this case, the direction of rotation is determined by the sign of the setpoint.
- has no function if the rotation limitation "Only clockwise (CW) [0]" is set in [0x283A \(P304.00\)](#).
- has no function in the operating mode [0x6060 \(P301.00\)](#) = "MS: Torque mode [-1]".
- has no function if the PID control is activated.
- can be deactivated in [0x2602:001 \(P708.01\)](#).

Keypad Full Control

The "Keypad Full Control" control mode can be activated with the keypad key "CTRL". Both the control and the setpoint selection are then made via the keypad. This special control mode can be, for instance, used during the commissioning phase if external control and setpoint sources are not ready to use yet.

For details see chapter "Overview of the control options: [Keypad full control](#)". [53](#)

The keypad key CTRL

- directly changes the setting in [0x2602:003 \(P708.03\)](#).
- can be deactivated in [0x2602:001 \(P708.01\)](#).

Parameter

Address	Name / setting range / [default setting]	Information
0x2602:001 (P708.01)	Manual control: Keypad setting (Manual control: Keypad setting)	Disable/enable CTRL and F/R key of the keypad.
	• From version 03.00	
	0 CTRL & F/R disable	
	1 CTRL & F/R enable	
	2 CTRL enable F/R disable	
3 CTRL disable F/R enable		
0x2602:002 (P708.02)	Manual control: Keypad rotational direction (Manual control: Keypad rot.dir.)	Instructed direction of rotation if local keypad control is active.
	• From version 03.00	
	0 Forward	
1 Reverse	<ul style="list-style-type: none"> • If the local keypad control is active, this setting can be directly changed via the keypad key  if the key in 0x2602:001 (P708.01) has not been disabled. • When the remote control is changed over to local keypad control and vice versa, this parameter is set to "Forward [0]". 	



Using accessories

Keypad
Keypad settings

Address	Name / setting range / [default setting]	Information
0x2602:003 (P708.03)	Manual control: Mode (Manual control: Mode) • From version 03.00	Activate/deactivate full keypad control. • This setting can be changed directly via the keypad key CTRL if the key in 0x2602:001 (P708.01) has not been disabled.
	0 Keypad full control off	• When the control mode is changed over, the motor is stopped and the "Forward" direction of rotation is set.
	1 Keypad full control on	
	2 Manual mode	<ul style="list-style-type: none"> • Access via engineering tools only. • The active control is removed from the current control source / setpoint source. • Start and stop command as well as the setpoint are controlled via a special dialog. • A connection control is active (engineering tool <-> inverter) • The operator is responsible for the safety and impact of this function.

Using accessories

WLAN module
WLAN LED status displays



15.2 WLAN module

The pluggable WLAN module enables

- an easy access to inverters that are installed in difficult access areas,
- an easy parameter setting without cable and instead of the keypad,
- a comfortable monitoring and adaptation of the machine.

The inverter can be accessed via WLAN with the following devices:

- Engineering PC (with WLAN functionality) and the »EASY Starter« engineering tool.
- Android smartphone with Lenze Smart Keypad App.

The Lenze Smart Keypad App is recommended for the adaptation of simple applications. The Lenze Smart Keypad App can be found in the Google Play Store and in the Apple App Store.

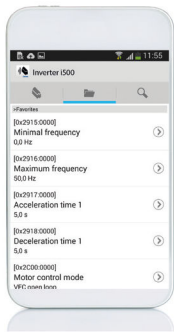

Android



iOS



Default settings: Access-Point mode, WLAN-SSID = "i5", WLAN password = "password"

If the WLAN module is to be plugged onto the inverter for a longer period of time, it is important to select a safe password in 0x2441:008. Otherwise, a potential attacker might connect to the WLAN access point and attack the device and other connected devices or networks.

15.2.1 WLAN LED status displays

Information on the WLAN module status can be obtained quickly via the LED displays "Power", "TX/RX" and "WLAN" on the front of the WLAN module.

The meaning can be seen from the table below.

LED "Power" (green)	LED "TX/RX" (yellow)	LED "WLAN" (green)	Status/meaning
off	off	off	No supply voltage.
on	on	on	Self-test (duration approx. 1 s)
on	off	off	Ready for operation — no active WLAN connection.
on	Flashing	on	Communication active.
on	off	blinking	Client mode — waiting for connection.
blinking	off	off	Trouble



After being plugged in, the WLAN module needs approx. 20 seconds until it is ready for operation.



15.2.2 WLAN basic settings

The WLAN functionality can be configured via the following parameters.

Preconditions

WLAN module has been plugged onto the interface X16 on the front of the inverter.

Details

- The WLAN module can be connected and removed during operation.
- The WLAN module can either create an own WLAN network (access point mode, default setting) or implement itself as a WLAN client in an already existing WLAN network. For details see the following subchapters.
- The WLAN connection is encrypted. The WLAN encryption can be selected in [0x2441:009](#).
- [0x2441:012](#) can be used to set the name of the WLAN network, called SSID, so that it is not visible for other WLAN devices. As a result, the number of WLAN networks displayed on smartphone or PC can be reduced.
- Two data sources are possible for the WLAN settings: Inverter and WLAN module.
 - Data source - inverter: The WLAN settings saved in the inverter are used. Each inverter has its own WLAN settings.
 - Data source - WLAN module: The WLAN settings saved in the WLAN module are used. In this "stand-alone" mode, the WLAN module can be plugged onto another inverter and then be used with the same settings (irrespective of the WLAN settings of the inverter).
- The data source is activated with [0x2440](#).
- The currently active data source is displayed in [0x2442:004](#).

Parameter

Address	Name / setting range / [default setting]	Information
0x2440	Initiate WLAN • From version 02.00	Restart WLAN network with default setting or current settings.
	0 No action/no error	Only status display.
	1 Restart with current values (from version 04.00)	Restart WLAN network with current settings of the WLAN parameters. • The WLAN settings of the active data source (inverter or WLAN module) are used. • The active data source is displayed in 0x2442:004 . • The data source is not changed by this selection. Note! This selection is currently not supported by the WLAN module V1.0.
	2 Restart with default values	Restart WLAN network with default setting of the WLAN parameters. • The WLAN settings saved in the WLAN module are deleted. • Active data source for the WLAN settings is now the inverter.
	11 Save settings in WLAN module	Restart WLAN network with current settings of the WLAN parameters. • The current settings are saved in the WLAN module. • Active data source for the WLAN settings is now the WLAN module.
0x2441:004	WLAN settings: DHCP • From version 02.00	1 = Dynamic Host Configuration Protocol (DHCP) is enabled. • In the access point mode, the DHCP server of the WLAN module is activated. • In the client mode, the DHCP-client function is activated.
	0 Disabled	
	1 Enabled	
0x2441:005	WLAN settings: DHCP start address 0.0.0.0 ... [0.0.0.0] ... 255.255.255.255 • From version 02.00	Definition of the start address when the Dynamic Host Configuration Protocol (DHCP) is used. • Only relevant for access point mode. • When 0 is set, the active IP address + 1 is used as start address.
0x2441:006	WLAN settings: WLAN operation mode • From version 02.00	Definition of the operating mode of the WLAN module.
	0 Access point mode	For a direct connection to another WLAN device, the WLAN module creates an own WLAN network. ▶ WLAN access point mode 432
	1 Client mode	The WLAN module can be integrated as WLAN client into an already existing WLAN network. ▶ WLAN client mode 437

Using accessories

WLAN module
WLAN basic settings



Address	Name / setting range / [default setting]	Information
0x2441:007	WLAN settings: WLAN SSID ["i5"] • From version 02.00	Name (Service Set Identifier, SSID) of the WLAN network. • The preset name consists of the device name (iXXX) and the last 10 digits of the serial number of the Control Unit. • Example: "i550_0123456789" • The serial number is displayed in 0x2000:002 (P190.02) .
0x2441:008	WLAN settings: WLAN password ["password"] • From version 02.00	Password (WLAN network key) of the WLAN network. • This password serves to secure the WLAN connections. • The password must have a minimum length of 8 characters. Although shorter passwords are accepted and saved, the WLAN module cannot be operated with such a password. • The character "*" is not allowed. Note! If the WLAN module is to be plugged onto the inverter for a longer period of time, it is important to select a safe password. Otherwise, a potential attacker might connect to the WLAN access point and attack the device and other connected devices or networks. Currently (status: 2016), a WLAN is considered as safe if the password • consists of more than 20 characters, • contains capital and small letters, numbers and special characters and • cannot be found in any dictionary.
0x2441:009	WLAN settings: WLAN security • From version 02.00	Selection of the WLAN encryption.
	0 WPA	
	1 WPA2	
0x2441:010	WLAN settings: WLAN access • From version 02.00	Switch on/off WLAN.
	0 Disabled (WLAN off)	
	1 Enabled (WLAN on)	
0x2441:011	WLAN settings: WLAN channel • From version 02.00	Selection of the WLAN channel.
	1 Channel 1	
	2 Channel 2	
	3 Channel 3	
	4 Channel 4	
	5 Channel 5	
	6 Channel 6	
	7 Channel 7	
	8 Channel 8	
	9 Channel 9	
	10 Channel 10	
	11 Channel 11	
0x2441:012	WLAN settings: WLAN SSID broadcast • From version 02.00	1 = the name of the WLAN network, called SSID, is not visible for other WLAN devices.
	0 Activated	
	1 Deactivated	
0x2442:004	Active WLAN settings: Active module mode • Read only • From version 02.00	Display of the active data source for the WLAN settings. • This parameter indicates whether the settings used come from the inverter or from the WLAN module.
	0 Inverter	The WLAN settings saved in the inverter are used.
	1 Standalone	The WLAN settings saved in the WLAN module are used.
0x2442:005	Active WLAN settings: MAC address • Read only • From version 02.00	Display of the MAC address of the WLAN module.



15.2.2.1 Resetting WLAN settings to default setting

Possible reasons:

- Password is not known anymore.
- WLAN SSID is not visible and not known anymore.
- WLAN module mode "stand-alone" shall be deactivated.

0x2440 serves to reset all WLAN settings to the default setting. For this purpose, the inverter must be connected to the »EASY Starter« via the USB module or an existing network.

Option 1: Reset via USB module

How to reset the WLAN settings to default setting by means of the USB module:

Requirements:

- The inverter is ready for operation (supplied with voltage).

Required accessories:

- USB module
- USB 2.0 cable (A-plug on micro B-plug)
- PC with installed »EASY Starter« software

1. Remove the WLAN module from the inverter and plug in the USB module instead.
2. Establish a connection between inverter and »EASY Starter« via the USB module.
3. Set the parameter **0x2440** to "Restart with default values [2]".
4. Remove the USB module from the inverter and plug in the WLAN module instead again.

The default setting is loaded.

Option 2: Reset via network

How to reset the WLAN settings to default setting via network:

Requirements:

- The inverter is ready for operation (supplied with voltage).
- The inverter is connected to a functioning network.

Required accessories:

- PC with installed »EASY Starter«. In addition, the PC must be connected to the network which also implements the inverter.

1. Establish a connection between the inverter and »EASY Starter« via the used network.
2. Set the parameter **0x2440** to "Restart with default values [2]".

The default setting is loaded.

Using accessories

WLAN module
WLAN access point mode



15.2.3 WLAN access point mode

By default, the WLAN module is configured as a WLAN access point because this is the most frequent application. In this operating mode, the WLAN module creates its own WLAN network for a direct connection to other WLAN devices.

The supported WLAN devices are:

- Android smartphone with Lenze Smart Keypad App.
- Engineering PC (with WLAN functionality) and the »EASY Starter« engineering tool.

Details

- By default, every inverter with WLAN functionality comes with an individual network name, called "SSID".
- The preset network name consists of the device name (iXXX) and the first 10 digits of the serial number (example: "i550_0123456789").
- By default, the password for the WLAN network is "password" and can be changed in 0x2441:008.



If the WLAN module is to be plugged onto the inverter for a longer period of time, it is important to select a safe password. Otherwise, a potential attacker might connect to the WLAN access point and attack the device and other connected devices or networks. Currently (status: 2016), a WLAN is considered as safe if the password consists of more than 20 characters, contains capital and small letters, numbers and special characters and cannot be found in any dictionary.

The following illustration displays the SSIDs as examples only:

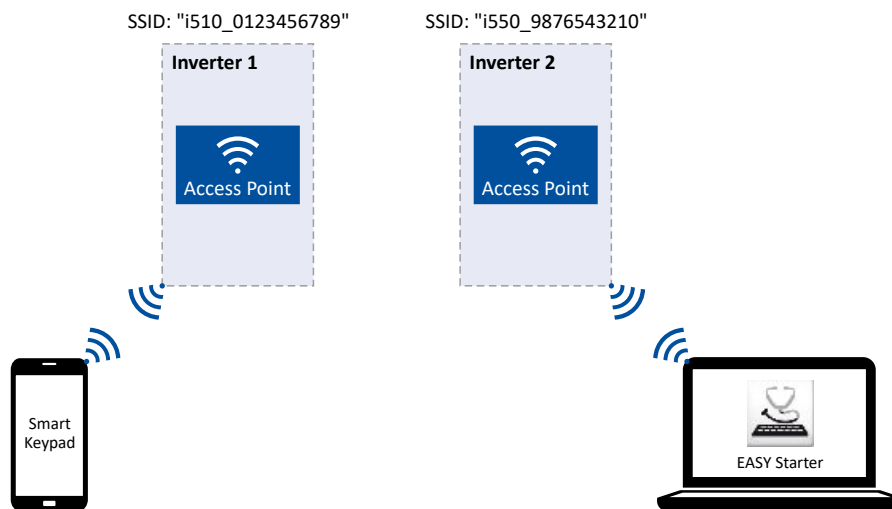

For establishing a WLAN connection, only a few settings are required. The respective setting is described in the following subchapters:

- [Establish a WLAN connection between smartphone and inverter](#) 433
- [Using the smartphone as "Smart Keypad"](#) 434
- [Establish a WLAN connection between Engineering PC and inverter](#) 435



15.2.3.1 Establish a WLAN connection between smartphone and inverter

How to establish a direct WLAN connection to the inverter on the smartphone:

Requirements:

- The functional test described in the mounting and switch-on instructions has been completed successfully (without any errors or faults).
- The inverter is ready for operation (supplied with voltage).

Required accessories:

- WLAN module
- Android smartphone
- Lenze Smart Keypad App (available free of charge in the Google Play Store)

1. Plug the WLAN module onto the front of the inverter (interface X16).
2. Unless already activated, activate the WLAN function on the smartphone under "Settings" → "WLAN".

The WLAN networks available in your range are now displayed.

3. Select the WLAN network established by the inverter.
4. Enter the password for the WLAN network (default setting "password") and click "Connect".

The connection to the WLAN network of the inverter is now established.

5. Start the Lenze Smart Keypad App on the Android smartphone.

If a WLAN connection to the inverter has been established, the Lenze Smart Keypad App serves to

- read out diagnostics parameters of the inverter,
- change parameter settings of the inverter and
- transmit parameter sets.

Using accessories

WLAN module
WLAN access point mode



15.2.3.2 Using the smartphone as "Smart Keypad"

In the default setting, the WLAN settings of the inverters are used. If the WLAN module is plugged onto another inverter, the WLAN connection must be set up again because the replugging causes a change of the network name.

For using the smartphone as "Smart Keypad", the WLAN module can be configured such that the WLAN settings are saved locally in the WLAN module and only these settings are used. In this "standalone" mode, the WLAN module remains permanently coupled to the smartphone because after replugging onto another inverter, the login data for the WLAN network (SSID and password) is the same:

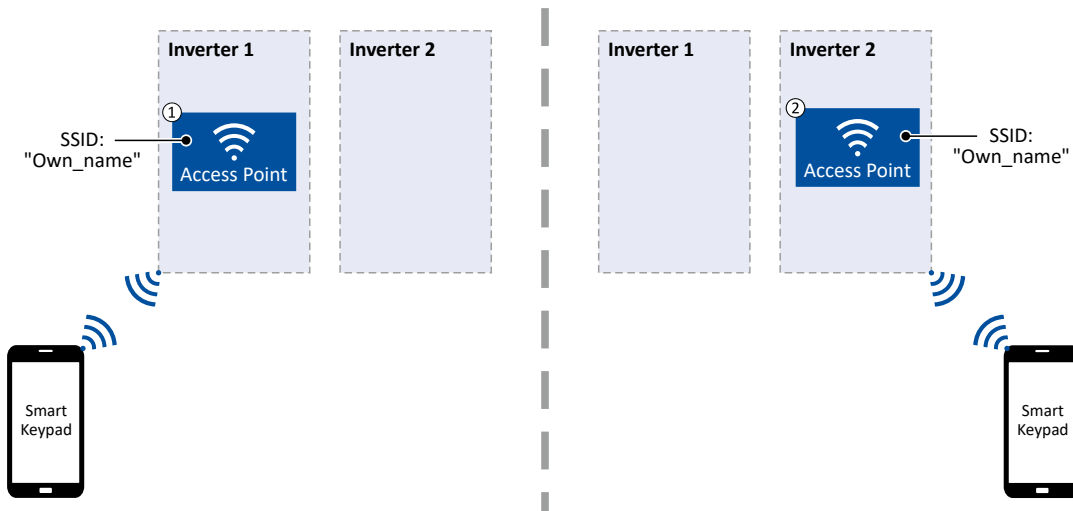

- ① WLAN module is plugged onto the inverter 1. After the connection to the smartphone has been established, the inverter 1 can be diagnosed or parameterised with the Lenze Smart Keypad App.
- ② WLAN module is plugged onto the inverter 2. After the WLAN network is restarted, a connection is established again to the smartphone because the WLAN settings are identical. Now, the inverter 2 can be diagnosed or parameterised with the Lenze Smart Keypad App.

How to configure the WLAN module for a "Smart Keypad" use:

Requirements:

- The WLAN settings of the inverter can be accessed via the Lenze Smart Keypad App or »EASY Starter«.

1. Define your own network name (SSID) in [0x2441:007](#).
2. Define your own password in [0x2441:008](#).
3. Set the selection "Save settings in WLAN module [11]" in [0x2440](#).

The defined network name and the password are saved locally in the WLAN module. The WLAN network is restarted with the current settings.

If the WLAN module is then plugged onto another inverter, the settings that are locally saved in the WLAN module are used (irrespective of the WLAN settings of the inverter).

- The active mode ("Inverter" or "Standalone") is displayed in [0x2442:004](#).
- In order to return to the standard mode "Inverter", the selection "Restart with default values [2]" must be set in [0x2440](#).



15.2.3.3 Establish a WLAN connection between Engineering PC and inverter

How to establish a direct WLAN connection to the inverter on the Engineering PC:

Requirements:

- The functional test described in the mounting and switch-on instructions has been completed successfully (without any errors or faults).
- The inverter is ready for operation (supplied with voltage).

Required accessories:

- WLAN module
- PC (with WLAN functionality) and installed »EASY Starter«

1. Plug the WLAN module onto the front of the inverter (interface X16).
2. Open the network settings on the Engineering PC: "Control panel" → "Network and sharing center".
3. Select the "Set up a new connection or network" option under "Change your network settings".

The "Set Up a Connection or Network" dialog box is displayed.

4. Select the "Manually connect to a wireless network" connection option and click the "Next" button.

The "Manually connect to a wireless network" dialog box is displayed.

5. Enter the SSID of the inverter as network name.
6. Select "WPA2-Personal" as safety type.
7. Select "AES" as encryption type.
8. Enter the password as safety key for the WLAN network (default setting "password").
9. Tick "Start this connection automatically".
10. Click "Next".

A note indicates that the connection has been added successfully.

11. Click "Close".
12. Start »EASY Starter«.

The "Add devices" dialog is shown.

13. Select connection "WLAN - WLAN with module i5MADU0000000S":

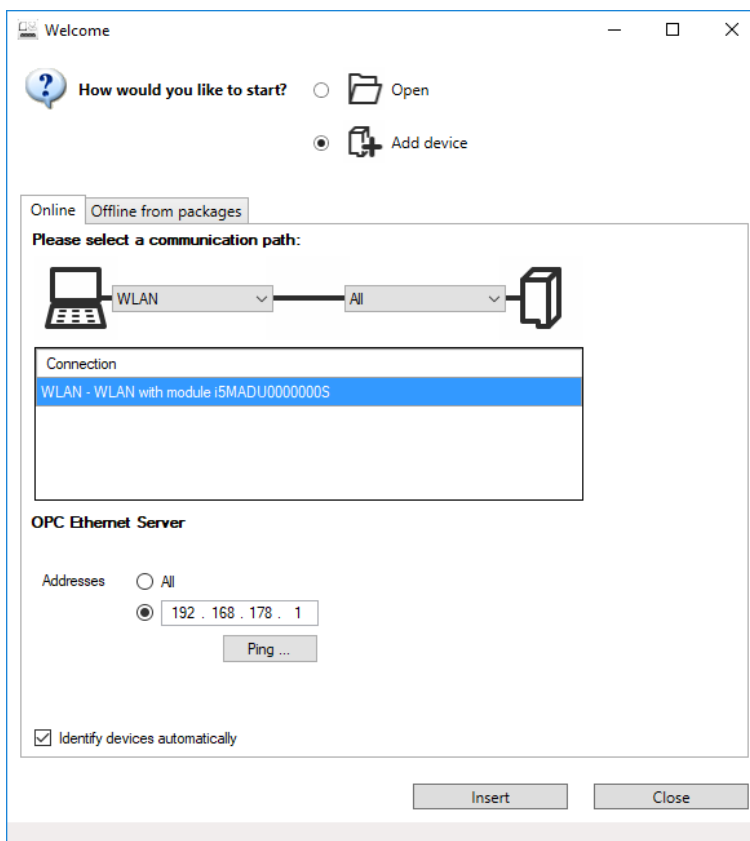

Using accessories

WLAN module
WLAN access point mode

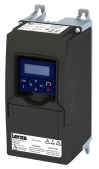



14. Set the address to the WLAN IP address of the drive. The default IP address of the WLAN module is: 192.168.178.1. The active WLAN address is in [0x2442:001](#).

15. Click the **Insert** button.

»EASY Starter« searches for connected devices via the communication path selected.

When the connection has been established successfully, the inverter is displayed in the device list of »EASY Starter«. The inverter parameters can now be accessed via the tabs of »EASY Starter«.

Recommendation: Click the button in the toolbar of the »EASY Starter«  to start visual tracking. This function serves to quickly check whether the connection to the correct device has been established. [▶ Optical device identification](#)  345



15.2.4 WLAN client mode

The WLAN module can be optionally configured as a WLAN client. In this operating mode, the WLAN module can be implemented into an already existing WLAN network.

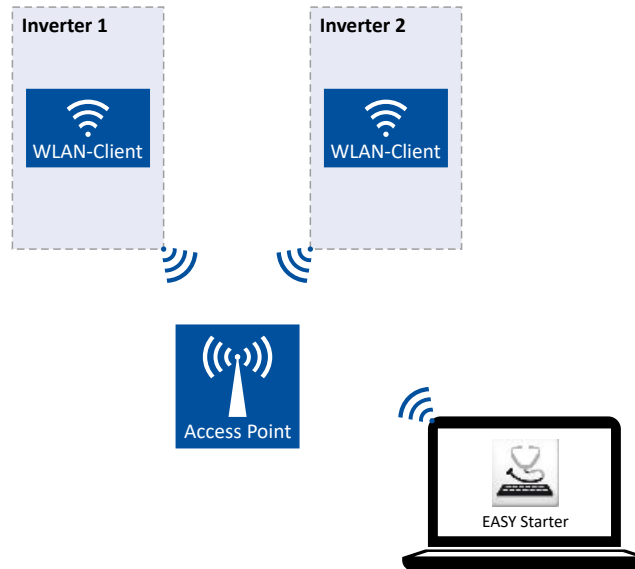

How to configure the WLAN module as WLAN client:

Requirements:

- The WLAN settings of the inverter can be accessed via »EASY Starter«.
- Name (SSID) and password of the external WLAN network are known.

1. Set the selection "Client mode [1]" in [0x2441:006](#).
2. Set the name (SSID) of the external WLAN network in [0x2441:007](#).
3. Set the password of the external WLAN network in [0x2441:008](#).
4. [Saving the parameter settings.](#) [35](#)



Before activating the changed WLAN settings in the next step: Make sure that the name (SSID) and the password of the external WLAN network are set correctly. The restart of the WLAN module in the client mode causes a termination of an existing WLAN connection in the access point mode!

5. Restart the inverter or remove and replug the WLAN module to activate the changed WLAN settings.

The WLAN module now tries as a client to establish a connection to the set external WLAN network.

Notes:

- In the default setting, the WLAN client is configured as DHCP client in [0x2441:004](#).
 - Settings as IP address, subnetwork mask and gateway are automatically made by the DHCP server of the external WLAN network.
 - The active settings are displayed in [0x2442:001](#), [0x2442:002](#) and [0x2442:003](#).
- A static IP configuration can be made via the parameters [0x2441:001](#), [0x2441:002](#) and [0x2441:003](#).

Parameter

Address	Name / setting range / [default setting]	Information
0x2441:001	WLAN settings: IP address 0.0.0.0 ... [192.168.178.1] ... 255.255.255.255 • From version 02.00	Definition of the IP address for the WLAN access point. <ul style="list-style-type: none"> • In the client mode, a static IP address can be set here for the WLAN client. In order that the static configuration becomes effective, DHCP must be disabled in 0x2441:004. • Byte order is "Big-Endian": 192.168.178.01 = 0x01B2A8C0 (= 28485824)

Using accessories

WLAN module
WLAN diagnostics



Address	Name / setting range / [default setting]	Information
0x2441:002	WLAN settings: Netmask 0.0.0.0 ... [255.255.255.0] ... 255.255.255.255 • From version 02.00	Definition of the network mask for the WLAN access point. • In the client mode, a static network mask can be set here for the WLAN client. In order that the static configuration becomes effective, DHCP must be disabled in 0x2441:004. • Byte order is "Big-Endian": 255.255.255.0 = 0x00FFFFFF (= 16777215)
0x2441:003	WLAN settings: Gateway 0.0.0.0 ... [192.168.178.1] ... 255.255.255.255 • From version 02.00	Definition of the gateway for the WLAN access point. • In the client mode, a static gateway can be set here for the WLAN client. In order that the static configuration becomes effective, DHCP must be disabled in 0x2441:004. • Byte order is "Big-Endian": 192.168.178.1 = 0x01B2A8C0 (= 28485824)
0x2442:001	Active WLAN settings: Active IP address • Read only • From version 02.00	Display of the active IP address. • If DHCP is activated, the active IP address usually derives from the configured static IP address of the device.
0x2442:002	Active WLAN settings: Active netmask • Read only • From version 02.00	Display of the active netmask.
0x2442:003	Active WLAN settings: Active gateway • Read only • From version 02.00	Display of the active gateway IP address.

15.2.5 WLAN diagnostics

The following parameters serve to diagnose the WLAN module and the WLAN communication.

Preconditions

WLAN module has been plugged onto the interface X16 on the front of the inverter.

Parameter

Address	Name / setting range / [default setting]	Information
0x2448:001	WLAN status: Connection time • Read only • From version 02.00	Display of the connection time in [s] since the current connection was established.
0x2448:002	WLAN status: Number of connections • Read only • From version 02.00	In access point mode: Display of the number of currently connected clients. In client mode: 0 = not connected; 1 = connected with external WLAN network.
0x2448:003	WLAN status: Rx frame counter • Read only • From version 02.00	Display of the number of request received via WLAN.
0x2448:004	WLAN status: Error statistics • Read only • From version 02.00	Display of the quality of the WLAN connection. A display value > 0 indicates communication problems.
0x2449	WLAN error • Read only • From version 02.00	Bit coded display of WLAN errors.
	Bit 2 WLAN error	
	Bit 3 Memory problem	
	Bit 4 WLAN connection problem	
	Bit 7 WLAN off	
	Bit 9 Client mode off	
	Bit 12 TCP/IP configuration error	
	Bit 13 Password length	
	Bit 14 Access denied	



16 Diagnostics and fault elimination

This section contains information on error handling, drive diagnostics and fault analysis.

16.1 LED status display

The "RDY" and "ERR" LED status displays on the front of the inverter provide some quick information about certain operating states.

"RDY" LED (blue)	"ERR" LED (red)	Status/meaning
Off	Off	Supply voltage not available.
On	On	Initialisation in progress (inverter is being started.)
Blinks (1 Hz)	Off	Safe torque off (STO) active. The inverter has been inhibited by the integrated safety system.
Blinks (1 Hz)	On	Inverter inhibited, error active. ▶ Error handling 455
On	Off	Inverter enabled. Motor rotates according to the specified setpoint or quick stop is active.
Both LEDs are blinking in a rapidly alternating mode		Firmware update active. ▶ Update device firmware 363
Both LEDs are blinking in a very rapidly synchronous mode		"Visual tracking" function is active. ▶ Optical device identification 345

16.2 Logbook

With the logbook, the controller has access to the last 32 messages of the inverter.

- The logbook is saved persistently in the inverter.
- The logbook has a ring buffer structure:
 - As long as free memory is available in the logbook, a message is entered following the next free memory unit.
 - When all memory units are occupied, the oldest message is deleted for a new message.
 - Always the most recent messages remain available.
- On the basis of the "Diag code" (32-bit word) of each individual message it can be seen which axis the message refers to.

Parameter

Address	Name / setting range / [default setting]	Information
0x2022:015 (P700.15)	Device commands: Delete logbook (Device commands: Delete logbook)	<ul style="list-style-type: none"> • When the device command has been executed successfully, the value 0 is shown. • Do not switch off the supply voltage during the deletion process and do not unplug the memory module!
	0 Off / ready	Only status feedback
	1 On / start	



16.3 Error history buffer

For purposes of diagnostics, the error history buffer contains the last 32 error and warning messages of the inverter, which have occurred during operation. The error history buffer can be read out using the keypad via P155.00 and provides a limited view on the logbook.

Details

- For each event that is recorded, the error history buffer contains the message text, the error code, the time of occurrence as well as a counter for successive, identical events. If an event that has already been recorded occurs repeatedly, only the counter is incremented.
- The error history buffer can be reset by the user. In order to prevent the buffer from being reset by the user, this function can be protected by means of a password.
- Observe that the error history buffer only presents a snapshot at the time the data are read out. If a new event occurs, the error history buffer must be read out again via P155.00 so that the new event becomes visible.

Accessing the error history buffer with the keypad

1. Use the **↩** key in the operating mode to navigate to the parameterisation mode one level below.
You are now in the group level. All parameters of the inverter are divided into different groups according to their function.
Note: By using the **↩** key you can navigate one level upwards again anytime.
2. Use the **↑** navigation key to select group 1 ("Diagnostics").
3. Use the **↩** key to navigate to one level below.
You are now in the parameter level of the group selected.
4. Use the **↑** and **↓** select the P155.00 parameter.
5. Use the **↩** key to navigate to one level below.
You are now in the error history buffer.
6. Use the **↑** and **↓** navigation keys you can now scroll through the error history buffer entries.
Use the **↩** key, you can switch over the display.

Information displayed (page 1):

- ① Message text
- ② No. of the entry (01 = latest event)
- ③ Response (W = warning, T = trouble, F = fault)
- ④ Error code

Information displayed (page 2):

- ⑤ Time of occurrence
- ⑥ No. of the entry (01 = latest event)
- ⑦ Counter for successive, identical events

Note: By using the **↩** key you can exit the error history buffer again.

Parameter

Address	Name / setting range / [default setting]	Information
0x2006:000 (P155.00)	Error history buffer: Keypad display (Fault memory: Error memory) • Read only	Display of the error history buffer on the keypad.
0x2006:001	Error history buffer: Maximum number of messages • Read only	Display of the maximum number of messages which can be stored in the history buffer (from subindex 6).

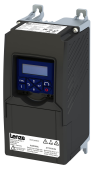

Diagnostics and fault elimination

Error history buffer

Address	Name / setting range / [default setting]	Information
0x2006:002	Error history buffer: Latest message • Read only	Display of the subindex of the most recent message.
0x2006:003	Error history buffer: Latest acknowledgement message 0 ... [0] ... 37	0 = delete all entries in the error history buffer.
0x2006:004	Error history buffer: New message • Read only	Reserved for future extensions.
0x2006:005	Error history buffer: Buffer overflow 0 ... [1] ... 65535	Bit 0 ... bit 4 = 0. Bit 5 = 1 = overflow (after recording the 33rd event in the error history buffer.
	Bit 0 Send emergency message	
	Bit 1 Disable info message	
	Bit 2 Disable warning message	
	Bit 3 Disable error message	
	Bit 4 Mode selection	
Bit 5 Message overwritten		
0x2006:006	Error history buffer: Message 0 • Read only	Error history buffer entry 01 (latest event)
0x2006:007	Error history buffer: Message 1 • Read only	Error history buffer entry 02
0x2006:008	Error history buffer: Message 2 • Read only	Error history buffer entry 03
0x2006:009	Error history buffer: Message 3 • Read only	Error history buffer entry 04
0x2006:010	Error history buffer: Message 4 • Read only	Error history buffer entry 05
0x2006:011	Error history buffer: Message 5 • Read only	Error history buffer entry 06
0x2006:012	Error history buffer: Message 6 • Read only	Error history buffer entry 07
0x2006:013	Error history buffer: Message 7 • Read only	Error history buffer entry 08
0x2006:014	Error history buffer: Message 8 • Read only	Error history buffer entry 09
0x2006:015	Error history buffer: Message 9 • Read only	Error history buffer entry 10
0x2006:016	Error history buffer: Message 10 • Read only	Error history buffer entry 11
0x2006:017	Error history buffer: Message 11 • Read only	Error history buffer entry 12
0x2006:018	Error history buffer: Message 12 • Read only	Error history buffer entry 13
0x2006:019	Error history buffer: Message 13 • Read only	Error history buffer entry 14
0x2006:020	Error history buffer: Message 14 • Read only	Error history buffer entry 15
0x2006:021	Error history buffer: Message 15 • Read only	Error history buffer entry 16
0x2006:022	Error history buffer: Message 16 • Read only	Error history buffer entry 17
0x2006:023	Error history buffer: Message 17 • Read only	Error history buffer entry 18
0x2006:024	Error history buffer: Message 18 • Read only	Error history buffer entry 19
0x2006:025	Error history buffer: Message 19 • Read only	Error history buffer entry 20
0x2006:026	Error history buffer: Message 20 • Read only	Error history buffer entry 21
0x2006:027	Error history buffer: Message 21 • Read only	Error history buffer entry 22

Diagnostics and fault elimination

Error history buffer



Address	Name / setting range / [default setting]	Information
0x2006:028	Error history buffer: Message 22 • Read only	Error history buffer entry 23
0x2006:029	Error history buffer: Message 23 • Read only	Error history buffer entry 24
0x2006:030	Error history buffer: Message 24 • Read only	Error history buffer entry 25
0x2006:031	Error history buffer: Message 25 • Read only	Error history buffer entry 26
0x2006:032	Error history buffer: Message 26 • Read only	Error history buffer entry 27
0x2006:033	Error history buffer: Message 27 • Read only	Error history buffer entry 28
0x2006:034	Error history buffer: Message 28 • Read only	Error history buffer entry 29
0x2006:035	Error history buffer: Message 29 • Read only	Error history buffer entry 30
0x2006:036	Error history buffer: Message 30 • Read only	Error history buffer entry 31
0x2006:037	Error history buffer: Message 31 • Read only	Error history buffer entry 32

Structure of the messages

The following example shows the detailed structure of one of the following messages (parameter 0x2006:006 ... 0x2006:037):

Message:	00E010431201990000520B0473FC0100050001					
	00E01043	1201	9900	00520B0473FC0100	0500	01
Meaning:	Diag code	Message type	Text ID	Time stamp in [ns]	Flag param. 1	Parameter 1
Data type:	U32	U16	U16	U64	U16	U8
Hex value:	0x4310 E000	0x0112	0x0099	0x0001 FC73 040B 5200	0x0005	0x01

Notes:

- The upper 16 bits of the "Diag Code" contain the error code (in the example "0x4310").
- Bit 0 ... 3 of the message type contain the error type (0: Info, 1: Warning, 2: Trouble, 3: Fault).
- Convert time stamp: 0x0001 FC73 040B 5200 = 559045896000000 ns = 6 days, 11 hours, 17 minutes, 25 seconds
- The flag for parameter 1 has no meaning for decoding the message.
- The parameter 1 contains the counter for successive, identical events.



16.3.1 Read out error history buffer

There are two different options to read individual messages of the "error history memory" (in the logbook) from an external control or visualization system:

- Via the standard path defined by "ETG 1020" (EtherCat Technology Group)
- Via simple parameter access to messages in the "error history memory"

Option (b) is described here.

You read diagnostic messages via simple parameter access to the "error history memory".

Parameter

Address	Name / setting range / [default setting]	Information
0x2007:001	Error history buffer: Message number 1 ... [1] ... 32	
0x2007:002	Error history buffer: Time stamp • Read only: x.xx s	
0x2007:003	Error history buffer: Response to error • Read only	
	0 Info (from version 05.01)	
	1 Warning (from version 05.01)	
	2 Error (from version 05.01)	
0x2007:004	Error history buffer: Message ID • Read only	
0x2007:005	Error history buffer: Diag Code Ident • Read only	
0x2007:006	Error history buffer: Message counter • Read only	
0x2007:007	Error history buffer: IO-Link message number • Read only • From version 05.04	

Diagnostics and fault elimination

Diagnostic parameters



16.4 Diagnostic parameters

The inverter provides many diagnostic parameters which are helpful for operation, maintenance, error diagnosis, error correction, etc.

- The following overview lists the most common diagnostic parameters.
- Further parameters for more specific diagnostic purposes are described in the following subchapters.
- The diagnostic parameters can only be read and cannot be written to.
- The diagnostic parameters in group 1 are found on the keypad.

Parameter

Address	Name / setting range / [default setting]	Information
0x2030	CRC parameter set 0 ... [0] ... 4294967295	Display of the 32-bit hash sum for the integrity check of the parameter set.
0x2B0B	Frequency setpoint • Read only: x.x Hz • From version 03.00	Display of the current frequency setpoint. The frequency setpoint is internally transferred to the motor control (based on scaling and ramp generator). The frequency setpoint is internally transferred to the motor control (based on scaling and ramp generator).
0x2B0E (P102.00)	Frequency setpoint (Freq. setpoint) • Read only: x.x Hz	Display of the frequency setpoint currently assigned. • Depending on the present operating conditions, this value may differ from the current output frequency 0x2DDD (P100.00).
0x2B0F	Output frequency motor • Read only: x.x Hz	The inverter controls the motor so that the motor output frequency 0x2B0F corresponds to the frequency setpoint 0x2B0E (P102.00). (Motor output frequency = output frequency of inverter - motor slip)
0x2D4F (P123.00)	Motor utilisation (i ² xt) (Mot. i2t utilis.) • Read only: x %	Display of the current thermal motor utilisation.
0x2D87 (P105.00)	DC-bus voltage (DC-bus voltage) • Read only: x V	Display of the current DC-bus voltage.
0x2D88 (P104.00)	Motor current (Motor current) • Read only: x.x A	Display des present current-r.m.s. value.
0x2D89 (P106.00)	Motor voltage (Motor voltage) • Read only: x VAC	Display of the current motor voltage.
0x2DA2:001 (P108.01)	Output power: Effective power (Output power: Effective power) • Read only: x.xxx kW	Display of the active output power for an energy analysis in the respective application.
0x2DA2:002 (P108.02)	Output power: Apparent power (Output power: Apparent power) • Read only: x.xxx kVA	Display of the apparent output power for an energy analysis in the respective application.
0x2DA3:001 (P109.01)	Output energy: Motor (Output energy: Motor) • Read only: x.xx kWh	Display of the output power in motor mode for an energy analysis in the respective application.
0x2DA3:002 (P109.02)	Output energy: Generator (Output energy: Generator) • Read only: x.xx kWh	Display of the output power in generator mode for an energy analysis in the respective application.
0x2DD1:001	Motor currents: Actual D-current (id) • Read only: x.xx A	Display of the actual D current.
0x2DD1:002	Motor currents: Actual Q-current (iq) • Read only: x.xx A	Display of the actual Q current.
0x2DD1:003	Motor currents: Setpoint D-current (id) • Read only: x.xx A	Display of the setpoint D current.
0x2DD1:004	Motor currents: Setpoint Q-current (iq) • Read only: x.xx A	Display of the setpoint Q current.
0x2DD1:005	Motor currents: Motor current (I _{eff}) • Read only: x.xx A	Display of the effective motor current.
0x2DD3:003	Speed setpoint limited • Read only: x rpm	Display of the limited speed setpoint.

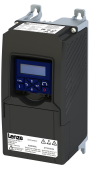

Diagnostics and fault elimination

Diagnostic parameters
Inverter diagnostics

Address	Name / setting range / [default setting]	Information
0x2DDD (P100.00)	Output frequency (Inv. outp. freq.) • Read only: x.x Hz	Display of the current output frequency of the inverter.
0x2DDF:001	Axis information: Rated current • Read only: x.xx A	Display of the rated current of the axis.
0x2DDF:002	Axis information: Maximum current • Read only: x.xx A	Display of the maximum current of the axis.
0x400D (P101.00)	Scaled actual value (Scaled act value) • Read only: x Units	Display of the current speed in application units.
0x6077 (P107.00)	Actual torque (Actual torque) • Read only: x.x %	Display of the actual torque. • 100 % = Rated motor torque 0x6076 (P325.00)
0x6078 (P103.00)	Actual current (Actual current) • Read only: x.x %	Display of the motor actual current. • 100 % = Rated motor current 0x6075 (P323.00)
0x6079	DC-bus voltage • Read only: x.xxx V • From version 02.00	Display of the current DC-bus voltage.

16.4.1 Inverter diagnostics

The following parameters supply some information about the current operating status of the inverter.

This includes the following information:

- Active access protection after log-in by means of PIN1/PIN2
- Currently loaded parameter settings
- Cause(s) for disable, quick stop and stop
- Active control source and active setpoint source
- Active operating mode
- Status of the internal motor control
- Keypad status

Some of the following parameters contain bit-coded status words. Each single bit has a certain meaning.

▶ [Display of status words on keypad](#) [406](#)

Parameter

Address	Name / setting range / [default setting]	Information
0x2040 (P197.00)	Access protection status (Protect. status) • Read only	Bit-coded display of the active access protection after login by PIN1/ PIN2.
	Bit 0 No write access	
	Bit 1 Only favorites changeable	
0x2827 (P198.00)	Currently loaded parameter settings (Status load. par) • Read only	Display of the parameter settings currently loaded. ▶ Behaviour of the inverter in case of incompatible data in the memory module 364 ▶ Saving/loading the parameter settings 348
	0 User settings	User parameter settings of the memory module
	1 Reset 60 Hz setting	Delivery status (default setting) for 50-Hz device
	2 Reset 50 Hz setting	Delivery status (default setting) for 60-Hz device
	3 OEM default settings	OEM parameter settings of the memory module

Diagnostics and fault elimination

Diagnostic parameters
Inverter diagnostics



Address	Name / setting range / [default setting]	Information
0x282A:001 (P126.01)	Status words: Cause of disable (Status words: Cause of disable) • Read only	Bit-coded display of the cause(s) for disabled inverter.
	Bit 0 Flexible I/O configuration	1 = the inverter was disabled by the trigger set in 0x2631:001 (P400.01) .
	Bit 1 Network	1 = the inverter was disabled via network.
	Bit 2 Axis command	1 = the inverter was disabled via axis command .
	Bit 6 Fault DC-bus	1 = The inverter was disabled due to a DC-bus error.
	Bit 7 Drive not ready	1 = the inverter was disabled internally since the drive was not ready for operation. Possible causes: • Under/overvoltage in the DC bus • Defective device hardware
	Bit 8 Quick stop active	1 = the inverter was disabled by the "Quick stop" function.
	Bit 9 Motor data identification	1 = the inverter was disabled by the "Automatic identification of the motor data" function.
	Bit 10 Holding brake	1 = the inverter was disabled by the "Holding brake control" function.
	Bit 11 DC braking	
	Bit 12 CiA402 Inverter disabled	1 = the inverter was disabled by the internal state machine. The bit is only set if • Operating mode 0x6060 (P301.00) = "CiA: Velocity mode [2]" and • state machine in the "Switch on disabled" state and • the state change has not been carried out via the "Disable operation" command.
	Bit 13 CiA402 Quick stop option code 2	1 = the inverter was disabled by the "Quick stop" function.
	Bit 14 Safety	Function is not supported in this device.
	Bit 15 CiA402 operation mode 0	1 = the inverter has been disabled because the selection "No selection [0]" is set in 0x6060 (P301.00) .
0x282A:002 (P126.02)	Status words: Cause of quick stop (Status words: Cause of QSP) • Read only	Bit coded display of the cause(s) of quick stop.
	Bit 0 Flexible I/O configuration	1 = quick stop was activated by the trigger set in 0x2631:003 (P400.03) .
	Bit 1 Network	1 = quick stop was activated via network.
	Bit 2 Axis command	1 = quick stop was activated via axis command .
	Bit 6 Error response	1 = quick stop has been activated as a response to an error.
0x282A:003 (P126.03)	Status words: Cause of stop (Status words: Cause of stop) • Read only	Bit coded display of the cause(s) of stop.
	Bit 0 Flexible I/O: Start disabled	1 = stop was activated by the trigger set in 0x2631:002 (P400.02) .
	Bit 1 Flexible I/O: Run forward	1 = stop has been activated due to cancellation of the command "Run forward (CW)".
	Bit 2 Flexible I/O: Run reverse	1 = stop has been activated due to cancellation of the command "Run reverse (CCW)".
	Bit 3 Flexible I/O: Jog forward	1 = stop has been activated due to cancellation of the command "Jog forward (CW)".
	Bit 4 Flexible I/O: Jog reverse	1 = stop has been activated due to cancellation of the command "Jog reverse (CCW)".
	Bit 5 Network	1 = stop was activated via network.
	Bit 6 Keypad	1 = stop was activated via keypad.
	Bit 7 Control mode transition	1 = stop has been activated due to a change of the operating mode.
	Bit 8 End of sequence	1 = stop was activated by the "sequencer" function since the sequence is completed. • The bit is only set after the sequence is completed if End of sequence mode 0x402F (P824.00) is set = "Stop [1]" or "Stop and abort [2]".
	Bit 9 Manual mode	
	Bit 15 Waiting for start	1 = stop is active as a start command is not yet available (e. g. after enabling the inverter).

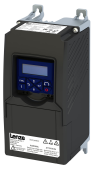

Diagnostics and fault elimination

Diagnostic parameters
Inverter diagnostics

Address	Name / setting range / [default setting]	Information
0x282A:004	Status words: Extended status word • Read only	Bit-coded status word.
	Bit 8 Reverse rotational direction	1 = reversal active.
	Bit 10 Inverter disabled (safety)	Function is not supported in this device.
	Bit 11 STO active	
0x282A:005 (P126.05)	Status words: Device status (Status words: Device status) • Read only	Display of the current inverter device state.
	0 Initialisation	
	2 Not ready to switch on	
	3 Switch on disabled	
	4 Ready to switch on	
	5 Switched on	
	6 Operation enabled	
	7 Disable operation	
	8 Shut down	
	9 Quick stop active	
	10 Fault reaction active	
	11 Fault	
0x282B:001 (P125.01)	Inverter diagnostics: Active control source (Inverter diag.: Active control) • Read only	Display of the control source that is currently active.
	0 Flexible I/O configuration	
	1 Network	
	2 Keypad	
	8 Keypad full control	
	9 Manual mode	
0x282B:002 (P125.02)	Inverter diagnostics: Active setpoint source (Inverter diag.: Active setpoint) • Read only	Display of the setpoint source that is currently active.
	0 Not selected	
	1 Analog input 1	
	2 Analog input 2	
	3 Keypad Setpoint	
	4 HTL input	
	5 Network Setpoint	
	9 Manual mode: setpoint	
	11 Setpoint preset 1	
	12 Setpoint preset 2	
	13 Setpoint preset 3	
	14 Setpoint preset 4	
	15 Setpoint preset 5	
	16 Setpoint preset 6	
	17 Setpoint preset 7	
	18 Setpoint preset 8	
	19 Setpoint preset 9	
	20 Setpoint preset 10	
	21 Setpoint preset 11	
	22 Setpoint preset 12	
	23 Setpoint preset 13	
	24 Setpoint preset 14	
25 Setpoint preset 15		
31 Segment preset 1		
32 Segment preset 2		
33 Segment preset 3		
34 Segment preset 4		

Diagnostics and fault elimination

Diagnostic parameters
Inverter diagnostics



Address	Name / setting range / [default setting]	Information
	35 Segment preset 5	
	36 Segment preset 6	
	37 Segment preset 7	
	38 Segment preset 8	
	39 Last segment	
	50 Motor potentiometer	
	51 PID setpoint (from version 04.00)	
	201 Internal value (from version 05.00)	Internal values of the manufacturer.
	202 Internal value (from version 05.00)	
	203 Internal value (from version 05.00)	
	204 Internal value (from version 05.00)	
	205 Internal value (from version 05.00)	
	206 Internal value (from version 05.00)	
0x282B:003 (P125.03)	Inverter diagnostics: Keypad LCD status (Inverter diag.: Keypad LCD stat.) • Read only	Bit-coded state of the keypad status displays.
	Bit 0 LOC	1 = local keypad control active.
	Bit 1 REM	1 = remote control via terminals, network, etc. active.
	Bit 2 MAN	1 = manual setpoint selection via keypad active.
	Bit 3 Auto	1 = automatic setpoint selection via terminals, network, etc. active.
	Bit 4 Set	1 = a parameter setting has been changed but not been saved yet in the memory module with mains failure protection .
0x282B:004 (P125.04)	Inverter diagnostics: Active drive mode (Inverter diag.: Drive mode) • Read only	Display of the active drive mode.
	0 Velocity mode	"Velocity mode" active.
	1 PID control	PID control active.
	2 Torque mode (from version 03.00)	"Torque mode" active.
	4 Jog operation	"Jog forward (CW)" or "Jog reverse (CCW)" function active.
0x2831	Inverter-Statuswort • Read only	Bit coded status word of the internal motor control.
	Bit 1 Speed setpoint 1 limited	1 = input of speed controller 1 in limitation.
	Bit 2 Speed controller in limitation	1 = output of speed controller 1 in limitation.
	Bit 3 Torque setpoint limited	1 = setpoint torque in limitation.
	Bit 4 Soll-Q-Strom limitiert	1 = setpoint current in limitation.
	Bit 5 Speed setpoint 2 limited	1 = input of speed controller 2 in "torque mode" in limitation.
	Bit 6 Obere Drehzahlgrenze aktiv	1 = in "torque mode", the speed is limited to upper speed limit 0x2946:001 (P340.01) .
	Bit 7 Untere Drehzahlgrenze aktiv	1 = in "torque mode", the speed is limited to lower speed limit 0x2946:002 (P340.02) .
	Bit 8 Flying restart active	-
	Bit 10 Output frequency limited	1 = setpoint frequency with V/f operation in limitation.
	Bit 11 Magnetisation completed	1 = during V/f operation, the factor 7 rotor time constant has passed (calculated from the time at which the inverter was enabled without restart on the fly and with a total motor current of 20 % rated motor current for the first time). Otherwise 0.
	Bit 12 Motorphasenfehler	1 = motor phase failure detection active.
	Bit 14 Error reset blocking time active	1 = the error can only be reset when the blocking time has elapsed.
0x2833	Inverter status word 2 • Read only	Bit-coded status word 2 of the inverter.
	Bit 1 Manual test mode active	1 = manual test mode active.
	Bit 2 Manual control active	1 = manual control active.
	Bit 6 DC braking active	1 = DC braking active.
	Bit 15 UPS operation active	1 = UPS operation active.



Diagnostics and fault elimination

Diagnostic parameters
Network diagnostics

Address	Name / setting range / [default setting]	Information
0x293A (P116.00)	Actual switching frequency (Actual sw. freq.) • Read only	Display of the currently active switching frequency of the inverter. Example: • "16 kHz variable / drive-optimised / 4 kHz min. [22]" is selected as switching frequency in 0x2939 (P305.00) . • An increase of the ambient temperature and/or the load have caused a decrease of the switching frequency to 8 kHz. In this case, this parameter indicates the selection "8 kHz power loss-optimized [7]".
	1 2 kHz drive-optimized	
	2 4 kHz drive-optimized	
	3 8 kHz drive-optimized	
	4 16 kHz drive-optimized	
	5 2 kHz power loss-optimized	
	6 4 kHz power loss-optimized	
	7 8 kHz power loss-optimized	
	8 16 kHz power loss-optimized	
	9 12 kHz drive-optimised	
10 12 kHz power loss-optimised		
0x2DAC (P119.00)	Keypad status (Keypad status) • Read only	Bit-coded display of the keypad status.
	Bit 0 Start Key	1 = keypad start key pressed.
	Bit 1 Stop Key	1 = keypad stop key pressed.
	Bit 2 Up arrow	1 = keypad up-arrow key pressed.
	Bit 3 Down arrow	1 = keypad down-arrow key pressed.
	Bit 4 Enter Key	1 = keypad enter key pressed.
Bit 5 Back key	1 = keypad back key pressed.	
0x2DAD (P120.00)	Internal hardware states (Int. HW states) • Read only	Bit-coded display of internal hardware states.
	Bit 0 Relay	0 = X9/NO-COM open and NC-COM closed. 1 = X9/NO-COM closed and NC-COM open.
	Bit 1 Digital output 1	0 = LOW level, 1 = HIGH level.
	Bit 2 Digital output 2	Function is not supported in this device.
Bit 10 Charge Relay	1 = precharging of the DC bus via charge relay is active.	
0x603F (P150.00)	Error code (Error code) • Read only	Error message

16.4.2 Network diagnostics

The following parameters show some general information with regard to the network option available and the network.

Parameter

Address	Name / setting range / [default setting]	Information
0x282B:005 (P125.05)	Inverter diagnostics: Most recently used control register (Inverter diag.: Netw. contr.reg.) • Read only	Display of the network register for the control that was accessed last (e. g. 0x6040 or 0x400B:1). • Format: 0xiiii:ss00 (iiii = hexadecimal index, ss = hexadecimal subindex) • The lowest byte is always 0x00.
0x282B:006 (P125.06)	Inverter diagnostics: Most recently used setpoint register (Inverter diag.: Netw. setp.reg.) • Read only	Display of the network register for setpoint selection that was accessed last (e. g. 0x6042 or 0x400B:3). • Format: 0xiiii:ss00 (iiii = hexadecimal index, ss = hexadecimal subindex) • The lowest byte is always 0x00.

Diagnostics and fault elimination

Diagnostic parameters
I/O diagnostics



Address	Name / setting range / [default setting]	Information
0x231F:001 (P500.01)	Communication module ID: Active module ID (Module ID: Active module ID) • Read only	Display of the network options currently configured in the device. • With the help of this module ID, the keypad only shows the communication parameters relevant to the respective network. Note! When switched on, the device checks whether the parameter settings saved in the memory module match the device hardware and firmware. In case of an incompatibility, a corresponding error message is output. For details see chapter " Behaviour of the inverter in case of incompatible data in the memory module " (section "Hardware and firmware updates/downgrades"). 364
	48 No network	
	67 CANopen	
	72 BACnet	
	87 Modbus	
0x231F:002 (P500.02)	Communication module ID: Module ID connected (Module ID: Module ID conn.) • Read only	Display of the network options currently available in the device. Note! When switched on, the device checks whether the parameter settings saved in the memory module match the device hardware and firmware. In case of an incompatibility, a corresponding error message is output. For details see chapter " Behaviour of the inverter in case of incompatible data in the memory module " (section "Hardware and firmware updates/downgrades"). 364
	48 No network	
	67 CANopen	
	72 BACnet	
	87 Modbus	

Related topics

▶ [Configuring the network](#) [357](#)

16.4.3 I/O diagnostics

This section describes the diagnostics of the analog and digital inputs and outputs that can be found on the control terminal X3.

16.4.3.1 Digital inputs and outputs

The following parameters serve to diagnose the digital inputs and outputs of the inverter.

Parameter

Address	Name / setting range / [default setting]	Information
0x60FD (P118.00)	Digital input status (Digital inputs) • Read only	Bit coded display of the current status of the digital inputs
	Bit 16 Digital input 1	0 = LOW level, 1 = HIGH level.
	Bit 17 Digital input 2	
	Bit 18 Digital input 3	
	Bit 19 Digital input 4	
	Bit 20 Level from digital input 5	
	Bit 21 Level from digital input 6	Function is not supported in this device.
	Bit 22 Level from digital input 7	
Bit 25 Internal interconnection of digital inputs	0 = digital input terminals are set to HIGH (PNP) level via pull-up resistors. 1 = digital input terminals are set to LOW (PNP) level via pull-down resistors.	



Diagnostics and fault elimination

Diagnostic parameters
I/O diagnostics

Address	Name / setting range / [default setting]	Information
0x2DAD (P120.00)	Internal hardware states (Int. HW states) • Read only	Bit-coded display of internal hardware states.
	Bit 0 Relay	0 = X9/NO-COM open and NC-COM closed. 1 = X9/NO-COM closed and NC-COM open.
	Bit 1 Digital output 1	0 = LOW level, 1 = HIGH level.
	Bit 2 Digital output 2	Function is not supported in this device.
	Bit 10 Charge Relay	1 = precharging of the DC bus via charge relay is active.
0x4016:005	Digital output 1: Terminal state • Read only	Display of the logic state of output terminal X3/DO1.
	0 FALSE	
	1 TRUE	
0x4016:006	Digital output 1: Trigger signal state • Read only	Display of the logic state of the trigger signal for digital output 1 (without taking a ON/OFF delay set and inversion into consideration).
	0 FALSE	
	1 TRUE	
0x4018:005	Relay: Relay state • Read only	Display of the logic state of the relay.
	0 FALSE	
	1 TRUE	
0x4018:006	Relay: Trigger signal state • Read only	Display of the logic state of the trigger signal for the relay (without taking a ON/OFF delay set and inversion into consideration).
	0 FALSE	
	1 TRUE	

Related topics

▶ [Configure digital inputs](#) 237

▶ [Configure digital outputs](#) 247

16.4.3.2 Analog inputs and outputs

The following parameters serve to diagnose the analog inputs and outputs of the inverter.

Parameter

Address	Name / setting range / [default setting]	Information
0x2DA4:001 (P110.01)	Diagnostics of analog input 1: Value in percent (AI1 diagnostics: AI1 terminal %) • Read only: x.x %	Display of the current input value at X3/AI1 scaled as value in percent. • 100 % = 10 V or 20 mA or 5 V
0x2DA4:002 (P110.02)	Diagnostics of analog input 1: Frequency value (AI1 diagnostics: AI1 scaled freq.) • Read only: x.x Hz	Display of the current input value at X3/AI1 scaled as a frequency value. • The standard setpoint source for operating mode 0x6060 (P301.00) = "MS: Velocity mode [-2]" is selected in 0x2860:001 (P201.01) .
0x2DA4:003 (P110.03)	Diagnostics of analog input 1: Process controller value (AI1 diagnostics: AI1 scaled PID) • Read only: x.xx PID unit	Display of the current input value at X3/AI1 scaled as a process controller value. • The standard setpoint source for the reference value of PID control is selected in 0x2860:002 (P201.02) .
0x2DA4:004 (P110.04)	Diagnostics of analog input 1: Torque value (AI1 diagnostics: AI1 scaled torq.) • Read only: x.x %	Display of the current input value at X3/AI1 scaled as a percentage torque value. • 100 % = permissible maximum torque 0x6072 (P326.00) • The standard setpoint source for operating mode 0x6060 (P301.00) = "MS: Torque mode [-1]" is selected in 0x2860:003 (P201.03) .

Diagnostics and fault elimination

Diagnostic parameters
I/O diagnostics



Address	Name / setting range / [default setting]	Information
0x2DA4:016 (P110.16)	Diagnostics of analog input 1: Status (AI1 diagnostics: AI1 status)	Bit coded display of the status of analog input 1 (X3/AI1).
	• Read only	
	• From version 04.00	
	Bit 0 Mode 0: 0 ... 10 VDC active	
	Bit 1 Mode 1: 0 ... 5 VDC active	
	Bit 2 Mode 2: 2 ... 10 VDC active	
	Bit 3 Mode 3: -10 ... 10 VDC active	
	Bit 4 Mode 4: 4 ... 20 mA active	
	Bit 5 Mode 5: 0 ... 20 mA active	
	Bit 6 24 V supply OK	
	Bit 7 Calibration successful	
	Bit 8 Monitoring threshold exceeded/not reached	
Bit 9 Input current too low (mode 4)		
Bit 10 Input voltage too low (mode 2)		
Bit 11 Input voltage too high (mode 4)		
0x2DA5:001 (P111.01)	Diagnostics of analog input 2: Value in percent (AI2 diagnostics: AI2 terminal %)	Display of the current input value at X3/AI2 scaled as a value in percent.
	• Read only: x.x %	• 100 % = 10 V or 20 mA or 5 V
0x2DA5:002 (P111.02)	Diagnostics of analog input 2: Frequency value (AI2 diagnostics: AI2 scaled freq.)	Display of the current input value at X3/AI2 scaled as a frequency value.
	• Read only: x.x Hz	• The standard setpoint source for operating mode 0x6060 (P301.00) = "MS: Velocity mode [-2]" is selected in 0x2860:001 (P201.01) .
0x2DA5:003 (P111.03)	Diagnostics of analog input 2: Process controller value (AI2 diagnostics: AI2 scaled PID)	Display of the current input value at X3/AI2 scaled as a process controller value.
	• Read only: x.xx PID unit	• The standard setpoint source for the reference value of PID control is selected in 0x2860:002 (P201.02) .
0x2DA5:004 (P111.04)	Diagnostics of analog input 2: Torque value (AI2 diagnostics: AI2 scaled torq.)	Display of the current input value at X3/AI2 scaled as a percentage torque value.
	• Read only: x.x %	• 100 % = permissible maximum torque 0x6072 (P326.00)
0x2DA5:016 (P111.16)	Diagnostics of analog input 2: Status (AI2 diagnostics: AI2 status)	Bit-coded display of the status of analog input 2 (X3/AI2).
	• Read only	
	• From version 04.00	
	Bit 0 Mode 0: 0 ... 10 VDC active	
	Bit 1 Mode 1: 0 ... 5 VDC active	
	Bit 2 Mode 2: 2 ... 10 VDC active	
	Bit 3 Mode 3: -10 ... 10 VDC active	
	Bit 4 Mode 4: 4 ... 20 mA active	
	Bit 5 Mode 5: 0 ... 20 mA active	
	Bit 6 24 V supply OK	
	Bit 7 Calibration successful	
	Bit 8 Monitoring threshold exceeded/not reached	
Bit 9 Input current too low		
Bit 10 Input voltage too low		
Bit 11 Input voltage too high		
0x2DAA:001 (P112.01)	Diagnostics of analog output 1: Voltage (AO1 diagnostics: AO1 Voltage)	Display of the current output voltage at X3/AO1.
	• Read only: x.xx V	
0x2DAA:002 (P112.02)	Diagnostics of analog output 1: Current (AO1 diagnostics: AO1 Current)	Display of the present output current at X3/AO1.
	• Read only: x.xx mA	

Related topics

▶ [Configure analog inputs](#) 240

▶ [Configure analog outputs](#) 253

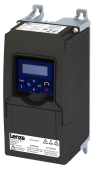

16.4.4 Service life diagnostics

The following parameters provide some information about the use of the inverter.

This includes the following information:

- Operating and power-on time of the inverter/control unit
- Operating time of the internal fan
- Number of switching cycles of the mains voltage
- Number of switching cycles of the relay
- Number of short-circuits and earth faults that have occurred
- Display of the number of "Clamp responded too often" errors that have occurred.

Parameter

Address	Name / setting range / [default setting]	Information
0x2D81:001 (P151.01)	Life-diagnosis: Operating time (Life-diagnosis: Operating time) • Read only: x s	Display showing for how long the device has been running so far (device status "operation enabled").
0x2D81:002 (P151.02)	Life-diagnosis: Power-on time (Life-diagnosis: Power-on time) • Read only: x s	Display showing for how long the device has been supplied with line voltage so far.
0x2D81:003 (P151.03)	Life-diagnosis: Control unit operating time (Life-diagnosis: CU oper. time) • Read only: x ns	Display showing how long the control unit of the inverter has been supplied with voltage via the USB module.
0x2D81:004 (P151.04)	Life-diagnosis: Main switching cycles (Life-diagnosis: Switching cycles) • Read only	Display of the number of switching cycles of the mains voltage.
0x2D81:005 (P151.05)	Life-diagnosis: Relay switching cycles (Life-diagnosis: Relay cycles) • Read only	Display of the number of switching cycles of the relay.
0x2D81:006 (P151.06)	Life-diagnosis: Short-circuit counter (Life-diagnosis: Short-circ.count) • Read only	Display of the number of short circuits that have occurred.
0x2D81:007 (P151.07)	Life-diagnosis: Earth fault counter (Life-diagnosis: Earthfault count) • Read only	Display of the number of earth faults that have occurred.
0x2D81:008 (P151.08)	Life-diagnosis: Clamp active (Life-diagnosis: Clamp active) • Read only	Display of the number of "Clamp responded too often" errors that have occurred. • "Clamp" = short-time inhibit of the inverter in V/f operation when the current limit shown in 0x2DDF:002 is reached.
0x2D81:009 (P151.09)	Life-diagnosis: Fan operating time (Life-diagnosis: Fan oper. time) • Read only: x s	Display showing for how long the internal fan has been running so far.

16.4.5 Device identification

The following parameters show some general information about the inverter.

Parameter

Address	Name / setting range / [default setting]	Information
0x2000:001 (P190.01)	Device data: Product code (Device data: Product code) • Read only	Product code of the complete device.
0x2000:002 (P190.02)	Device data: Serial number (Device data: Serial number) • Read only	Serial number of the complete device. Example: "0000000000000000XYZXYZ"
0x2000:004 (P190.04)	Device data: CU firmware version (Device data: CU firmware ver.) • Read only	Firmware version of the control unit. Example: "01.00.01.00"
0x2000:005 (P190.05)	Device data: CU firmware type (Device data: CU firmware type) • Read only	Firmware type of the control unit. Example: "IOFW51AC10"
0x2000:006 (P190.06)	Device data: CU bootloader version (Device data: CU bootloder ver.) • Read only	Bootloader version of the control unit. Example: "2015.10-20180517"

Diagnostics and fault elimination

Diagnostic parameters
Device identification



Address	Name / setting range / [default setting]	Information
0x2000:007 (P190.07)	Device data: CU bootloader type (Device data: CU bootlдер type) • Read only	Bootloader type of the control unit. Example: "IOBLS1AOnn"
0x2000:008 (P190.08)	Device data: Object directory version (Device data: OBD version) • Read only	Example: "108478"
0x2000:010 (P190.10)	Device data: PU firmware version (Device data: PU firmware ver.) • Read only	Firmware version of the power unit. Example: "00202"
0x2000:011 (P190.11)	Device data: PU firmware type (Device data: PU firmware type) • Read only	Firmware type of the power unit. Example: "IDFW5AA"
0x2000:012 (P190.12)	Device data: PU bootloader version (Device data: PU bootlдер ver.) • Read only	Bootloader version of the power unit.
0x2000:013 (P190.13)	Device data: PU bootloader type (Device data: PU bootlдер type) • Read only	Bootloader type of the power unit.
0x2000:014 (P190.14)	Device data: Module - firmware version (Device data: Mod. firmware) • Read only	Firmware version of the plugged-in module (e.g. WLAN module).
0x2000:015 (P190.15)	Device data: Communication firmware revision number (Device data: Com. FW rev no.) • Read only	Firmware version of the network option.
0x2000:016 (P190.16)	Device data: Communication bootloader revision number (Device data: ComBootlдерRevNo) • Read only	Bootloader version of the network option.
0x2000:017 (P190.17)	Device data: CU firmware subtype (Device data: CU FW subtype) • Read only	Additional information on the firmware.



16.5 Error handling

Many functions integrated in the inverter can

- detect errors and thus protect inverter and motor from damages,
- detect an operating error of the user,
- output a warning or information if desired.

Diagnostics and fault elimination

Error handling
Error types



16.5.1 Error types

In the event of an error, the inverter response is determined by the error type defined for the error.

Error type "No response"

The error is completely ignored (does not affect the running process).

Error type "Warning"

A warning does not severely affect the process and may be also ignored in consideration of safety aspects.

Error type "Fault"

The motor is brought to a standstill with the quick stop ramp.

- The inverter will only be disabled after the quick stop is executed (motor at standstill) or after the time-out time set in [0x2826](#) has been elapsed. ▶ [Timeout for error response](#) [457](#)
- **Exception:** In case of a serious fault, the inverter is disabled immediately. The motor has no torque (coasts). For details see the table "[Error codes, causes and remedies](#)".

Error type "Trouble"

Just like "Fault", but the error state will be left automatically if the error condition is not active anymore.



- **Exception:** In case of a severe trouble, the inverter is disabled immediately. The motor has no torque (coasts). For details see the table "[Error codes, causes and remedies](#)". [461](#)
- The restart behaviour after trouble can be configured. ▶ [Automatic restart after a fault](#) [361](#)



In the operating mode [0x6060 \(P301.00\)](#) = "CiA: Velocity mode [2]", the behaviour in case of "Trouble" is just like in case of "Fault"!

Comparison of the error types

The following table compares the main differences of the error types:

Error type	Logging in the Error history buffer / Logbook	Display in the CiA status word 0x6041 (P780.00)	Inverter disable	Motor stop	Error reset is required	"ERR" LED (red)
No response	No	No	No	No	No	off
Warning	Yes	yes, bit 7	No	No	No	 blinking fast (4 Hz)
Trouble	Yes	yes, bit 3	after quick stop or immediately.	quick stop ramp or coasting.	No	 blinking (1 Hz)
Fault	Yes	yes, bit 3	For details see table " Error codes, causes and remedies ". 461		Yes	 on



16.5.1.1 Timeout for error response

If an error occurs that does not immediately cause a switch-off, the "Fault reaction active" device status initially becomes active. The motor is brought to a standstill with quick stop ramp. The change to the device status "Fault" is only made after the quick stop (motor at standstill) has been executed or after an adjustable timeout time has expired.



Disabling the inverter interrupts the quick stop ramp. The drive coasts immediately.

Details

In the device status "Fault reaction active"

- only the parameters of the inverter can be changed that do not require an inverter disable.
- If a holding brake in brake mode `0x2820:001 (P712.01) = "Automatically (via device state) [0]"` is triggered for closing,
- the motor control continues to be operable.

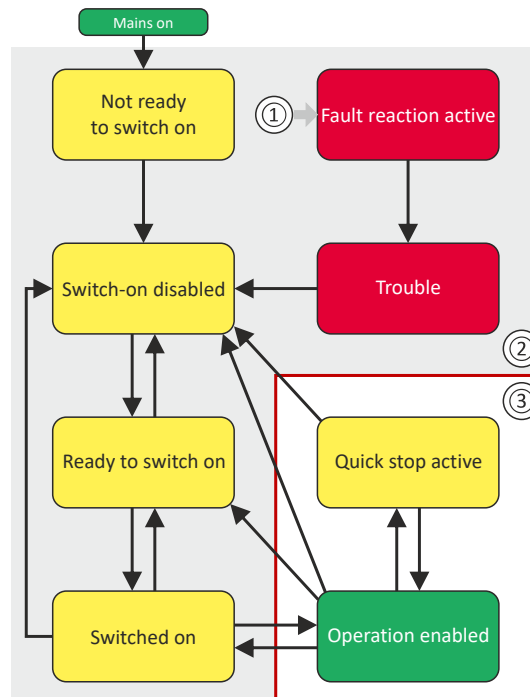

- ① From all states
- ② Power section disabled (pulse inhibit)
- ③ Power section enabled

Diagnostic parameters:

- `0x282A:005 (P126.05)` displays the current device status of the inverter

Parameter

Address	Name / setting range / [default setting]	Information
0x2826	Time-out for error response 0.0 ... [6.0] ... 100.0 s	This timer is started when a change-over to the "Fault reaction active" device status takes place. If the motor is still rotating after the time-out time has elapsed, a change-over to the "Fault" device status takes place. <ul style="list-style-type: none"> • In case of a serious error, an immediate change-over to the "Fault" device status takes place. ⚠ CAUTION! Changing this parameter may cause a longer ramptime in the event of an error. This must be considered when changing this parameter.

Related topics

- ▶ [Automatic restart after a fault](#) 361

Diagnostics and fault elimination

Error handling
Error configuration



16.5.2 Error configuration

The errors can be divided into two types:

- Errors with predefined error type
- Errors with configurable error type

Especially critical errors are permanently set to the "Fault" error type in order to protect inverter and motor from damages.

In case of errors with configurable error type, the default setting can be changed in consideration of safety aspects and the operational performance. The selection "No response [0]" is, however, only available for minor errors.

The "[Error codes, causes and remedies](#)" table lists the error type for each error. If the error type can be configured by the user, the "adjustable in" column displays the corresponding parameter. [461](#)

16.5.3 Error reset

If the error condition is not active anymore, there are several options to reset an active error and thus leave the error state again:

- Via the keypad key . ▶ [Error reset with keypad](#) [402](#)
- Via the trigger assigned to the "Reset fault" function.
- Via the button in the »EASY Starter« ("Diagnostics" tab).
- In the default setting of [0x400E:008 \(P505.08\)](#) via bit 7 in the mappable data word [NetWordIN1 0x4008:001 \(P590.01\)](#).
- Via bit 7 in the mappable CiA control word [0x6040](#).
- Via bit 2 in the mappable AC Drive control word [0x400B:001 \(P592.01\)](#).
- Via bit 11 in the mappable LECOM control word [0x400B:002 \(P592.02\)](#).

Notes:

- Certain errors can only be reset by mains switching.
- Certain errors (e. g. earth fault or short circuit of the motor phases) may cause a blocking time. In this case, the error can be reset only after the blocking time has elapsed. An active blocking time is displayed via bit 14 in the inverter status word [0x2831](#).

The "[Error codes, causes and remedies](#)" table gives the blocking time (if available) for each error. This table also shows whether mains switching is required for the error reset. [461](#)

Parameter

Address	Name / setting range / [default setting]	Information
0x2631:004 (P400.04)	Function list: Reset fault (Function list: Reset fault) <ul style="list-style-type: none">• Further possible settings: ▶ Trigger list 59	Assignment of a trigger for the "Reset fault" function. Trigger = FALSE↗TRUE (edge): The active error is reset (acknowledged) if the error condition no longer exists and the error is resettable. Trigger = FALSE: no action.
	12 Digital input 2	State of X3/DI2, taking an inversion set in 0x2632:002 (P411.02) into consideration.



Diagnostics and fault elimination

Error handling
Error reset

Address	Name / setting range / [default setting]	Information
0x2839:006 (P760.06)	Fault configuration: Fault handling in case of state change (Fault config.: FaultStateChange)	Selection whether a pending error is to be reset via the functions "Enable inverter" 0x2631:001 (P400.01) and "Run" 0x2631:002 (P400.02) as well.
	0 Reset fault	
	1 Do not reset fault	

Example for operating mode

- Switch S1 starts the motor in forward direction of rotation. De-asserting switch S1 stops the motor again.
- Switch S2 resets the current error if the error condition is not active anymore and the error is resettable.
- The switches/sensors S3 and S4 serve to set the inverter from the process to the error status. ▶ [User-defined error triggering](#) 362

Connection plan	Function
	Potentiometer R1 Frequency setpoint selection
	Switch S1 Run
	Switch S2 Reset fault
	Switch S3 Activate fault 1
	Switch S4 Activate fault 2

Parameter	Designation	Setting for this example
0x2631:001 (P400.01)	Enable inverter	Constant TRUE [1]
0x2631:002 (P400.02)	Run	Digital input 1 [11]
0x2631:004 (P400.04)	Reset fault	Digital input 2 [12]
0x2631:013 (P400.13)	Reverse rotational direction	Not connected [0]
0x2631:018 (P400.18)	Activate preset (bit 0)	Not connected [0]
0x2631:043 (P400.43)	Activate fault 1	Digital input 3 [13]
0x2631:044 (P400.44)	Activate fault 2	Digital input 4 [14]
0x2824 (P200.00)	Control selection	Flexible I/O configuration [0]
0x2838:003 (P203.03)	Stop method	Standard ramp [1]
0x2860:001 (P201.01)	Frequency control: Default setpoint source	Analog input 1 [2]
0x2918 (P221.00)	Deceleration time 1	5.0 s
0x291C (P225.00)	Quick stop deceleration time	1.0 s

Diagnostics and fault elimination

Error handling
Error reset



The following signal flow illustrates the reset of an error both with the "Reset error" function ② and by cancelling the start command ④:

Input signals

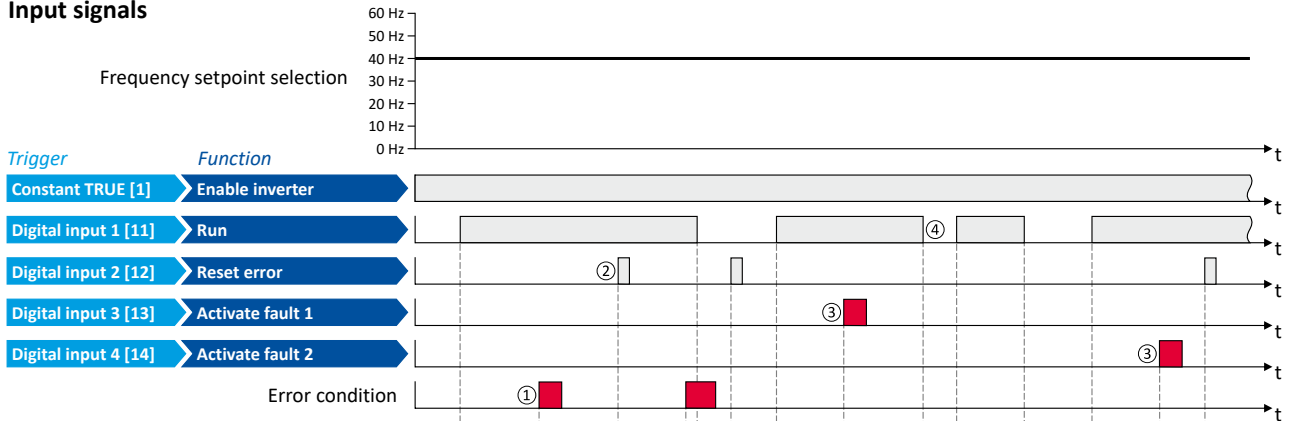

Output signals

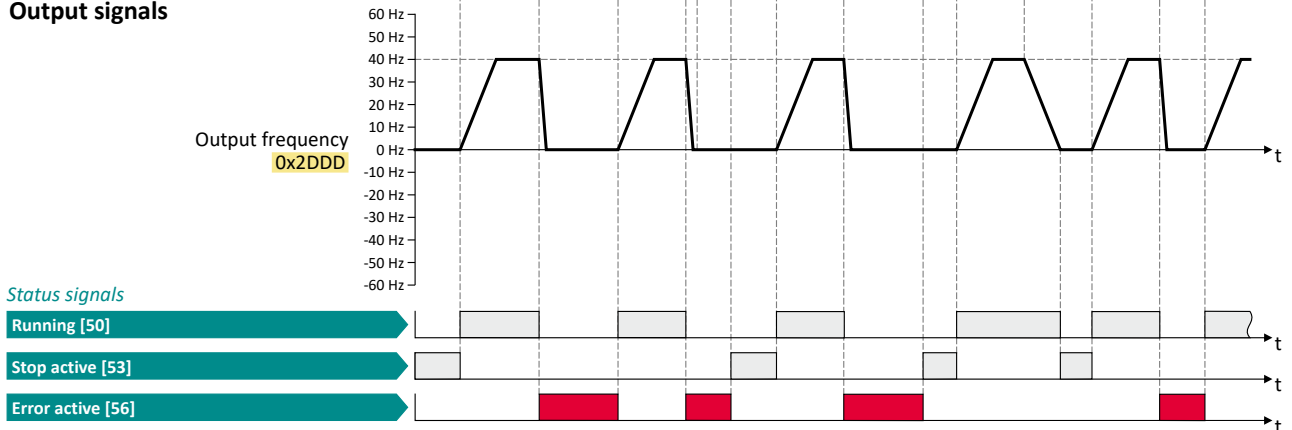

The status signals can be assigned to digital outputs. ▶ [Configure digital outputs](#) 247

- ① If an error condition is active in the inverter, the motor is brought to a standstill with the quick stop ramp. The inverter is then disabled. Exception: In case of a serious error, the inverter is disabled immediately. The motor has no torque (coasts).
- ② If the error can be reset, the error state can be left again with the "Reset fault" function (if the error condition no longer exists). The motor accelerates again to the setpoint since the start command is still active.
- ③ The functions "Activate fault 1" and "Activate fault 2" serve to set the inverter from the process to the error status.
- ④ If the error can be reset, the cancelled start command results in leaving the error state (if the error condition no longer exists).

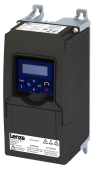

16.6 Error codes, causes and remedies

The following table contains the most important error codes of the device in ascending order.

- Clicking the error code shows you a detailed description of the error message.
- If the device displays an "internal error" that is not listed here, restart the device. If the error persists, make a note of the error code and contact the manufacturer.

Error code	Error message	Error type	Configurable in	
8784	0x2250	CI A: Continuous over current (internal)	Fault	-
8992	0x2320	Short circuit or earth leakage at the motor end	Fault	-
9024	0x2340	Short circuit at the motor end	Fault	-
9040	0x2350	CI A: i ² xt overload (thermal state)	Fault	0x2D4B:003 (P308.03)
9090	0x2382	Fault - Device utilization (ixt) too high	Fault	0x2D40:005 (P135.05)
9091	0x2383	Warning - Device utilization (ixt) too high	Warning	-
9095	0x2387	Clamp responded too often	Fault	-
9096	0x2388	SL-PSM stall detection active	Trouble	-
9098	0x238A	Maximum current reached	Information	-
12576	0x3120	Mains phase fault	Fault	-
12672	0x3180	UPS operation active	Warning	-
12816	0x3210	Fault - DC bus overvoltage	Fault	-
12817	0x3211	DC bus overvoltage warning	Warning	-
12832	0x3220	Fault - DC bus undervoltage	Trouble	-
12833	0x3221	DC bus undervoltage warning	Warning	-
12834	0x3222	DC-bus voltage to low for power up	Warning	-
16912	0x4210	Fault - Power unit overtemperature	Fault	-
17024	0x4280	Fault - Heat sink temperature sensor	Fault	-
17025	0x4281	Heat sink fan warning	Warning	-
17029	0x4285	PU overtemperature warning	Warning	-
20754	0x5112	24 V supply critical	Warning	-
20864	0x5180	Overload 24 V supply	Warning	-
21376	0x5380	OEM hardware incompatible	Fault	-
24970	0x618A	Warning - Internal fan	Warning	-
25216	0x6280	Trigger/functions connected incorrectly	Trouble	-
25217	0x6281	User-defined fault 1	Fault	-
25218	0x6282	User-defined fault 2	Fault	-
25232	0x6290	Warning invert rotation	Warning	-
25233	0x6291	Maximum allowed troubles exceeded	Fault	-
25248	0x62A0	User-defined fault (LECOM)	Fault	-
25249	0x62A1	Network: user fault 1	Fault	-
25250	0x62A2	Network: user fault 2	Fault	-
25265	0x62B1	NetWordIN1 configuration incorrect	Trouble	-
25505	0x63A1	CU: load error ID tag	Fault	-
25506	0x63A2	PU: load error ID tag	Fault	-
25507	0x63A3	Power unit unknown	Fault	-
28800	0x7080	Assertion level monitoring (Low/High)	Fault	-
28801	0x7081	Fault - Analog input 1	Fault	0x2636:010 (P430.10)
28802	0x7082	Analog input 2 fault	Fault	0x2637:010 (P431.10)
28833	0x70A1	Analog output 1 fault	Warning	-
28834	0x70A2	Analog output 2 fault	Warning	-
28961	0x7121	Fault - Pole position identification	Fault	0x2C60
29056	0x7180	Motor overcurrent	Fault	0x2D46:002 (P353.02)
29573	0x7385	Feedback system: speed limit	Warning	-
30336	0x7680	Memory module is full	Warning	-
30337	0x7681	Memory module not present	Fault	-
30338	0x7682	Memory module: Invalid user data	Fault	-
30340	0x7684	Data not compl. saved before powerdown	Warning	-
30345	0x7689	Memory module: invalid OEM data	Warning	-

Diagnostics and fault elimination

Error codes, causes and remedies



Error code	Error message	Error type	Configurable in
30346	0x768A Memory module: wrong type	Fault	-
30352	0x7690 EPM firmware version incompatible	Fault	-
30353	0x7691 EPM data: firmware type incompatible	Fault	-
30354	0x7692 EPM data: new firmware type detected	Fault	-
30355	0x7693 EPM data: PU size incompatible	Fault	-
30356	0x7694 EPM data: new PU size detected	Fault	-
30357	0x7695 Invalid parameter changeover configuration	Warning	-
30358	0x7696 EPM data: unknown parameter found	Information	-
30359	0x7697 Parameter changes lost	Fault	-
33045	0x8115 Time-out (PAM)	No response	0x2552:004 (P595.04)
33154	0x8182 CAN: bus off	Trouble	0x2857:010
33155	0x8183 CAN: warning	Warning	0x2857:011
33156	0x8184 CAN: heartbeat time-out consumer 1	Fault	0x2857:005
33157	0x8185 CAN: heartbeat time-out consumer 2	Fault	0x2857:006
33158	0x8186 CAN: heartbeat time-out consumer 3	Fault	0x2857:007
33159	0x8187 CAN: heartbeat time-out consumer 4	Fault	0x2857:008
33185	0x81A1 Modbus: network time-out	Fault	0x2858:001 (P515.01)
33186	0x81A2 Modbus: incorrect request by master	Warning	-
33425	0x8291 CAN: RPDO1 time-out	Fault	0x2857:001
33426	0x8292 CAN: RPDO2 time-out	Fault	0x2857:002
33427	0x8293 CAN: RPDO3 time-out	Fault	0x2857:003
33553	0x8311 Torque limit reached	No response	0x2D67:001 (P329.01)
33664	0x8380 Function not allowed in selected operating mode	Warning	-
36992	0x9080 Keypad removed	Fault	-
65285	0xFF05 Safety option - Internal error	Fault	-
65286	0xFF06 Motor overspeed	Fault	0x2D44:002 (P350.02)
65289	0xFF09 Motor phase missing	No response	0x2D45:001 (P310.01)
65290	0xFF0A Motor phase failure phase U	No response	0x2D45:001 (P310.01)
65291	0xFF0B Motor phase failure phase V	No response	0x2D45:001 (P310.01)
65292	0xFF0C Motor phase failure phase W	No response	0x2D45:001 (P310.01)
65305	0xFF19 Motor parameter identification fault	Fault	-
65311	0xFF1F FMF Error	Fault	-
65317	0xFF25 Cascading overload	Warning	-
65335	0xFF37 Automatic start disabled	Fault	-
65336	0xFF38 Load loss detected	No response	0x4006:003 (P710.03)
65337	0xFF39 Motor overload	No response	0x4007:003
65366	0xFF56 Maximum motor frequency reached	Warning	-
65370	0xFF5A Manual mode deactivated	Warning	-
65371	0xFF5B Manual mode activated	Warning	-
65372	0xFF5C Manual mode time-out	Fault	-
65393	0xFF71 Wrong password	Warning	-
65394	0xFF72 Warning	Warning	-
65395	0xFF73 Fatal Error	Fault	-
65413	0xFF85 Keypad full control active	Warning	-

8784 | 0x2250 **CIa: Continuous over current (internal)**

Keypad display: **PU over current**

Cause	Remedy	Error type/response
<ul style="list-style-type: none"> Continuous overcurrent on the inverter/ motor side. DC bus relay has not been closed due to a malfunction. 	<ul style="list-style-type: none"> Check motor and wiring for short circuits. 	Fault <ul style="list-style-type: none"> The inverter is disabled immediately. The motor has no torque (is coasting). The error can only be reset after a blocking time.
		Blocking time: 5 s

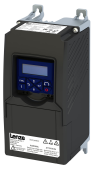

Diagnostics and fault elimination

Error codes, causes and remedies

8992 | 0x2320 **Short circuit or earth leakage at the motor end**

Keypad display: **Earth leak**

Cause	Remedy	Error type/response
<ul style="list-style-type: none"> Short circuit/earth fault of motor cable Capacitive charging current of the motor cable too high. 	<ul style="list-style-type: none"> Check motor cable. Check length of the motor cable. Use shorter or lower-capacitance motor cable. 	Fault <ul style="list-style-type: none"> The inverter is disabled immediately. The motor has no torque (is coasting). The error can only be reset after a blocking time.
		Blocking time: 5 s

9024 | 0x2340 **Short circuit at the motor end**

Keypad display: **Motor shorted**

Cause	Remedy	Error type/response
Short circuit of motor cable	Check motor cable for short circuit.	Fault <ul style="list-style-type: none"> The inverter is disabled immediately. The motor has no torque (is coasting). The error can only be reset after a blocking time.
		Blocking time: 5 s

9040 | 0x2350 **CiA: i²t overload (thermal state)**

Keypad display: **i2t motor**

Cause	Remedy	Error type/response
Motor thermally overloaded, e. g. by an impermissible continuous current or by frequent or too long acceleration processes.	<ul style="list-style-type: none"> Check drive sizing. Check machine/driven mechanics for excessive load. Check settings of the motor data. Reduce values for slip compensation 0x2B09:001 (P315.01), 0x2B09:002 (P315.02) and oscillation damping 0x2B0A:001 (P318.01), 0x2B0A:002 (P318.02). 	Fault (configurable) <ul style="list-style-type: none"> The error can only be reset after a blocking time.
		Blocking time: 5 s
		Setting parameters: 0x2D4B:003 (P308.03)

Related topics

▶ [Motor overload monitoring \(i²t\)](#) [□ 224](#)

9090 | 0x2382 **Fault - Device utilization (ixt) too high**

Keypad display: **Ixt error**

Cause	Remedy	Error type/response
Device utilisation (I*t) too high by frequent and too long acceleration processes.	Check drive sizing. <ul style="list-style-type: none"> Reduce the maximum current of the inverter 0x6073 (P324.00). In case of high mass inertias, reduce maximum current of the inverter 0x6073 (P324.00) to 150 %. 	Fault (configurable) <ul style="list-style-type: none"> The error can only be reset after a blocking time.
		Blocking time: 3 s
		Setting parameters: 0x2D40:005 (P135.05)

Related topics

▶ [Device overload monitoring \(ixt\)](#) [□ 360](#)

9091 | 0x2383 **Warning - Device utilization (ixt) too high**

Keypad display: **Ixt warning**

Cause	Remedy	Error type/response
Device utilisation (I*t) too high by frequent and too long acceleration processes.	Check drive dimensioning.	Warning

Related topics

▶ [Device overload monitoring \(ixt\)](#) [□ 360](#)

Diagnostics and fault elimination

Error codes, causes and remedies



9095 | 0x2387 **Clamp responded too often**

Keypad display: **Clamp timeout**

Cause	Remedy	Error type/response
Maximum current of the axis (display in 0x2DDF:002) has been reached too often in succession.	<ul style="list-style-type: none">• Select a flatter speed ramp.• Reduce the load.• Set I_{max} controller more dynamically.	Fault

Related topics

▶ [I_{max} controller](#) [□ 221](#)

9096 | 0x2388 **SL-PSM stall detection active**

Keypad display: **SL-PSM stall det.**

Cause	Remedy	Error type/response
Overload of the motor with sensorless control for synchronous motors (SL-PSM).	<ul style="list-style-type: none">• Reduce load at the axis.• Check settings of the SL-PSM parameters.	Trouble <ul style="list-style-type: none">• The inverter is disabled immediately. The motor has no torque (is coasting).

Related topics

▶ [Sensorless control for synchronous motor \(SL-PSM\)](#) [□ 162](#)

9098 | 0x238A **Maximum current reached**

Keypad display: **I_{max} reached**

Cause	Remedy	Error type/response
The actual current 0x6078 (P103.00) is equal to or higher than the max. current 0x6073 (P324.00) .	<ul style="list-style-type: none">• Reduce the load on the motor or change the settings for the maximum current. 0x6073 (P324.00)	Information

12576 | 0x3120 **Mains phase fault**

Keypad display: **Mains Phase fail**

Cause	Remedy	Error type/response
Mains phase failure	<ul style="list-style-type: none">• Check wiring of the mains connection.• Check fuses.	Fault

12672 | 0x3180 **UPS operation active**

Keypad display: **UPS oper. active**

Cause	Remedy	Error type/response
Operation on uninterrupted 1x230V current supply (UPS) has been activated: Only a reduced output current is provided.	Switch back to operation with regular mains voltage.	Warning

Related topics

[Operation with UPS](#) [□ 391](#)

12816 | 0x3210 **Fault - DC bus overvoltage**

Keypad display: **DC Bus OV**

Cause	Remedy	Error type/response
DC-bus voltage has exceeded the error threshold for overvoltage due to a too high braking energy or a too high mains voltage. The error threshold (display in 0x2540:006 (P208.06)) results from the setting of the rated mains voltage in 0x2540:001 (P208.01) .	<ul style="list-style-type: none">• Reduce dynamic performance of the load profile.• Check mains voltage.• Check settings for brake energy management.	Fault

Related topics

▶ [Mains voltage](#) [□ 36](#)

▶ [Brake energy management](#) [□ 367](#)

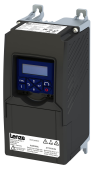

Diagnostics and fault elimination

Error codes, causes and remedies

12817 | 0x3211 **DC bus overvoltage warning**

Keypad display: **Warn.DC Bus OV**

Cause	Remedy	Error type/response
DC-bus voltage has exceeded the warning threshold for overvoltage set in 0x2540:005 (P208.05) due to a too high braking energy or a too high mains voltage.	<ul style="list-style-type: none"> Reduce dynamic performance of the load profile. Check mains voltage. Check settings for brake energy management. 	Warning

Related topics

- ▶ [Mains voltage](#) □ 36
- ▶ [Brake energy management](#) □ 367

12832 | 0x3220 **Fault - DC bus undervoltage**

Keypad display: **DC Bus UV**

Cause	Remedy	Error type/response
DC-bus voltage has fallen below the error threshold for undervoltage. The error threshold (display in 0x2540:003 (P208.03)) results from the setting of the rated mains voltage in 0x2540:001 (P208.01) .	<ul style="list-style-type: none"> Check mains voltage. 0x2D87 (P105.00) Check DC-bus voltage. Check mains settings. Check fuses. 	Trouble

Related topics

- ▶ [Mains voltage](#) □ 36

12833 | 0x3221 **DC bus undervoltage warning**

Keypad display: **Warn.DC Bus UV**

Cause	Remedy	Error type/response
DC-bus voltage has fallen below the warning threshold for undervoltage set in 0x2540:002 (P208.02) .	<ul style="list-style-type: none"> Check mains voltage. 0x2D87 (P105.00) Check DC-bus voltage. Check mains settings. Check fuses. 	Warning

Related topics

- ▶ [Mains voltage](#) □ 36

12834 | 0x3222 **DC-bus voltage to low for power up**

Keypad display: **DC-bus on-UV**

Cause	Remedy	Error type/response
The input voltage is too low to switch on the inverter.	<ul style="list-style-type: none"> Check mains voltage. Check mains settings. Check fuses. 	Warning

Related topics

- ▶ [Mains voltage](#) □ 36

16912 | 0x4210 **Fault - Power unit overtemperature**

Keypad display: **PU Overtemp.**

Cause	Remedy	Error type/response
The heatsink temperature of the power unit (display in 0x2D84:001 (P117.01)) has exceeded the fixed error threshold (100 °C). <ul style="list-style-type: none"> Ambient temperature too high. Fan or ventilation slots are polluted. Fan is defective. 	<ul style="list-style-type: none"> Check mains voltage. Provide for a sufficient cooling of the device. In case of a 100 % load, 60 C to +70°C are normal. Display of the heatsink temperature in 0x2D84:001 (P117.01). Clean fan and ventilation slots. If required, replace fan. Reduce switching frequency 0x2939 (P305.00) 	Fault

Diagnostics and fault elimination

Error codes, causes and remedies



17024 | 0x4280 **Fault - Heat sink temperature sensor**

Keypad display: **Heatsink sensor**

Cause	Remedy	Error type/response
Sensor for the temperature monitoring of the power unit is defective. The failure of the temperature monitoring function poses the risk of overheating!	Hardware error: it is necessary to contact the manufacturer, since the device must be replaced.	Fault

17025 | 0x4281 **Heat sink fan warning**

Keypad display: **Heatsink fan**

Cause	Remedy	Error type/response
Warning of the heatsink fan.	Clean fan and ventilation slots. If required, replace fan. The fans can be unlocked via locking hooks and can then be removed.	Warning

17029 | 0x4285 **PU overtemperature warning**

Keypad display: **Warn.PU Overtemp**

Cause	Remedy	Error type/response
The heatsink temperature of the power unit (display in 0x2D84:001 (P117.01)) has exceeded the warning threshold set in 0x2D84:002 . <ul style="list-style-type: none">Ambient temperature too high.Fan or ventilation slots are polluted.Fan is defective.	<ul style="list-style-type: none">Provide for a sufficient cooling of the device.Clean fan and ventilation slots.If required, replace fan.	Warning

Related topics

▶ [Heatsink temperature monitoring](#) 360

20754 | 0x5112 **24 V supply critical**

Keypad display: **24V supply low**

Cause	Remedy	Error type/response
24V voltage failed or too low.	<ul style="list-style-type: none">Check optional external 24V voltage supply (terminal X3/24E), if connected.Check mains voltage.	Warning

20864 | 0x5180 **Overload 24 V supply**

Keypad display: **Overload 24V**

Cause	Remedy	Error type/response
Output current at the 24V output or at the digital outputs too high.	Check 24V output and digital outputs for earth fault or overload.	Warning

21376 | 0x5380 **OEM hardware incompatible**

Keypad display: **Incomp. OEM HW**

Cause	Remedy	Error type/response
The control unit (OEM hardware) is not compatible with the power unit (OEM hardware).	<ul style="list-style-type: none">Use compatible hardware.Contact the OEM.	Fault <ul style="list-style-type: none">The inverter is disabled immediately. The motor has no torque (is coasting).The error can only be reset by mains switching.

24970 | 0x618A **Warning - Internal fan**

Keypad display: **Internal fan**

Cause	Remedy	Error type/response
Warning of the internal fan.	Check/replace internal fan.	Warning

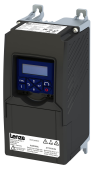

Diagnostics and fault elimination

Error codes, causes and remedies

25216 | 0x6280 **Trigger/functions connected incorrectly**

Keypad display: **P400 config err**

Cause	Remedy	Error type/response
<p>The assignment directives have not been observed.</p> <ul style="list-style-type: none"> If the "flexible I/O configuration" is active as control source, the "Enable inverter" or "Run" function must be connected to a digital input in order that the motor can be stopped again any time! The use of the "Start forward (CW)" and "Start reverse (CCW)" functions excludes the use of the "Run forward (CW)" and "Run reverse (CCW)" functions, and vice versa. 	<p>Check and correct the assignment of the triggers to the functions.</p> <ul style="list-style-type: none"> With keypad or network control, the two "Enable inverter 0x2631:001 (P400.01)" and "Run 0x2631:002 (P400.02)" functions can also be set to "Constant TRUE [1]" to start the motor. 	Trouble

Related topics

▶ [Start, stop and rotating direction commands](#) 49

25217 | 0x6281 **User-defined fault 1**

Keypad display: **User fault 1**

Cause	Remedy	Error type/response
<p>Flexible I/O configuration: the "Activate fault 1" function was activated via the trigger selected in 0x2631:043 (P400.43).</p>	<p>Eliminate error cause and then reset error.</p>	Fault

Related topics

▶ [User-defined error triggering](#) 362

25218 | 0x6282 **User-defined fault 2**

Keypad display: **User fault 2**

Cause	Remedy	Error type/response
<p>Flexible I/O configuration: the "Activate fault 2" function was activated via the trigger selected in 0x2631:044 (P400.44).</p>	<p>Eliminate error cause and then reset error.</p>	Fault

Related topics

▶ [User-defined error triggering](#) 362

25232 | 0x6290 **Warning invert rotation**

Keypad display: **Invert rotation**

Cause	Remedy	Error type/response
<ul style="list-style-type: none"> Negative setpoint selection with an active limitation of rotation 0x283A (P304.00). The "Reverse rotational direction" 0x2631:013 (P400.13) function was requested with an active limitation of rotation 0x283A (P304.00). 	<ul style="list-style-type: none"> Check setpoint selection and trigger. Check setting in 0x283A (P304.00). 	<p>Warning</p> <ul style="list-style-type: none"> The motor is brought to a standstill, since a reversal of the rotating direction is not permissible.

Related topics

▶ [Control/restrict direction of rotation of the motor](#) 71

25233 | 0x6291 **Maximum allowed troubles exceeded**

Keypad display: **Trouble overflow**

Cause	Remedy	Error type/response
<p>The number of permitted restart attempts after a fault set in 0x2839:003 (P760.03) was exceeded. The fault occurred to frequently and could not be reset.</p>	<p>Check and the eliminate the fault.</p>	<p>Fault</p> <ul style="list-style-type: none"> The motor remains at a standstill, no automatic restart is executed.

Related topics

▶ [Automatic restart after a fault](#) 361

Diagnostics and fault elimination

Error codes, causes and remedies



25248 | 0x62A0 **User-defined fault (LECOM)**

Keypad display: **UserFault(LECOM)**

Cause	Remedy	Error type/response
The "Activate fault" function was triggered via bit 10 of the LECOM control word 0x400B:002 (P592.02) .	Eliminate error cause and then reset error.	Fault

25249 | 0x62A1 **Network: user fault 1**

Keypad display: **Netw.UserFault 1**

Cause	Remedy	Error type/response
The "Activate fault 1" function was triggered via the NetWordIN1 data word 0x4008:001 (P590.01) .	Eliminate error cause and then reset error.	Fault

Related topics

▶ [Define your own control word format](#) 261

25250 | 0x62A2 **Network: user fault 2**

Keypad display: **Netw.UserFault 2**

Cause	Remedy	Error type/response
The "Activate fault 2" function was triggered via the NetWordIN1 data word 0x4008:001 (P590.01) .	Eliminate error cause and then reset error.	Fault

Related topics

▶ [Define your own control word format](#) 261

25265 | 0x62B1 **NetWordIN1 configuration incorrect**

Keypad display: **NetWordIN1 error**

Cause	Remedy	Error type/response
Two bits of the NetWordIN1 data word 0x4008:001 (P590.01) were assigned to the same function.	Check and correct configuration of the NetWordIN1 data word. <ul style="list-style-type: none"> The functions that are to be triggered via bits 0 ... 15 of the NetWordIN1 data word are defined in 0x400E:001 (P505.01) ... 0x400E:016 (P505.16). 	Trouble

Related topics

▶ [Define your own control word format](#) 261

25505 | 0x63A1 **CU: load error ID tag**

Keypad display: **CU ID tag error**

Cause	Remedy	Error type/response
Calibration data of the control unit not compatible or faulty.	<ul style="list-style-type: none"> Update firmware of the inverter to the most recent version. If the error persists, the control unit or the device has to be replaced. In this case, please contact the manufacturer. 	Fault <ul style="list-style-type: none"> The inverter is disabled immediately. The motor has no torque (is coasting). The error can only be reset by mains switching.

25506 | 0x63A2 **PU: load error ID tag**

Keypad display: **PU ID tag error**

Cause	Remedy	Error type/response
Calibration data of the power unit not compatible or faulty.	<ul style="list-style-type: none"> Update firmware of the inverter to the most recent version. If the error persists, the power unit or the device has to be replaced. In this case, please contact the manufacturer. 	Fault <ul style="list-style-type: none"> The inverter is disabled immediately. The motor has no torque (is coasting). The error can only be reset by mains switching.

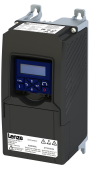

Diagnostics and fault elimination

Error codes, causes and remedies

25507 | 0x63A3 **Power unit unknown**

Keypad display: **PU unknown**

Cause	Remedy	Error type/response
The power unit installed is not supported by the software.	Update firmware of the inverter to the most recent version.	Fault <ul style="list-style-type: none"> The inverter is disabled immediately. The motor has no torque (is coasting). The error can only be reset by mains switching.

28800 | 0x7080 **Assertion level monitoring (Low/High)**

Keypad display: **Assertionlevel**

Cause	Remedy	Error type/response
The last setting of the connection level differs from the saved setting.	<ol style="list-style-type: none"> Execute device command "Save user data" 0x2022:003 (P700.03). Switch inverter off and on again. 	Fault

28801 | 0x7081 **Fault - Analog input 1**

Keypad display: **AI1 fault**

Cause	Remedy	Error type/response
The monitoring function of the input signal configured for analog input 1 in 0x2636:008 (P430.08) and 0x2636:009 (P430.09) has been triggered.	<ul style="list-style-type: none"> Check input signal at analog input 1. Check configuration of the monitoring function. 	Fault (configurable) Setting parameters: 0x2636:010 (P430.10)

28802 | 0x7082 **Analog input 2 fault**

Keypad display: **AI2 fault**

Cause	Remedy	Error type/response
The monitoring function of the input signal configured for analog input 2 in 0x2637:008 (P431.08) and 0x2637:009 (P431.09) has been triggered.	<ul style="list-style-type: none"> Check input signal at analog input 2. Check configuration of the monitoring function. 	Fault (configurable) Setting parameters: 0x2637:010 (P431.10)

28833 | 0x70A1 **Analog output 1 fault**

Keypad display: **AO1 fault**

Cause	Remedy	Error type/response
Open circuit or short circuit at analog output 1.	<ul style="list-style-type: none"> Check wiring of analog output 1. Check definition of the output range in 0x2639:001 (P440.01). 	Warning

Related topics

▶ [Analog output 1](#) 253

28834 | 0x70A2 **Analog output 2 fault**

Keypad display: **AO2 fault**

Cause	Remedy	Error type/response
Error message is not available.		Warning

28961 | 0x7121 **Fault - Pole position identification**

Keypad display: **Pole pos. error**

Cause	Remedy	Error type/response
<ul style="list-style-type: none"> Too many deviations during the pole position identification. Compared to the inverter, the rated motor current is too high or too low. 	<ul style="list-style-type: none"> Check setting of the motor data. Ensure that the motor is at a standstill during the pole position identification process. Ensure that the motor and inverter match each other in terms of power. 	Fault (configurable) Setting parameters: 0x2C60

Diagnostics and fault elimination

Error codes, causes and remedies



29056 | 0x7180 **Motor overcurrent**

Keypad display: **Mot max current**

Cause	Remedy	Error type/response
The motor current has exceeded the warning/error threshold for the motor current monitoring set in 0x2D46:001 (P353.01) .	<ul style="list-style-type: none"> • Check motor load. • Check drive dimensioning. • Check warning threshold or error threshold set in 0x2D46:001 (P353.01). 	Fault (configurable) <ul style="list-style-type: none"> • The error can only be reset after a blocking time.
		Blocking time: 1 s
		Setting parameters: 0x2D46:002 (P353.02)

Related topics

▶ [Overcurrent monitoring](#) □ 228

29573 | 0x7385 **Feedback system: speed limit**

Keypad display: **F.fdb spd limit**

Cause	Remedy	Error type/response
The feedback system exceeds the maximum permissible frequency range of the digital inputs.	Check feedback system.	Warning

Related topics

30336 | 0x7680 **Memory module is full**

Keypad display: **EPM full**

Cause	Remedy	Error type/response
The memory module contains too many parameter settings.	Execute "Save user data" 0x2022:003 (P700.03) device command again. This reinitialises the user memory with the current parameter settings. In this way, parameter settings that are no longer required are automatically deleted.	Warning <ul style="list-style-type: none"> • The parameter settings were not saved in the memory module.

30337 | 0x7681 **Memory module not present**

Keypad display: **EPM not present**

Cause	Remedy	Error type/response
The inverter memory module was removed.	<ol style="list-style-type: none"> 1. Switch off inverter. 2. Plug the memory module into the inverter. 3. Switch the inverter on again. Note: The memory module cannot be replaced during ongoing operation!	Fault <ul style="list-style-type: none"> • The default setting stored in the inverter firmware has been loaded. • The error cannot be reset by the user.

30338 | 0x7682 **Memory module: Invalid user data**

Keypad display: **EPM invalid data**

Cause	Remedy	Error type/response
The user parameter settings in the memory module are invalid.	<ol style="list-style-type: none"> 1. Execute user parameter settings again. 2. Execute device command "Save user data" 0x2022:003 (P700.03). 	Fault <ul style="list-style-type: none"> • The user parameter settings are lost. • The default settings were automatically loaded.

30340 | 0x7684 **Data not compl. saved before powerdown**

Keypad display: **Save incomplete**

Cause	Remedy	Error type/response
Saving of the parameter settings was interrupted by an unexpected disconnection.	<ol style="list-style-type: none"> 1. Check user parameter settings. (The loaded backup is an older version.) 2. If required, repeat the changes made last. 3. Execute device command "Save user data" 0x2022:003 (P700.03). 	Warning <ul style="list-style-type: none"> • The user parameter settings were not fully saved. • At the next switch-on, the data stored are copied to the user memory.



Diagnostics and fault elimination

Error codes, causes and remedies

30345 | 0x7689 **Memory module: invalid OEM data**

Keypad display: **OEM data invalid**

Cause	Remedy	Error type/response
The OEM memory contains invalid parameter settings or is empty.	<ul style="list-style-type: none"> Execute device command "Save OEM data" 0x2022:006 (P700.06). Thus, the user parameter settings get lost! 	Warning <ul style="list-style-type: none"> The user parameter settings were automatically loaded.

30346 | 0x768A **Memory module: wrong type**

Keypad display: **Wrong EPM**

Cause	Remedy	Error type/response
The memory module connected is not supported by the inverter.	<ol style="list-style-type: none"> Switch off inverter. Replace plugged-in memory module by a memory module that matches the inverter. Switch the inverter on again. 	Fault <ul style="list-style-type: none"> The default setting stored in the inverter firmware has been loaded. The error cannot be reset by the user.

30352 | 0x7690 **EPM firmware version incompatible**

Keypad display: **EPM-FW incompat.**

Cause	Remedy	Error type/response
The parameter settings saved in the memory module are incompatible with the firmware version.	<ol style="list-style-type: none"> Execute device command "Load default settings" 0x2022:001 (P700.01). Execute "Save user data" 0x2022:003 (P700.03) or "Save OEM data" 0x2022:006 (P700.06) device command. 	Fault <ul style="list-style-type: none"> The data have been loaded into the RAM memory, but they are incompatible.

30353 | 0x7691 **EPM data: firmware type incompatible**

Keypad display: **EPM: FW incompat.**

Cause	Remedy	Error type/response
The parameter settings saved in the memory module are incompatible with the firmware type. Example: Memory module of an inverter with an application IO is used in an inverter with a standard IO.	<ol style="list-style-type: none"> Execute device command "Load default settings" 0x2022:001 (P700.01). Execute "Save user data" 0x2022:003 (P700.03) or "Save OEM data" 0x2022:006 (P700.06) device command. 	Fault <ul style="list-style-type: none"> The data have been loaded into the RAM memory, but they are incompatible.

30354 | 0x7692 **EPM data: new firmware type detected**

Keypad display: **UserCU not match**

Cause	Remedy	Error type/response
The parameter settings saved in the memory module do not match the inverter hardware.	<ol style="list-style-type: none"> Check parameter settings. Reset error. Execute "Save user data" 0x2022:003 (P700.03) or "Save OEM data" 0x2022:006 (P700.06) device command. 	Fault <ul style="list-style-type: none"> The data have been loaded into the RAM memory without being modified, and they are compatible. The settings loaded must be accepted by the user (see remedy).

30355 | 0x7693 **EPM data: PU size incompatible**

Keypad display: **EPM PU size inco**

Cause	Remedy	Error type/response
The parameter settings saved in the memory module are incompatible with the inverter.	<ol style="list-style-type: none"> Execute device command "Load default settings" 0x2022:001 (P700.01). Execute "Save user data" 0x2022:003 (P700.03) or "Save OEM data" 0x2022:006 (P700.06) device command. 	Fault <ul style="list-style-type: none"> The data have been loaded into the RAM memory, but they are incompatible.

Diagnostics and fault elimination

Error codes, causes and remedies



30356 | 0x7694 **EPM data: new PU size detected**

Keypad display: **EPM new PU size**

Cause	Remedy	Error type/response
The parameter settings saved in the memory module comply with a different hardware. Example: Memory module of an inverter with a power of 3 kW is used in an inverter with a power of 18.5 kW.	<ol style="list-style-type: none"> 1. Check parameter settings. 2. Reset error. 3. Execute "Save user data" 0x2022:003 (P700.03) or "Save OEM data" 0x2022:006 (P700.06) device command. 	Fault <ul style="list-style-type: none"> • The data have been loaded into the RAM memory without being modified, and they are compatible. • The settings loaded must be accepted by the user (see remedy).

30357 | 0x7695 **Invalid parameter changeover configuration**

Keypad display: **InvalidChgovrCfg**

Cause	Remedy	Error type/response
One or more parameters can no longer be used for the "Parameter change-over" function.	<ol style="list-style-type: none"> 1. Check error message for parameter change-over in 0x4047:001 (P756.01). 2. Correct the list entry shown in 0x4047:002 (P756.02). 	Warning <ul style="list-style-type: none"> • The parameter change-over function is deactivated.

30358 | 0x7696 **EPM data: unknown parameter found**

Keypad display: **Unkn. Par in EPM**

Cause	Remedy	Error type/response
The memory module contains parameter settings for one or several parameters that are not known to the inverter.	Execute the "Save user data" 0x2022:003 (P700.03) device command. This reinitialises the user memory with the current parameter settings. In this way, parameter settings that are no longer required are automatically deleted.	Information

30359 | 0x7697 **Parameter changes lost**

Keypad display: **Parameter loss**

Cause	Remedy	Error type/response
A voltage failure has occurred and changed parameter settings that had not been saved yet were available.	<ol style="list-style-type: none"> 1. Execute parameter settings again. 2. Execute device command "Save user data" 0x2022:003 (P700.03). 	Fault <ul style="list-style-type: none"> • The parameter settings changed have been lost.

33045 | 0x8115 **Time-out (PAM)**

Keypad display: **Time-out (PAM)**

Cause	Remedy	Error type/response
The parameter access monitoring (PAM) function has been activated. For a time longer than the time-out period set in 0x2552:003 (P595.03) , no value was entered into the "Keep-alive-Register" 0x2552:002 (P595.02) .	<ul style="list-style-type: none"> • Check communication. • Check settings of the parameter access monitoring (PAM) function. 	No response (configurable)
		Setting parameters: 0x2552:004 (P595.04)

Related topics

▶ [Parameter access monitoring \(PAM\)](#) 282

33154 | 0x8182 **CAN: bus off**

Keypad display: **CAN bus off**

Cause	Remedy	Error type/response
Too many faulty frames have been received. <ul style="list-style-type: none"> • Defective cable (e. g. loose contact). • Two nodes with the same node address. 	<ul style="list-style-type: none"> • Check wiring of the network. • Check bus terminating resistor. • Set the identical baud rate for each node of the network. • Assign a unique node address to each node of the network. • Eliminate EMC interferences. 	Trouble (configurable)
		<ul style="list-style-type: none"> • Change to the "Bus-Off" communication status. Setting parameters: 0x2857:010

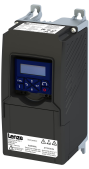

33155 | 0x8183 **CAN: warning**

Keypad display: **CAN bus warning**

Cause	Remedy	Error type/response
Too many faulty frames have been received. <ul style="list-style-type: none"> Defective cable (e. g. loose contact). Two nodes with the same node address. 	<ul style="list-style-type: none"> Check wiring of the network. Check bus terminating resistor. Set the identical baud rate for each node of the network. Assign a unique node address to each node of the network. Eliminate EMC interferences. 	Warning (configurable) Setting parameters: 0x2857:011

33156 | 0x8184 **CAN: heartbeat time-out consumer 1**

Keypad display: **CAN heartb. C1**

Cause	Remedy	Error type/response
Within the heartbeat time 0x1016:001 (P520.01) , no heartbeat telegram was received by node 1 to be monitored.	<ul style="list-style-type: none"> Check communication with the heartbeat producer. Reactivate heartbeat producer. 	Fault (configurable) Setting parameters: 0x2857:005

Related topics

▶ [Heartbeat protocol](#) 325

33157 | 0x8185 **CAN: heartbeat time-out consumer 2**

Keypad display: **CAN heartb. C2**

Cause	Remedy	Error type/response
Within the heartbeat time 0x1016:002 (P520.02) , no heartbeat telegram was received by node 2 to be monitored.	<ul style="list-style-type: none"> Check communication with the heartbeat producer. Reactivate heartbeat producer. 	Fault (configurable) Setting parameters: 0x2857:006

Related topics

▶ [Heartbeat protocol](#) 325

33158 | 0x8186 **CAN: heartbeat time-out consumer 3**

Keypad display: **CAN heartb. C3**

Cause	Remedy	Error type/response
Within the heartbeat time 0x1016:003 (P520.03) , no heartbeat telegram was received by node 3 to be monitored.	<ul style="list-style-type: none"> Check communication with the heartbeat producer. Reactivate heartbeat producer. 	Fault (configurable) Setting parameters: 0x2857:007

Related topics

▶ [Heartbeat protocol](#) 325

33159 | 0x8187 **CAN: heartbeat time-out consumer 4**

Keypad display: **CAN heartb. C4**

Cause	Remedy	Error type/response
Within the heartbeat time 0x1016:004 (P520.04) , no heartbeat telegram was received by node 4 to be monitored.	<ul style="list-style-type: none"> Check communication with the heartbeat producer. Reactivate heartbeat producer. 	Fault (configurable) Setting parameters: 0x2857:008

Related topics

▶ [Heartbeat protocol](#) 325

33185 | 0x81A1 **Modbus: network time-out**

Keypad display: **Modbus time-out**

Cause	Remedy	Error type/response
No valid messages have been received via the Modbus for a longer time than the time-out time set in 0x2858:002 (P515.02) .	<ul style="list-style-type: none"> Check communication with the master. Check wiring. Check bus termination. 	Fault (configurable) Setting parameters: 0x2858:001 (P515.01)

Diagnostics and fault elimination

Error codes, causes and remedies



33186 | 0x81A2 **Modbus: incorrect request by master**

Keypad display: **Modbus request**

Cause	Remedy	Error type/response
The request by the master is invalid, e. g. invalid CRC checksum, non-supported function code, or impermissible data access.	Check request by the master: <ul style="list-style-type: none">• Value in the valid range?• Function code valid?• No impermissible write access? (e. g. with regard to read-only parameters)	Warning The inverter (slave) responds to the master with an error code: <ul style="list-style-type: none">• 0x01 = invalid function code• 0x02 = invalid data address• 0x03 = invalid data value• 0x04 = slave device failure

33425 | 0x8291 **CAN: RPDO1 time-out**

Keypad display: **Timeout RPDO1**

Cause	Remedy	Error type/response
RPDO1 was not received within the time-out period set in 0x1400:005 (P540.05) or with the sync configured.	<ul style="list-style-type: none">• Eliminate EMC interferences.• Check bus load.	Fault (configurable) Setting parameters: 0x2857:001

Related topics

▶ [Process data transfer](#) 315

33426 | 0x8292 **CAN: RPDO2 time-out**

Keypad display: **Timeout RPDO2**

Cause	Remedy	Error type/response
RPDO2 was not received within the time-out period set in 0x1401:005 (P541.05) or with the sync configured.	<ul style="list-style-type: none">• Eliminate EMC interferences.• Check bus load.	Fault (configurable) Setting parameters: 0x2857:002

Related topics

▶ [Process data transfer](#) 315

33427 | 0x8293 **CAN: RPDO3 time-out**

Keypad display: **Timeout RPDO3**

Cause	Remedy	Error type/response
RPDO3 was not received within the time-out period set in 0x1402:005 (P542.05) or with the sync configured.	<ul style="list-style-type: none">• Eliminate EMC interferences.• Check bus load.	Fault (configurable) Setting parameters: 0x2857:003

Related topics

▶ [Process data transfer](#) 315

33553 | 0x8311 **Torque limit reached**

Keypad display: **Torque limit**

Cause	Remedy	Error type/response
Motor has reached the torque limit: <ul style="list-style-type: none">• 0x2949:003 (P337.03): Actual positive torque limit• 0x2949:004 (P337.04): Actual negative torque limit	<ul style="list-style-type: none">• Observe load requirements.• Reduce motor load.• Check set torque limits and sources for the torque limits.	No response (configurable) Setting parameters: 0x2D67:001 (P329.01)

Related topics

▶ [Motor torque monitoring](#) 231



Diagnostics and fault elimination

Error codes, causes and remedies

33664 | 0x8380 **Function not allowed in selected operating mode**

Keypad display: **Func. n. allowed**

Cause	Remedy	Error type/response
<p>The selected function is not permissible in the chosen operating mode.</p> <ul style="list-style-type: none"> Selection of torque mode [-1] in 0x6060 (P301.00) with incompatible motor control in 0x2C00 (P300.00). Selection of invalid drive mode [0] in 0x6060 (P301.00). 	<ul style="list-style-type: none"> Note: selection of torque mode [-1] in 0x6060 (P301.00) with incompatible motor control in 0x2C00 (P300.00). Check settings of operation modes. 0x6060 (P301.00) 	Warning

36992 | 0x9080 **Keypad removed**

Keypad display: **Keypad removed**

Cause	Remedy	Error type/response
<p>The keypad was removed while the keypad control was activated.</p>	<ul style="list-style-type: none"> Plug keypad back in or activate another control source. 	Fault

Related topics

▶ [Changing the control source during operation](#) 72

65285 | 0xFF05 **Safety option - Internal error**

Keypad display: **STO locked**

Cause	Remedy	Error type/response
<p>Error message is not available.</p>		<p>Fault</p> <ul style="list-style-type: none"> The inverter is disabled immediately. The motor has no torque (is coasting). The error can only be reset by mains switching.

65286 | 0xFF06 **Motor overspeed**

Keypad display: **Motor overspeed**

Cause	Remedy	Error type/response
<p>The motor speed has reached the error threshold for overspeed set in 0x2D44:001 (P350.01).</p>	<p>Adapt the maximum motor speed 0x6080 (P322.00) and the warning threshold or error threshold 0x2D44:001 (P350.01).</p>	<p>Fault (configurable)</p> <ul style="list-style-type: none"> The error can only be reset after a blocking time.
		Blocking time: 1 s
		Setting parameters: 0x2D44:002 (P350.02)

Related topics

▶ [Motor speed monitoring](#) 230

65289 | 0xFF09 **Motor phase missing**

Keypad display: **Mot.Phase miss.**

Cause	Remedy	Error type/response
<p>A failure of several motor phases has been detected.</p>	<ul style="list-style-type: none"> Check wiring between inverter and motor. In case of a false tripping, adapt the settings for the motor phase failure detection. 	<p>No response (configurable)</p> <ul style="list-style-type: none"> The error can only be reset after a blocking time.
		Blocking time: 2 s
		Setting parameters: 0x2D45:001 (P310.01)

Related topics

▶ [Motor phase failure detection](#) 229

Diagnostics and fault elimination

Error codes, causes and remedies



65290 | 0xFF0A **Motor phase failure phase U**

Keypad display: **Phase U failure**

Cause	Remedy	Error type/response
A failure of the motor phase U has been detected.	<ul style="list-style-type: none">• Check wiring between inverter and motor.• In case of a false tripping, adapt the settings for the motor phase failure detection.	No response (configurable) <ul style="list-style-type: none">• The error can only be reset after a blocking time.
		Blocking time: 2 s
		Setting parameters: 0x2D45:001 (P310.01)

Related topics

▶ [Motor phase failure detection](#) □ 229

65291 | 0xFF0B **Motor phase failure phase V**

Keypad display: **Phase V failure**

Cause	Remedy	Error type/response
A failure of the motor phase V has been detected.	<ul style="list-style-type: none">• Check wiring between inverter and motor.• In case of a false tripping, adapt the settings for the motor phase failure detection.	No response (configurable) <ul style="list-style-type: none">• The error can only be reset after a blocking time.
		Blocking time: 2 s
		Setting parameters: 0x2D45:001 (P310.01)

Related topics

▶ [Motor phase failure detection](#) □ 229

65292 | 0xFF0C **Motor phase failure phase W**

Keypad display: **Phase W failure**

Cause	Remedy	Error type/response
A failure of the motor phase W has been detected.	<ul style="list-style-type: none">• Check wiring between inverter and motor.• In case of a false tripping, adapt the settings for the motor phase failure detection.	No response (configurable) <ul style="list-style-type: none">• The error can only be reset after a blocking time.
		Blocking time: 2 s
		Setting parameters: 0x2D45:001 (P310.01)

Related topics

▶ [Motor phase failure detection](#) □ 229

65305 | 0xFF19 **Motor parameter identification fault**

Keypad display: **Motor ID fault**

Cause	Remedy	Error type/response
During the automatic identification of the motor, an error has occurred.	<ul style="list-style-type: none">• Set motor data so that they comply with the data on the motor nameplate.• Check wiring of the motor.	Fault

65311 | 0xFF1F **FMF Error**

Keypad display: **FMF Error**

Cause	Remedy	Error type/response
Configuration or runtime error	<ul style="list-style-type: none">• Check configuration• Check FMF error code 0x4050:002 to determine the error cause.	Fault

65317 | 0xFF25 **Cascading overload**

Keypad display: **Cascad. overload**

Cause	Remedy	Error type/response
Cascade function for pumps and fans The maximum frequency in 0x2916 (P211.00) has been reached and no free additional pump is available.	<ul style="list-style-type: none">• Check configuration of the cascade function.• Check drive sizing.	Warning

Related topics

▶ [Cascade function for pumps and fans](#) □ 394



Diagnostics and fault elimination

Error codes, causes and remedies

65335 | 0xFF37 **Automatic start disabled**

Keypad display: **Auto start disab**

Cause	Remedy	Error type/response
At mains connection, a start command was already available and the automatic start at power-up is set in 0x2838:002 (P203.02) to "Off [0]".	Deactivate starting command and reset error.	Fault

65336 | 0xFF38 **Load loss detected**

Keypad display: **Load loss**

Cause	Remedy	Error type/response
In a running motor, the motor load (current) is monitored. When the motor load falls below the threshold value specified in Load loss detection: threshold (0x4006:001 (P710.01)) for the period of time specified in Load loss detection: delay time (0x4006:002 (P710.02)), load loss protection is triggered.	Check utilisation	No response (configurable) Setting parameters: 0x4006:003 (P710.03)

65337 | 0xFF39 **Motor overload**

Keypad display: **Motor overload**

Cause	Remedy	Error type/response
If the apparent motor current exceeds a defined threshold value 0x4007:002 for a certain amount of time 0x4007:001, heavy duty monitoring is triggered.	Check the motor load.	No response (configurable) Setting parameters: 0x4007:003

65366 | 0xFF56 **Maximum motor frequency reached**

Keypad display: **Max. motor freq.**

Cause	Remedy	Error type/response
<ul style="list-style-type: none"> The limitation of the maximum motor speed set in 0x6080 (P322.00) is active. The maximum output frequency of the inverter has been reached. Depending on the parameter setting of 0x2D44:001 (P350.01) (Overspeed monitoring: threshold), the speed limitation (0x6080 / Max. motor speed) may become active before speed monitoring. 	Check application.	Warning

65370 | 0xFF5A **Manual mode deactivated**

Keypad display: **Man. mode deact.**

Cause	Remedy	Error type/response
Indicates the deactivation of the manual speed control.		Warning

65371 | 0xFF5B **Manual mode activated**

Keypad display: **Man. mode act.**

Cause	Remedy	Error type/response
Indicates the activation of the manual speed control.		Warning

Diagnostics and fault elimination

Error codes, causes and remedies



65372 | 0xFF5C **Manual mode time-out**

Keypad display: **ManMode time-out**

Cause	Remedy	Error type/response
If "manual operation" is active, an error is generated in case the communication links get lost.	The error can be only be reset if the connection is restored or the control mode is changed to a different value than "manual operation".	Fault

65393 | 0xFF71 **Wrong password**

Keypad display: **Wrong password**

Cause	Remedy	Error type/response
A wrong password has been entered several times.	Wait until the blocking time has elapsed and then enter the correct password.	Warning <ul style="list-style-type: none">The blocking time for entering a password is more than 10 seconds. (The blocking time is doubled every time an incorrect password is entered.)No password can be entered as long as the blocking time is active.

Related topics

▶ [Access protection](#) 351

65394 | 0xFF72 **Warning**

Keypad display: **Warning**

Cause	Remedy	Error type/response
Inverter is not compatible with the Controller/PLC (brand protection). <ul style="list-style-type: none">The Controller has not written a deactivation password in the parameter yet.The deactivation password written by the Controller is incorrect.	Use corresponding (compatible) OEM components.	Warning <ul style="list-style-type: none">No response from the inverter.The decision on whether the machine will be commissioned or not is made by the Controller.

Related topics

▶ [Access protection](#) 351

65395 | 0xFF73 **Fatal Error**

Keypad display: **Fatal Error**

Cause	Remedy	Error type/response
Error when reading the data from the control unit.	<ul style="list-style-type: none">Switch inverter off and on again.If the error occurs again, the manufacturer must be contacted, since the control unit or the device has to be replaced.	Fault <ul style="list-style-type: none">Operation of the inverter is not possible.

65413 | 0xFF85 **Keypad full control active**

Keypad display: **Keypad full ctrl**

Cause	Remedy	Error type/response
If the "Keypad Full Control" control mode is active.	To exit the control mode, press the keypad key CTRL .	Warning <ul style="list-style-type: none">Both the activity of controlling and the setpoint selection are carried out via the keypad.

Related topics

▶ [Keypad full control](#) 53



17 Technical data



The technical data for the device (dimensions, rated data, standards and operating conditions) can be found in the associated project planning document.



18 Appendix

18.1 Parameter attribute list

The parameter attribute list in particular contains some information required for reading and writing parameters via network.

- The parameter attribute list contains all parameters of the inverter.
- The parameter attribute list is sorted by addresses (index:subindex) in ascending order.

How to read the parameter attribute list:

Column	Meaning
Address	Address of the parameter in the object directory. Format: index:subindex If the parameter can also be accessed via keypad, the "Display Code" is given in addition in brackets.
Name	Parameter name
Default setting	Default setting of the parameter
Category	Functional assignment of the parameter, for example "motor control" or "CANopen".
Data type	Data type of the parameter:
	I8 1 byte, with sign
	I16 2 bytes with sign
	I32 4 bytes with sign
	I64 8 bytes with sign
	U8 1 byte without sign
	U16 2 bytes without sign
	U32 4 bytes without sign
	U64 8 bytes without sign
	REAL32 4 bytes floating point
	STRING[xx] ASCII string (with character length xx)
	OCTET[xx] OCTET string (with xx bytes)
	IDX 4 bytes without sign. Is used specially for addressing parameters.
Factor	Factor for data transmission via network, depending on the number of decimal positions:
	1 No decimal positions
	10 1 decimal position
	100 2 decimal positions
	1000 3 decimal positions
	10000 4 decimal positions
A	Attributes (combinations of several attributes also possible):
	C Setting can only be changed if the inverter is inhibited.
	E Value is displayed as IP address on the keypad.
	H Value is displayed as hexadecimal value on the keypad.
	I Parameter is not displayed.
	k Parameter is only displayed on the keypad.
	O Parameter can be recorded with the oscilloscope function.
	P Setting is saved in the memory module.
	X Parameter is not displayed in the engineering tools.
M	Mapping:
	r Receive mapping permissible.
	t Transmit mapping permissible.
	rt Receive and transmit mapping permissible.
	- Mapping not permissible.

Parameter attribute list (short overview of all parameter indexes)

Address	Name	Default setting	Category	Data type	Factor	A	M
0x1000	Device type	- (Read only)	CANopen	U32	1	H	-
0x1001	Error register	- (Read only)	CANopen	U8	1	H	t
0x1005	COB-ID SYNC	0x00000080	CANopen	U32	1	PH	-
0x1006	Communication cyclic period	0 us	CANopen	U32	1	P	-

* Default setting dependent on the model.

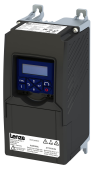

Appendix

Parameter attribute list

Address	Name	Default setting	Category	Data type	Factor	A	M
0x1008	Manufacturer device name	- (Read only)	CANopen	STRING[50]	1	-	-
0x1009	Manufacturer hardware version	- (Read only)	CANopen	STRING[50]	1	-	-
0x100A	Manufacturer software version	- (Read only)	CANopen	STRING[50]	1	-	-
0x1014	COB-ID Emergency telegram (EMCY)	- (Read only)	CANopen	U32	1	H	-
0x1015	Inhibit time EMCY	0.0 ms	CANopen	U16	10	P	-
0x1016:000 (P520.00)	Consumer heartbeat time: Highest sub-index supported	- (Read only)	CANopen	U8	1	-	-
0x1016:001 (P520.01)	Consumer heartbeat time: Consumer heartbeat time 1	0x00000000	CANopen	U32	1	PH	-
0x1016:002 (P520.02)	Consumer heartbeat time: Consumer heartbeat time 2	0x00000000	CANopen	U32	1	PH	-
0x1016:003 (P520.03)	Consumer heartbeat time: Consumer heartbeat time 3	0x00000000	CANopen	U32	1	PH	-
0x1016:004 (P520.04)	Consumer heartbeat time: Consumer heartbeat time 4	0x00000000	CANopen	U32	1	PH	-
0x1017 (P522.00)	Producer heartbeat time	0 ms	CANopen	U16	1	P	-
0x1018:001	Identity object: Vendor ID	- (Read only)	CANopen	U32	1	-	-
0x1018:002	Identity object: Product ID	- (Read only)	CANopen	U32	1	H	-
0x1018:003	Identity object: Revision number	- (Read only)	CANopen	U32	1	-	-
0x1018:004	Identity object: Serial number	- (Read only)	CANopen	U32	1	-	-
0x1029:000	Error behavior: Highest sub-index supported	- (Read only)	CANopen	U8	1	-	-
0x1029:001	Error behavior: Communication error	Status > Pre-operational [0]	CANopen	U8	1	P	-
0x1200:000	SDO1 server parameter: Highest sub-index supported	- (Read only)	CANopen	U8	1	-	-
0x1200:001	SDO1 server parameter: COB-ID client > server (rx)	- (Read only)	CANopen	U32	1	H	-
0x1200:002	SDO1 server parameter: COB-ID server > client (tx)	- (Read only)	CANopen	U32	1	H	-
0x1201:000	SDO2 server parameter: Highest sub-index supported	- (Read only)	CANopen	U8	1	-	-
0x1201:001	SDO2 server parameter: COB-ID client > server (rx)	0x80000640	CANopen	U32	1	PH	-
0x1201:002	SDO2 server parameter: COB-ID server > client (tx)	0x800005C0	CANopen	U32	1	PH	-
0x1201:003	SDO2 server parameter: Node-ID of the SDO client	0	CANopen	U8	1	P	-
0x1400:000	RPDO1 communication parameter: Highest sub-index supported	- (Read only)	CANopen	U8	1	-	-
0x1400:001 (P540.01)	RPDO1 communication parameter: COB-ID	0x00000200	CANopen	U32	1	PH	-
0x1400:002 (P540.02)	RPDO1 communication parameter: Transmission type	255	CANopen	U8	1	P	-
0x1400:005 (P540.05)	RPDO1 communication parameter: Event timer	100 ms	CANopen	U16	1	P	-
0x1401:001 (P541.01)	RPDO2 communication parameter: COB-ID	0x80000300	CANopen	U32	1	PH	-
0x1401:002 (P541.02)	RPDO2 communication parameter: Transmission type	255	CANopen	U8	1	P	-
0x1401:005 (P541.05)	RPDO2 communication parameter: Event timer	100 ms	CANopen	U16	1	P	-
0x1402:001 (P542.01)	RPDO3 communication parameter: COB-ID	0x80000400	CANopen	U32	1	PH	-
0x1402:002 (P542.02)	RPDO3 communication parameter: Transmission type	255	CANopen	U8	1	P	-
0x1402:005 (P542.05)	RPDO3 communication parameter: Event timer	100 ms	CANopen	U16	1	P	-
0x1600:000	RPDO1 mapping parameter: Number of mapped application objects in PDO	2	CANopen	U8	1	P	-
0x1600:001	RPDO1 mapping parameter: Application object 1	0x60400010	CANopen	U32	1	PH	-
0x1600:002	RPDO1 mapping parameter: Application object 2	0x60420010	CANopen	U32	1	PH	-

* Default setting dependent on the model.

Appendix

Parameter attribute list



Address	Name	Default setting	Category	Data type	Factor	A	M
0x1600:003	RPDO1 mapping parameter: Application object 3	0x00000000	CANopen	U32	1	PH	-
0x1600:004	RPDO1 mapping parameter: Application object 4	0x00000000	CANopen	U32	1	PH	-
0x1600:005	RPDO1 mapping parameter: Application object 5	0x00000000	CANopen	U32	1	PH	-
0x1600:006	RPDO1 mapping parameter: Application object 6	0x00000000	CANopen	U32	1	PH	-
0x1600:007	RPDO1 mapping parameter: Application object 7	0x00000000	CANopen	U32	1	PH	-
0x1600:008	RPDO1 mapping parameter: Application object 8	0x00000000	CANopen	U32	1	PH	-
0x1601:000	RPDO2 mapping parameter: Number of mapped application objects in PDO	0	CANopen	U8	1	P	-
0x1601:001	RPDO2 mapping parameter: Application object 1	0x00000000	CANopen	U32	1	PH	-
0x1601:002	RPDO2 mapping parameter: Application object 2	0x00000000	CANopen	U32	1	PH	-
0x1601:003	RPDO2 mapping parameter: Application object 3	0x00000000	CANopen	U32	1	PH	-
0x1601:004	RPDO2 mapping parameter: Application object 4	0x00000000	CANopen	U32	1	PH	-
0x1601:005	RPDO2 mapping parameter: Application object 5	0x00000000	CANopen	U32	1	PH	-
0x1601:006	RPDO2 mapping parameter: Application object 6	0x00000000	CANopen	U32	1	PH	-
0x1601:007	RPDO2 mapping parameter: Application object 7	0x00000000	CANopen	U32	1	PH	-
0x1601:008	RPDO2 mapping parameter: Application object 8	0x00000000	CANopen	U32	1	PH	-
0x1602:000	RPDO3 mapping parameter: Number of mapped application objects in PDO	0	CANopen	U8	1	P	-
0x1602:001	RPDO3 mapping parameter: Application object 1	0x00000000	CANopen	U32	1	PH	-
0x1602:002	RPDO3 mapping parameter: Application object 2	0x00000000	CANopen	U32	1	PH	-
0x1602:003	RPDO3 mapping parameter: Application object 3	0x00000000	CANopen	U32	1	PH	-
0x1602:004	RPDO3 mapping parameter: Application object 4	0x00000000	CANopen	U32	1	PH	-
0x1602:005	RPDO3 mapping parameter: Application object 5	0x00000000	CANopen	U32	1	PH	-
0x1602:006	RPDO3 mapping parameter: Application object 6	0x00000000	CANopen	U32	1	PH	-
0x1602:007	RPDO3 mapping parameter: Application object 7	0x00000000	CANopen	U32	1	PH	-
0x1602:008	RPDO3 mapping parameter: Application object 8	0x00000000	CANopen	U32	1	PH	-
0x1800:000	TPDO1 communication parameter: Highest sub-index supported	- (Read only)	CANopen	U8	1	-	-
0x1800:001 (P550.01)	TPDO1 communication parameter: COB-ID	0x40000180	CANopen	U32	1	PH	-
0x1800:002 (P550.02)	TPDO1 communication parameter: Transmission type	255	CANopen	U8	1	P	-
0x1800:003 (P550.03)	TPDO1 communication parameter: Inhibit time	0.0 ms	CANopen	U16	10	P	-
0x1800:005 (P550.05)	TPDO1 communication parameter: Event timer	20 ms	CANopen	U16	1	P	-
0x1801:000	TPDO2 communication parameter: Highest sub-index supported	- (Read only)	CANopen	U8	1	-	-
0x1801:001 (P551.01)	TPDO2 communication parameter: COB-ID	0xC0000280	CANopen	U32	1	PH	-
0x1801:002 (P551.02)	TPDO2 communication parameter: Transmission type	255	CANopen	U8	1	P	-
0x1801:003 (P551.03)	TPDO2 communication parameter: Inhibit time	0.0 ms	CANopen	U16	10	P	-
0x1801:005 (P551.05)	TPDO2 communication parameter: Event timer	0 ms	CANopen	U16	1	P	-
0x1802:000	TPDO3 communication parameter: Highest sub-index supported	- (Read only)	CANopen	U8	1	-	-
0x1802:001 (P552.01)	TPDO3 communication parameter: COB-ID	0xC0000380	CANopen	U32	1	PH	-
0x1802:002 (P552.02)	TPDO3 communication parameter: Transmission type	255	CANopen	U8	1	P	-
0x1802:003 (P552.03)	TPDO3 communication parameter: Inhibit time	0.0 ms	CANopen	U16	10	P	-
0x1802:005 (P552.05)	TPDO3 communication parameter: Event timer	0 ms	CANopen	U16	1	P	-

* Default setting dependent on the model.

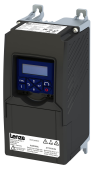

Appendix

Parameter attribute list

Address	Name	Default setting	Category	Data type	Factor	A	M
0x1A00:000	TPDO1 mapping parameter: Number of mapped application objects in TPDO	2	CANopen	U8	1	P	-
0x1A00:001	TPDO1 mapping parameter: Application object 1	0x60410010	CANopen	U32	1	PH	-
0x1A00:002	TPDO1 mapping parameter: Application object 2	0x60440010	CANopen	U32	1	PH	-
0x1A00:003	TPDO1 mapping parameter: Application object 3	0x00000000	CANopen	U32	1	PH	-
0x1A00:004	TPDO1 mapping parameter: Application object 4	0x00000000	CANopen	U32	1	PH	-
0x1A00:005	TPDO1 mapping parameter: Application object 5	0x00000000	CANopen	U32	1	PH	-
0x1A00:006	TPDO1 mapping parameter: Application object 6	0x00000000	CANopen	U32	1	PH	-
0x1A00:007	TPDO1 mapping parameter: Application object 7	0x00000000	CANopen	U32	1	PH	-
0x1A00:008	TPDO1 mapping parameter: Application object 8	0x00000000	CANopen	U32	1	PH	-
0x1A01:000	TPDO2 mapping parameter: Number of mapped application objects in TPDO	0	CANopen	U8	1	P	-
0x1A01:001	TPDO2 mapping parameter: Application object 1	0x00000000	CANopen	U32	1	PH	-
0x1A01:002	TPDO2 mapping parameter: Application object 2	0x00000000	CANopen	U32	1	PH	-
0x1A01:003	TPDO2 mapping parameter: Application object 3	0x00000000	CANopen	U32	1	PH	-
0x1A01:004	TPDO2 mapping parameter: Application object 4	0x00000000	CANopen	U32	1	PH	-
0x1A01:005	TPDO2 mapping parameter: Application object 5	0x00000000	CANopen	U32	1	PH	-
0x1A01:006	TPDO2 mapping parameter: Application object 6	0x00000000	CANopen	U32	1	PH	-
0x1A01:007	TPDO2 mapping parameter: Application object 7	0x00000000	CANopen	U32	1	PH	-
0x1A01:008	TPDO2 mapping parameter: Application object 8	0x00000000	CANopen	U32	1	PH	-
0x1A02:000	TPDO3 mapping parameter: Number of mapped application objects in TPDO	0	CANopen	U8	1	P	-
0x1A02:001	TPDO3 mapping parameter: Application object 1	0x00000000	CANopen	U32	1	PH	-
0x1A02:002	TPDO3 mapping parameter: Application object 2	0x00000000	CANopen	U32	1	PH	-
0x1A02:003	TPDO3 mapping parameter: Application object 3	0x00000000	CANopen	U32	1	PH	-
0x1A02:004	TPDO3 mapping parameter: Application object 4	0x00000000	CANopen	U32	1	PH	-
0x1A02:005	TPDO3 mapping parameter: Application object 5	0x00000000	CANopen	U32	1	PH	-
0x1A02:006	TPDO3 mapping parameter: Application object 6	0x00000000	CANopen	U32	1	PH	-
0x1A02:007	TPDO3 mapping parameter: Application object 7	0x00000000	CANopen	U32	1	PH	-
0x1A02:008	TPDO3 mapping parameter: Application object 8	0x00000000	CANopen	U32	1	PH	-
0x2000:001 (P190.01)	Device data: Product code	-(Read only)	general	STRING[18]	1	-	-
0x2000:002 (P190.02)	Device data: Serial number	-(Read only)	general	STRING[50]	1	-	-
0x2000:004 (P190.04)	Device data: CU firmware version	-(Read only)	general	STRING[50]	1	-	-
0x2000:005 (P190.05)	Device data: CU firmware type	-(Read only)	general	STRING[50]	1	-	-
0x2000:006 (P190.06)	Device data: CU bootloader version	-(Read only)	general	STRING[50]	1	-	-
0x2000:007 (P190.07)	Device data: CU bootloader type	-(Read only)	general	STRING[50]	1	-	-
0x2000:008 (P190.08)	Device data: Object directory version	-(Read only)	general	U32	1	-	-
0x2000:010 (P190.10)	Device data: PU firmware version	-(Read only)	general	STRING[50]	1	-	-
0x2000:011 (P190.11)	Device data: PU firmware type	-(Read only)	general	STRING[50]	1	-	-
0x2000:012 (P190.12)	Device data: PU bootloader version	-(Read only)	general	STRING[50]	1	-	-
0x2000:013 (P190.13)	Device data: PU bootloader type	-(Read only)	general	STRING[50]	1	-	-
0x2000:014 (P190.14)	Device data: Module - firmware version	-(Read only)	general	STRING[11]	1	-	-
0x2000:015 (P190.15)	Device data: Communication firmware revision number	-(Read only)	general	STRING[50]	1	-	-

* Default setting dependent on the model.

Appendix

Parameter attribute list



Address	Name	Default setting	Category	Data type	Factor	A	M
0x2000:016 (P190.16)	Device data: Communication bootloader revision number	- (Read only)	general	STRING[50]	1	-	-
0x2000:017 (P190.17)	Device data: CU firmware subtype	- (Read only)	general	STRING[50]	1	-	-
0x2001 (P191.00)	Device name	"My Device"	general	STRING[128]	1	P	-
0x2006:000 (P155.00)	Error history buffer: Keypad display	- (Read only)	general	U8	1	-	-
0x2006:001	Error history buffer: Maximum number of messages	- (Read only)	general	U8	1	-	-
0x2006:002	Error history buffer: Latest message	- (Read only)	general	U8	1	-	-
0x2006:003	Error history buffer: Latest acknowledgement message	0	general	U8	1	-	-
0x2006:004	Error history buffer: New message	- (Read only)	general	U8	1	-	t
0x2006:005	Error history buffer: Buffer overflow	1	general	U16	1	-	-
0x2006:006	Error history buffer: Message 0	- (Read only)	general	OCTET[19]	1	-	-
0x2006:007	Error history buffer: Message 1	- (Read only)	general	OCTET[19]	1	-	-
0x2006:008	Error history buffer: Message 2	- (Read only)	general	OCTET[19]	1	-	-
0x2006:009	Error history buffer: Message 3	- (Read only)	general	OCTET[19]	1	-	-
0x2006:010	Error history buffer: Message 4	- (Read only)	general	OCTET[19]	1	-	-
0x2006:011	Error history buffer: Message 5	- (Read only)	general	OCTET[19]	1	-	-
0x2006:012	Error history buffer: Message 6	- (Read only)	general	OCTET[19]	1	-	-
0x2006:013	Error history buffer: Message 7	- (Read only)	general	OCTET[19]	1	-	-
0x2006:014	Error history buffer: Message 8	- (Read only)	general	OCTET[19]	1	-	-
0x2006:015	Error history buffer: Message 9	- (Read only)	general	OCTET[19]	1	-	-
0x2006:016	Error history buffer: Message 10	- (Read only)	general	OCTET[19]	1	-	-
0x2006:017	Error history buffer: Message 11	- (Read only)	general	OCTET[19]	1	-	-
0x2006:018	Error history buffer: Message 12	- (Read only)	general	OCTET[19]	1	-	-
0x2006:019	Error history buffer: Message 13	- (Read only)	general	OCTET[19]	1	-	-
0x2006:020	Error history buffer: Message 14	- (Read only)	general	OCTET[19]	1	-	-
0x2006:021	Error history buffer: Message 15	- (Read only)	general	OCTET[19]	1	-	-
0x2006:022	Error history buffer: Message 16	- (Read only)	general	OCTET[19]	1	-	-
0x2006:023	Error history buffer: Message 17	- (Read only)	general	OCTET[19]	1	-	-
0x2006:024	Error history buffer: Message 18	- (Read only)	general	OCTET[19]	1	-	-
0x2006:025	Error history buffer: Message 19	- (Read only)	general	OCTET[19]	1	-	-
0x2006:026	Error history buffer: Message 20	- (Read only)	general	OCTET[19]	1	-	-
0x2006:027	Error history buffer: Message 21	- (Read only)	general	OCTET[19]	1	-	-
0x2006:028	Error history buffer: Message 22	- (Read only)	general	OCTET[19]	1	-	-
0x2006:029	Error history buffer: Message 23	- (Read only)	general	OCTET[19]	1	-	-
0x2006:030	Error history buffer: Message 24	- (Read only)	general	OCTET[19]	1	-	-
0x2006:031	Error history buffer: Message 25	- (Read only)	general	OCTET[19]	1	-	-
0x2006:032	Error history buffer: Message 26	- (Read only)	general	OCTET[19]	1	-	-
0x2006:033	Error history buffer: Message 27	- (Read only)	general	OCTET[19]	1	-	-
0x2006:034	Error history buffer: Message 28	- (Read only)	general	OCTET[19]	1	-	-
0x2006:035	Error history buffer: Message 29	- (Read only)	general	OCTET[19]	1	-	-
0x2006:036	Error history buffer: Message 30	- (Read only)	general	OCTET[19]	1	-	-
0x2006:037	Error history buffer: Message 31	- (Read only)	general	OCTET[19]	1	-	-
0x2007:001	Error history buffer: Message number	1	general	U8	1	-	-
0x2007:002	Error history buffer: Time stamp	x.xx s (Read only)	general	U32	100	-	-
0x2007:003	Error history buffer: Response to error	- (Read only)	general	U8	1	-	-
0x2007:004	Error history buffer: Message ID	- (Read only)	general	U16	1	-	-
0x2007:005	Error history buffer: Diag Code Ident	- (Read only)	general	U16	1	-	-
0x2007:006	Error history buffer: Message counter	- (Read only)	general	U8	1	-	-
0x2007:007	Error history buffer: IO-Link message number	- (Read only)	IO-Link	U16	1	-	-
0x2021:001 (P230.01)	Optical tracking: Start detection	Stop [0]	general	U8	1	-	-

* Default setting dependent on the model.

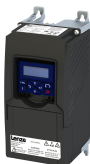

Address	Name	Default setting	Category	Data type	Factor	A	M
0x2021:002 (P230.02)	Optical tracking: Blinking duration	5 s	general	U16	1	-	-
0x2022:001 (P700.01)	Device commands: Load default settings	Off / ready [0]	general	U8	1	C	-
0x2022:003 (P700.03)	Device commands: Save user data	Off / ready [0]	general	U8	1	-	-
0x2022:004 (P700.04)	Device commands: Load user data	Off / ready [0]	general	U8	1	C	-
0x2022:005 (P700.05)	Device commands: Load OEM data	Off / ready [0]	general	U8	1	C	-
0x2022:006 (P700.06)	Device commands: Save OEM data	Off / ready [0]	general	U8	1	-	-
0x2022:007 (P700.07)	Device commands: Load parameter set 1	Off / ready [0]	general	U8	1	-	-
0x2022:008 (P700.08)	Device commands: Load parameter set 2	Off / ready [0]	general	U8	1	-	-
0x2022:009 (P700.09)	Device commands: Load parameter set 3	Off / ready [0]	general	U8	1	-	-
0x2022:010 (P700.10)	Device commands: Load parameter set 4	Off / ready [0]	general	U8	1	-	-
0x2022:011 (P700.11)	Device commands: Save parameter set 1	Off / ready [0]	general	U8	1	-	-
0x2022:012 (P700.12)	Device commands: Save parameter set 2	Off / ready [0]	general	U8	1	-	-
0x2022:013 (P700.13)	Device commands: Save parameter set 3	Off / ready [0]	general	U8	1	-	-
0x2022:014 (P700.14)	Device commands: Save parameter set 4	Off / ready [0]	general	U8	1	-	-
0x2022:015 (P700.15)	Device commands: Delete logbook	Off / ready [0]	general	U8	1	C	-
0x2024:001	Special settings: Configure default setting	0	general	U16	1	-	-
0x2030	CRC parameter set	0	general	U32	1	P	-
0x203D (P730.00)	PIN1 access protection	0	general	I16	1	-	-
0x203E (P731.00)	PIN2 access protection	0	general	I16	1	-	-
0x203F	PIN1/PIN2 log-in	0	general	I16	1	-	-
0x2040 (P197.00)	Access protection status	- (Read only)	general	U16	1	-	-
0x2300 (P508.00)	CANopen communication	No action/no error [0]	CANopen	U8	1	C	-
0x2301:001 (P510.01)	CANopen settings: Node ID	1	CANopen	U8	1	P	-
0x2301:002 (P510.02)	CANopen settings: Baud rate	500 kbps [5]	CANopen	U8	1	P	-
0x2301:003 (P510.03)	CANopen settings: Slave/Master	Slave [0]	CANopen	U8	1	P	-
0x2301:004 (P510.04)	CANopen settings: Start remote delay	3000 ms	CANopen	U16	1	P	-
0x2301:005 (P510.05)	CANopen settings: Activate SDO2 channel	Not active [0]	CANopen	U8	1	-	-
0x2301:006 (P510.06)	CANopen settings: COB-ID Configuration - PDO	Base + node-ID [0]	CANopen	U8	1	P	-
0x2301:007 (P510.07)	CANopen settings: COB-ID Configuration - SDO2	Freely configurable [1]	CANopen	U8	1	P	-
0x2302:001 (P511.01)	Active CANopen settings: Active node ID	- (Read only)	CANopen	U8	1	-	-
0x2302:002 (P511.02)	Active CANopen settings: Active baud rate	- (Read only)	CANopen	U8	1	-	-

* Default setting dependent on the model.

Appendix

Parameter attribute list



Address	Name	Default setting	Category	Data type	Factor	A	M
0x2307 (P515.00)	CANopen time-out status	- (Read only)	CANopen	U32	1	-	-
0x2308 (P516.00)	CANopen status	- (Read only)	CANopen	U16	1	-	-
0x2309 (P517.00)	CANopen controller status	- (Read only)	CANopen	U16	1	-	-
0x230A:000	CANopen statistics: Highest subindex	- (Read only)	CANopen	U8	1	-	-
0x230A:001 (P580.01)	CANopen statistics: PDO1 received	- (Read only)	CANopen	U16	1	-	-
0x230A:002 (P580.02)	CANopen statistics: PDO2 received	- (Read only)	CANopen	U16	1	-	-
0x230A:003 (P580.03)	CANopen statistics: PDO3 received	- (Read only)	CANopen	U16	1	-	-
0x230A:005 (P580.05)	CANopen statistics: PDO1 transmitted	- (Read only)	CANopen	U16	1	-	-
0x230A:006 (P580.06)	CANopen statistics: PDO2 transmitted	- (Read only)	CANopen	U16	1	-	-
0x230A:007 (P580.07)	CANopen statistics: PDO3 transmitted	- (Read only)	CANopen	U16	1	-	-
0x230A:009 (P580.09)	CANopen statistics: SDO1 telegrams	- (Read only)	CANopen	U16	1	-	-
0x230A:010 (P580.10)	CANopen statistics: SDO2 telegrams	- (Read only)	CANopen	U16	1	-	-
0x230B (P518.00)	CANopen error counter	- (Read only)	CANopen	U16	1	-	-
0x231F:001 (P500.01)	Communication module ID: Active module ID	- (Read only)	general	U8	1	P	-
0x231F:002 (P500.02)	Communication module ID: Module ID connected	- (Read only)	general	U8	1	-	-
0x2320 (P508.00)	Modbus communication	No action/no error [0]	Modbus RTU	U8	1	-	-
0x2321:001 (P510.01)	Modbus settings: Node ID	1	Modbus RTU	U8	1	P	-
0x2321:002 (P510.02)	Modbus settings: Baud rate	Automatic [0]	Modbus RTU	U8	1	P	-
0x2321:003 (P510.03)	Modbus settings: Data format	Automatic [0]	Modbus RTU	U8	1	P	-
0x2321:004 (P510.04)	Modbus settings: Minimum response time	0 ms	Modbus RTU	U16	1	P	-
0x2322:001 (P511.01)	Active Modbus settings: Active node ID	- (Read only)	Modbus RTU	U8	1	-	-
0x2322:002 (P511.02)	Active Modbus settings: Active baud rate	- (Read only)	Modbus RTU	U8	1	-	-
0x2322:003 (P511.03)	Active Modbus settings: Data format	- (Read only)	Modbus RTU	U8	1	-	-
0x232A:001 (P580.01)	Modbus statistics: Messages received	- (Read only)	Modbus RTU	U32	1	-	-
0x232A:002 (P580.02)	Modbus statistics: Valid messages received	- (Read only)	Modbus RTU	U32	1	-	-
0x232A:003 (P580.03)	Modbus statistics: Messages with exceptions	- (Read only)	Modbus RTU	U32	1	-	-
0x232A:004 (P580.04)	Modbus statistics: Messages with errors	- (Read only)	Modbus RTU	U32	1	-	-
0x232A:005 (P580.05)	Modbus statistics: Messages sent	- (Read only)	Modbus RTU	U32	1	-	-
0x232B:001 ... 0x232B:024 (P530.01 ... 24)	Modbus parameter mapping: Parameter 1 ... Parameter 24	0x00000000	Modbus RTU	IDX	1	PH	-

* Default setting dependent on the model.

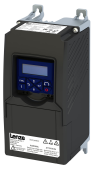

Appendix

Parameter attribute list

Address	Name	Default setting	Category	Data type	Factor	A	M
0x232C:001 ... 0x232C:024 (P531.01 ... 24)	Modbus register assignment: Register 1 ... Register 24	- (Read only)	Modbus RTU	U16	1	-	-
0x232D (P532.00)	Modbus verification code	- (Read only)	Modbus RTU	U16	1	-	-
0x232E:001 (P583.01)	Modbus diagnostics of last Rx data: Offset	0	Modbus RTU	U8	1	-	-
0x232E:002 (P583.02)	Modbus diagnostics of last Rx data: Data byte 0	- (Read only)	Modbus RTU	U8	1	-	-
0x232E:003 (P583.03)	Modbus diagnostics of last Rx data: Data byte 1	- (Read only)	Modbus RTU	U8	1	-	-
0x232E:004 (P583.04)	Modbus diagnostics of last Rx data: Data byte 2	- (Read only)	Modbus RTU	U8	1	-	-
0x232E:005 (P583.05)	Modbus diagnostics of last Rx data: Data byte 3	- (Read only)	Modbus RTU	U8	1	-	-
0x232E:006 (P583.06)	Modbus diagnostics of last Rx data: Data byte 4	- (Read only)	Modbus RTU	U8	1	-	-
0x232E:007 (P583.07)	Modbus diagnostics of last Rx data: Data byte 5	- (Read only)	Modbus RTU	U8	1	-	-
0x232E:008 (P583.08)	Modbus diagnostics of last Rx data: Data byte 6	- (Read only)	Modbus RTU	U8	1	-	-
0x232E:009 (P583.09)	Modbus diagnostics of last Rx data: Data byte 7	- (Read only)	Modbus RTU	U8	1	-	-
0x232E:010 (P583.10)	Modbus diagnostics of last Rx data: Data byte 8	- (Read only)	Modbus RTU	U8	1	-	-
0x232E:011 (P583.11)	Modbus diagnostics of last Rx data: Data byte 9	- (Read only)	Modbus RTU	U8	1	-	-
0x232E:012 (P583.12)	Modbus diagnostics of last Rx data: Data byte 10	- (Read only)	Modbus RTU	U8	1	-	-
0x232E:013 (P583.13)	Modbus diagnostics of last Rx data: Data byte 11	- (Read only)	Modbus RTU	U8	1	-	-
0x232E:014 (P583.14)	Modbus diagnostics of last Rx data: Data byte 12	- (Read only)	Modbus RTU	U8	1	-	-
0x232E:015 (P583.15)	Modbus diagnostics of last Rx data: Data byte 13	- (Read only)	Modbus RTU	U8	1	-	-
0x232E:016 (P583.16)	Modbus diagnostics of last Rx data: Data byte 14	- (Read only)	Modbus RTU	U8	1	-	-
0x232E:017 (P583.17)	Modbus diagnostics of last Rx data: Data byte 15	- (Read only)	Modbus RTU	U8	1	-	-
0x232F:001 (P585.01)	Modbus diagnostics of last Tx data: Offset	0	Modbus RTU	U8	1	-	-
0x232F:002 (P585.02)	Modbus diagnostics of last Tx data: Data byte 0	- (Read only)	Modbus RTU	U8	1	-	-
0x232F:003 (P585.03)	Modbus diagnostics of last Tx data: Data byte 1	- (Read only)	Modbus RTU	U8	1	-	-
0x232F:004 (P585.04)	Modbus diagnostics of last Tx data: Data byte 2	- (Read only)	Modbus RTU	U8	1	-	-
0x232F:005 (P585.05)	Modbus diagnostics of last Tx data: Data byte 3	- (Read only)	Modbus RTU	U8	1	-	-
0x232F:006 (P585.06)	Modbus diagnostics of last Tx data: Data byte 4	- (Read only)	Modbus RTU	U8	1	-	-
0x232F:007 (P585.07)	Modbus diagnostics of last Tx data: Data byte 5	- (Read only)	Modbus RTU	U8	1	-	-
0x232F:008 (P585.08)	Modbus diagnostics of last Tx data: Data byte 6	- (Read only)	Modbus RTU	U8	1	-	-
0x232F:009 (P585.09)	Modbus diagnostics of last Tx data: Data byte 7	- (Read only)	Modbus RTU	U8	1	-	-
0x232F:010 (P585.10)	Modbus diagnostics of last Tx data: Data byte 8	- (Read only)	Modbus RTU	U8	1	-	-

* Default setting dependent on the model.

Appendix

Parameter attribute list



Address	Name	Default setting	Category	Data type	Factor	A	M
0x232F:011 (P585.11)	Modbus diagnostics of last Tx data: Data byte 9	- (Read only)	Modbus RTU	U8	1	-	-
0x232F:012 (P585.12)	Modbus diagnostics of last Tx data: Data byte 10	- (Read only)	Modbus RTU	U8	1	-	-
0x232F:013 (P585.13)	Modbus diagnostics of last Tx data: Data byte 11	- (Read only)	Modbus RTU	U8	1	-	-
0x232F:014 (P585.14)	Modbus diagnostics of last Tx data: Data byte 12	- (Read only)	Modbus RTU	U8	1	-	-
0x232F:015 (P585.15)	Modbus diagnostics of last Tx data: Data byte 13	- (Read only)	Modbus RTU	U8	1	-	-
0x232F:016 (P585.16)	Modbus diagnostics of last Tx data: Data byte 14	- (Read only)	Modbus RTU	U8	1	-	-
0x232F:017 (P585.17)	Modbus diagnostics of last Tx data: Data byte 15	- (Read only)	Modbus RTU	U8	1	-	-
0x2440	Initiate WLAN	No action/no error [0]	WLAN	U8	1	-	-
0x2441:001	WLAN settings: IP address	192.168.178.1	WLAN	U32	1	PE	-
0x2441:002	WLAN settings: Netmask	255.255.255.0	WLAN	U32	1	PE	-
0x2441:003	WLAN settings: Gateway	192.168.178.1	WLAN	U32	1	PE	-
0x2441:004	WLAN settings: DHCP	Enabled [1]	WLAN	U8	1	P	-
0x2441:005	WLAN settings: DHCP start address	0.0.0.0	WLAN	U32	1	PE	-
0x2441:006	WLAN settings: WLAN operation mode	Access point mode [0]	WLAN	U8	1	P	-
0x2441:007	WLAN settings: WLAN SSID	"i5"	WLAN	STRING[32]	1	P	-
0x2441:008	WLAN settings: WLAN password	"password"	WLAN	STRING[64]	1	P	-
0x2441:009	WLAN settings: WLAN security	WPA2 [1]	WLAN	U8	1	P	-
0x2441:010	WLAN settings: WLAN access	Enabled (WLAN on) [1]	WLAN	U8	1	P	-
0x2441:011	WLAN settings: WLAN channel	Channel 1 [1]	WLAN	U8	1	P	-
0x2441:012	WLAN settings: WLAN SSID broadcast	Activated [0]	WLAN	U8	1	P	-
0x2442:001	Active WLAN settings: Active IP address	- (Read only)	WLAN	U32	1	E	-
0x2442:002	Active WLAN settings: Active netmask	- (Read only)	WLAN	U32	1	E	-
0x2442:003	Active WLAN settings: Active gateway	- (Read only)	WLAN	U32	1	E	-
0x2442:004	Active WLAN settings: Active module mode	- (Read only)	WLAN	U8	1	-	-
0x2442:005	Active WLAN settings: MAC address	- (Read only)	WLAN	OCTET[6]	1	-	-
0x2448:001	WLAN status: Connection time	- (Read only)	WLAN	U32	1	-	-
0x2448:002	WLAN status: Number of connections	- (Read only)	WLAN	U16	1	-	-
0x2448:003	WLAN status: Rx frame counter	- (Read only)	WLAN	U16	1	-	-
0x2448:004	WLAN status: Error statistics	- (Read only)	WLAN	U16	1	-	-
0x2449	WLAN error	- (Read only)	WLAN	U16	1	-	-
0x24E5:001	Process data handling in case of error: Procedure	Keep last data [0]	general	U8	1	P	-
0x2540:001 (P208.01)	Mains settings: Rated mains voltage	230 Veff [0]	general	U8	1	PC	-
0x2540:002 (P208.02)	Mains settings: Undervoltage warning threshold	0 V *	general	U16	1	P	-
0x2540:003 (P208.03)	Mains settings: Undervoltage error threshold	x V (Read only)	general	U16	1	-	-
0x2540:004 (P208.04)	Mains settings: Undervoltage reset threshold	x V (Read only)	general	U16	1	-	-
0x2540:005 (P208.05)	Mains settings: Overvoltage warning threshold	0 V *	general	U16	1	P	-
0x2540:006 (P208.06)	Mains settings: Overvoltage error threshold	x V (Read only)	general	U16	1	-	-
0x2540:007 (P208.07)	Mains settings: Overvoltage reset threshold	x V (Read only)	general	U16	1	-	-
0x2541:001 (P706.01)	Brake energy management: Operating mode	Ramp function generator stop (RFGS) [1]	general	U8	1	P	-
0x2541:002 (P706.02)	Brake energy management: Active threshold	x V (Read only)	general	U16	1	P	-

* Default setting dependent on the model.

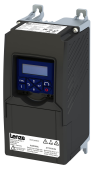

Appendix

Parameter attribute list

Address	Name	Default setting	Category	Data type	Factor	A	M
0x2541:003 (P706.03)	Brake energy management: Reduced threshold	0 V	general	U16	1	P	-
0x2541:004 (P706.04)	Brake energy management: Additional frequency	0.0 Hz	general	U16	10	P	-
0x2541:005 (P706.05)	Brake energy management: Deceleration override time	2.0 s	general	U16	10	P	-
0x2552:002 (P595.02)	Parameter access monitoring: Keep alive register	0	general	U16	1	K	-
0x2552:003 (P595.03)	Parameter access monitoring: Time-out time	10.0 s	general	U16	10	P	-
0x2552:004 (P595.04)	Parameter access monitoring: Reaction	No response [0]	general	U8	1	P	-
0x2552:005 (P595.05)	Parameter access monitoring: Action	No action [0]	general	U8	1	P	-
0x2552:006 (P595.06)	Parameter access monitoring: Parameter Access Monitoring-Status	- (Read only)	general	U16	1	O	-
0x2552:007 (P595.07)	Parameter access monitoring: WLAN reset time-out time	0 s	general	U16	1	P	-
0x2601:001 (P202.01)	Keypad setpoints: Frequency setpoint	20.0 Hz	general	U16	10	P	r
0x2601:002 (P202.02)	Keypad setpoints: Process controller setpoint	0.00 PID unit	general	I16	100	P	r
0x2601:003 (P202.03)	Keypad setpoints: Torque setpoint	100.0 %	general	I16	10	P	r
0x2602:001 (P708.01)	Manual control: Keypad setting	CTRL & F/R enable [1]	general	U8	1	P	-
0x2602:002 (P708.02)	Manual control: Keypad rotational direction	Forward [0]	general	U8	1	P	-
0x2602:003 (P708.03)	Manual control: Mode	Keypad full control off [0]	general	U8	1	-	-
0x261C:001 (P740.01)	Favorites settings: Parameter 1	0x2DDD0000	general	IDX	1	PH	-
0x261C:002 (P740.02)	Favorites settings: Parameter 2	0x60780000	general	IDX	1	PH	-
0x261C:003 (P740.03)	Favorites settings: Parameter 3	0x2D890000	general	IDX	1	PH	-
0x261C:004 (P740.04)	Favorites settings: Parameter 4	0x603F0000	general	IDX	1	PH	-
0x261C:005 (P740.05)	Favorites settings: Parameter 5	0x28240000	general	IDX	1	PH	-
0x261C:006 (P740.06)	Favorites settings: Parameter 6	0x28600100	general	IDX	1	PH	-
0x261C:007 (P740.07)	Favorites settings: Parameter 7	0x28380100	general	IDX	1	PH	-
0x261C:008 (P740.08)	Favorites settings: Parameter 8	0x28380300	general	IDX	1	PH	-
0x261C:009 (P740.09)	Favorites settings: Parameter 9	0x25400100	general	IDX	1	PH	-
0x261C:010 (P740.10)	Favorites settings: Parameter 10	0x29150000	general	IDX	1	PH	-
0x261C:011 (P740.11)	Favorites settings: Parameter 11	0x29160000	general	IDX	1	PH	-
0x261C:012 (P740.12)	Favorites settings: Parameter 12	0x29170000	general	IDX	1	PH	-
0x261C:013 (P740.13)	Favorites settings: Parameter 13	0x29180000	general	IDX	1	PH	-
0x261C:014 (P740.14)	Favorites settings: Parameter 14	0x2C000000	general	IDX	1	PH	-

* Default setting dependent on the model.

Appendix

Parameter attribute list



Address	Name	Default setting	Category	Data type	Factor	A	M
0x261C:015 (P740.15)	Favorites settings: Parameter 15	0x2B000000	general	IDX	1	PH	-
0x261C:016 (P740.16)	Favorites settings: Parameter 16	0x2B010100	general	IDX	1	PH	-
0x261C:017 (P740.17)	Favorites settings: Parameter 17	0x2B010200	general	IDX	1	PH	-
0x261C:018 (P740.18)	Favorites settings: Parameter 18	0x283A0000	general	IDX	1	PH	-
0x261C:019 (P740.19)	Favorites settings: Parameter 19	0x29390000	general	IDX	1	PH	-
0x261C:020 (P740.20)	Favorites settings: Parameter 20	0x2D430100	general	IDX	1	PH	-
0x261C:021 (P740.21)	Favorites settings: Parameter 21	0x2D4B0100	general	IDX	1	PH	-
0x261C:022 (P740.22)	Favorites settings: Parameter 22	0x2B120100	general	IDX	1	PH	-
0x261C:023 (P740.23)	Favorites settings: Parameter 23	0x60750000	general	IDX	1	PH	-
0x261C:024 (P740.24)	Favorites settings: Parameter 24	0x60730000	general	IDX	1	PH	-
0x261C:025 (P740.25)	Favorites settings: Parameter 25	0x26310100	general	IDX	1	PH	-
0x261C:026 (P740.26)	Favorites settings: Parameter 26	0x26310200	general	IDX	1	PH	-
0x261C:027 (P740.27)	Favorites settings: Parameter 27	0x26310300	general	IDX	1	PH	-
0x261C:028 (P740.28)	Favorites settings: Parameter 28	0x26310400	general	IDX	1	PH	-
0x261C:029 (P740.29)	Favorites settings: Parameter 29	0x26310500	general	IDX	1	PH	-
0x261C:030 (P740.30)	Favorites settings: Parameter 30	0x26310600	general	IDX	1	PH	-
0x261C:031 (P740.31)	Favorites settings: Parameter 31	0x26310700	general	IDX	1	PH	-
0x261C:032 (P740.32)	Favorites settings: Parameter 32	0x26310800	general	IDX	1	PH	-
0x261C:033 (P740.33)	Favorites settings: Parameter 33	0x26310900	general	IDX	1	PH	-
0x261C:034 (P740.34)	Favorites settings: Parameter 34	0x26310D00	general	IDX	1	PH	-
0x261C:035 (P740.35)	Favorites settings: Parameter 35	0x26311200	general	IDX	1	PH	-
0x261C:036 (P740.36)	Favorites settings: Parameter 36	0x26311300	general	IDX	1	PH	-
0x261C:037 (P740.37)	Favorites settings: Parameter 37	0x26311400	general	IDX	1	PH	-
0x261C:038 (P740.38)	Favorites settings: Parameter 38	0x26340100	general	IDX	1	PH	-
0x261C:039 (P740.39)	Favorites settings: Parameter 39	0x26340200	general	IDX	1	PH	-
0x261C:040 (P740.40)	Favorites settings: Parameter 40	0x26360100	general	IDX	1	PH	-
0x261C:041 (P740.41)	Favorites settings: Parameter 41	0x26360200	general	IDX	1	PH	-
0x261C:042 (P740.42)	Favorites settings: Parameter 42	0x26360300	general	IDX	1	PH	-
0x261C:043 (P740.43)	Favorites settings: Parameter 43	0x26390100	general	IDX	1	PH	-

* Default setting dependent on the model.

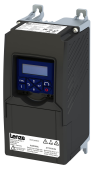

Appendix

Parameter attribute list

Address	Name	Default setting	Category	Data type	Factor	A	M
0x261C:044 (P740.44)	Favorites settings: Parameter 44	0x26390200	general	IDX	1	PH	-
0x261C:045 (P740.45)	Favorites settings: Parameter 45	0x26390300	general	IDX	1	PH	-
0x261C:046 (P740.46)	Favorites settings: Parameter 46	0x26390400	general	IDX	1	PH	-
0x261C:047 (P740.47)	Favorites settings: Parameter 47	0x29110100	general	IDX	1	PH	-
0x261C:048 (P740.48)	Favorites settings: Parameter 48	0x29110200	general	IDX	1	PH	-
0x261C:049 (P740.49)	Favorites settings: Parameter 49	0x29110300	general	IDX	1	PH	-
0x261C:050 (P740.50)	Favorites settings: Parameter 50	0x29110400	general	IDX	1	PH	-
0x2630:001 (P410.01)	Settings for digital inputs: Assertion level	HIGH active [1]	general	U8	1	P	-
0x2630:002 (P410.02)	Settings for digital inputs: Input function	Digital input [0]	general	U8	1	P	-
0x2631:001 (P400.01)	Function list: Enable inverter	Constant TRUE [1]	general	U8	1	PC	-
0x2631:002 (P400.02)	Function list: Run	Digital input 1 [11]	general	U8	1	PC	-
0x2631:003 (P400.03)	Function list: Activate quick stop	Not connected [0]	general	U8	1	PC	-
0x2631:004 (P400.04)	Function list: Reset fault	Digital input 2 [12]	general	U8	1	P	-
0x2631:005 (P400.05)	Function list: Activate DC braking	Not connected [0]	general	U8	1	P	-
0x2631:006 (P400.06)	Function list: Start forward (CW)	Not connected [0]	general	U8	1	PC	-
0x2631:007 (P400.07)	Function list: Start reverse (CCW)	Not connected [0]	general	U8	1	PC	-
0x2631:008 (P400.08)	Function list: Run forward (CW)	Not connected [0]	general	U8	1	PC	-
0x2631:009 (P400.09)	Function list: Run reverse (CCW)	Not connected [0]	general	U8	1	PC	-
0x2631:010 (P400.10)	Function list: Jog forward (CW)	Not connected [0]	general	U8	1	PC	-
0x2631:011 (P400.11)	Function list: Jog reverse (CCW)	Not connected [0]	general	U8	1	PC	-
0x2631:012 (P400.12)	Function list: Activate keypad control	Not connected [0]	general	U8	1	P	-
0x2631:013 (P400.13)	Function list: Reverse rotational direction	Digital input 3 [13]	general	U8	1	PC	-
0x2631:014 (P400.14)	Function list: Activate AI1 setpoint	Not connected [0]	general	U8	1	P	-
0x2631:015 (P400.15)	Function list: Activate AI2 setpoint	Not connected [0]	general	U8	1	P	-
0x2631:016 (P400.16)	Function list: Activate keypad setpoint	Not connected [0]	general	U8	1	P	-
0x2631:017 (P400.17)	Function list: Activate network setpoint	Not connected [0]	general	U8	1	P	-
0x2631:018 (P400.18)	Function list: Activate preset (bit 0)	Digital input 4 [14]	general	U8	1	P	-
0x2631:019 (P400.19)	Function list: Activate preset (bit 1)	Digital input 5 [15]	general	U8	1	P	-
0x2631:020 (P400.20)	Function list: Activate preset (bit 2)	Not connected [0]	general	U8	1	P	-

* Default setting dependent on the model.

Appendix

Parameter attribute list



Address	Name	Default setting	Category	Data type	Factor	A	M
0x2631:021 (P400.21)	Function list: Activate preset (bit 3)	Not connected [0]	general	U8	1	P	-
0x2631:023 (P400.23)	Function list: MOP setpoint up	Not connected [0]	general	U8	1	P	-
0x2631:024 (P400.24)	Function list: MOP setpoint down	Not connected [0]	general	U8	1	P	-
0x2631:025 (P400.25)	Function list: Activate MOP setpoint	Not connected [0]	general	U8	1	P	-
0x2631:026 (P400.26)	Function list: Activate segment setpoint (bit 0)	Not connected [0]	Sequencer	U8	1	P	-
0x2631:027 (P400.27)	Function list: Activate segment setpoint (bit 1)	Not connected [0]	Sequencer	U8	1	P	-
0x2631:028 (P400.28)	Function list: Activate segment setpoint (bit 2)	Not connected [0]	Sequencer	U8	1	P	-
0x2631:029 (P400.29)	Function list: Activate segment setpoint (bit 3)	Not connected [0]	Sequencer	U8	1	P	-
0x2631:030 (P400.30)	Function list: Run/abort sequence	Not connected [0]	Sequencer	U8	1	PC	-
0x2631:031 (P400.31)	Function list: Start sequence	Not connected [0]	Sequencer	U8	1	PC	-
0x2631:032 (P400.32)	Function list: Next sequence step	Not connected [0]	Sequencer	U8	1	PC	-
0x2631:033 (P400.33)	Function list: Pause sequence	Not connected [0]	Sequencer	U8	1	PC	-
0x2631:034 (P400.34)	Function list: Suspend sequence	Not connected [0]	Sequencer	U8	1	PC	-
0x2631:035 (P400.35)	Function list: Stop sequence	Not connected [0]	Sequencer	U8	1	PC	-
0x2631:036 (P400.36)	Function list: Abort sequence	Not connected [0]	Sequencer	U8	1	PC	-
0x2631:037 (P400.37)	Function list: Activate network control	Not connected [0]	general	U8	1	P	-
0x2631:039 (P400.39)	Function list: Activate ramp 2	Not connected [0]	general	U8	1	P	-
0x2631:040 (P400.40)	Function list: Load parameter set	Not connected [0]	general	U8	1	PC	-
0x2631:041 (P400.41)	Function list: Select parameter set (bit 0)	Not connected [0]	general	U8	1	PC	-
0x2631:042 (P400.42)	Function list: Select parameter set (bit 1)	Not connected [0]	general	U8	1	PC	-
0x2631:043 (P400.43)	Function list: Activate fault 1	Not connected [0]	general	U8	1	P	-
0x2631:044 (P400.44)	Function list: Activate fault 2	Not connected [0]	general	U8	1	P	-
0x2631:045 (P400.45)	Function list: Deactivate PID controller	Not connected [0]	general	U8	1	P	-
0x2631:046 (P400.46)	Function list: Set process controller output to 0	Not connected [0]	general	U8	1	P	-
0x2631:047 (P400.47)	Function list: Inhibit process controller I-component	Not connected [0]	general	U8	1	P	-
0x2631:048 (P400.48)	Function list: Activate PID influence ramp	Constant TRUE [1]	general	U8	1	P	-
0x2631:049 (P400.49)	Function list: Open holding brake	Not connected [0]	general	U8	1	PC	-
0x2631:050 (P400.50)	Function list: Select sequence (bit 0)	Not connected [0]	Sequencer	U8	1	PC	-
0x2631:051 (P400.51)	Function list: Select sequence (bit 1)	Not connected [0]	Sequencer	U8	1	PC	-

* Default setting dependent on the model.

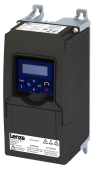

Appendix

Parameter attribute list

Address	Name	Default setting	Category	Data type	Factor	A	M
0x2631:052 (P400.52)	Function list: Select sequence (bit 2)	Not connected [0]	Sequencer	U8	1	PC	-
0x2631:053 (P400.53)	Function list: Select sequence (bit 3)	Not connected [0]	Sequencer	U8	1	PC	-
0x2631:054 (P400.54)	Function list: Position counter reset	Not connected [0]	general	U8	1	P	-
0x2631:055 (P400.55)	Function list: Activate UPS operation	Not connected [0]	general	U8	1	P	-
0x2631:056 (P400.56)	Function list: Assist pump 1	Not connected [0]		U8	1	P	-
0x2631:057 (P400.57)	Function list: Assist pump 2	Not connected [0]		U8	1	P	-
0x2631:058 (P400.58)	Function list: Reset operating time	Not connected [0]		U8	1	P	-
0x2632:001 (P411.01)	Inversion of digital inputs: Digital input 1	Not inverted [0]	general	U8	1	P	-
0x2632:002 (P411.02)	Inversion of digital inputs: Digital input 2	Not inverted [0]	general	U8	1	P	-
0x2632:003 (P411.03)	Inversion of digital inputs: Digital input 3	Not inverted [0]	general	U8	1	P	-
0x2632:004 (P411.04)	Inversion of digital inputs: Digital input 4	Not inverted [0]	general	U8	1	P	-
0x2632:005 (P411.05)	Inversion of digital inputs: Digital input 5	Not inverted [0]	general	U8	1	P	-
0x2632:006 (P411.06)	Inversion of digital inputs: Digital input 6	Not inverted [0]	Appl. I/O	U8	1	P	-
0x2632:007 (P411.07)	Inversion of digital inputs: Digital input 7	Not inverted [0]	Appl. I/O	U8	1	P	-
0x2633:001	Digital input debounce time: Digital input 1	1 ms	general	U8	1	P	-
0x2633:002	Digital input debounce time: Digital input 2	1 ms	general	U8	1	P	-
0x2633:003	Digital input debounce time: Digital input 3	1 ms	general	U8	1	P	-
0x2633:004	Digital input debounce time: Digital input 4	1 ms	general	U8	1	P	-
0x2633:005	Digital input debounce time: Digital input 5	1 ms	general	U8	1	P	-
0x2633:006	Digital input debounce time: Digital input 6	1 ms	Appl. I/O	U8	1	P	-
0x2633:007	Digital input debounce time: Digital input 7	1 ms	Appl. I/O	U8	1	P	-
0x2634:001 (P420.01)	Digital outputs function: Relay	Ready for operation [51]	general	U8	1	P	-
0x2634:002 (P420.02)	Digital outputs function: Digital output 1	Release holding brake [115]	general	U8	1	P	-
0x2634:010 (P420.10)	Digital outputs function: NetWordOUT1 - bit 0	Ready for operation [51]	general	U8	1	P	-
0x2634:011 (P420.11)	Digital outputs function: NetWordOUT1 - bit 1	Not connected [0]	general	U8	1	P	-
0x2634:012 (P420.12)	Digital outputs function: NetWordOUT1 - bit 2	Operation enabled [52]	general	U8	1	P	-
0x2634:013 (P420.13)	Digital outputs function: NetWordOUT1 - bit 3	Fault active [56]	general	U8	1	P	-
0x2634:014 (P420.14)	Digital outputs function: NetWordOUT1 - bit 4	Not connected [0]	general	U8	1	P	-
0x2634:015 (P420.15)	Digital outputs function: NetWordOUT1 - bit 5	Quick stop active [54]	general	U8	1	P	-
0x2634:016 (P420.16)	Digital outputs function: NetWordOUT1 - bit 6	Running [50]	general	U8	1	P	-
0x2634:017 (P420.17)	Digital outputs function: NetWordOUT1 - bit 7	Device warning active [58]	general	U8	1	P	-
0x2634:018 (P420.18)	Digital outputs function: NetWordOUT1 - bit 8	Not connected [0]	general	U8	1	P	-
0x2634:019 (P420.19)	Digital outputs function: NetWordOUT1 - bit 9	Not connected [0]	general	U8	1	P	-

* Default setting dependent on the model.

Appendix

Parameter attribute list



Address	Name	Default setting	Category	Data type	Factor	A	M
0x2634:020 (P420.20)	Digital outputs function: NetWordOUT1 - bit 10	Setpoint speed reached [72]	general	U8	1	P	-
0x2634:021 (P420.21)	Digital outputs function: NetWordOUT1 - bit 11	Current limit reached [78]	general	U8	1	P	-
0x2634:022 (P420.22)	Digital outputs function: NetWordOUT1 - bit 12	Actual speed = 0 [71]	general	U8	1	P	-
0x2634:023 (P420.23)	Digital outputs function: NetWordOUT1 - bit 13	Rotational direction reversed [69]	general	U8	1	P	-
0x2634:024 (P420.24)	Digital outputs function: NetWordOUT1 - bit 14	Release holding brake [115]	general	U8	1	P	-
0x2634:025 (P420.25)	Digital outputs function: NetWordOUT1 - bit 15	Inverter disabled (safety) [55]	general	U8	1	P	-
0x2635:001 (P421.01)	Inversion of digital outputs: Relay	Not inverted [0]	general	U8	1	P	-
0x2635:002 (P421.02)	Inversion of digital outputs: Digital output 1	Not inverted [0]	general	U8	1	P	-
0x2635:010	Inversion of digital outputs: NetWordOUT1.00	Not inverted [0]	general	U8	1	P	-
0x2635:011	Inversion of digital outputs: NetWordOUT1.01	Not inverted [0]	general	U8	1	P	-
0x2635:012	Inversion of digital outputs: NetWordOUT1.02	Not inverted [0]	general	U8	1	P	-
0x2635:013	Inversion of digital outputs: NetWordOUT1.03	Not inverted [0]	general	U8	1	P	-
0x2635:014	Inversion of digital outputs: NetWordOUT1.04	Not inverted [0]	general	U8	1	P	-
0x2635:015	Inversion of digital outputs: NetWordOUT1.05	Not inverted [0]	general	U8	1	P	-
0x2635:016	Inversion of digital outputs: NetWordOUT1.06	Not inverted [0]	general	U8	1	P	-
0x2635:017	Inversion of digital outputs: NetWordOUT1.07	Not inverted [0]	general	U8	1	P	-
0x2635:018	Inversion of digital outputs: NetWordOUT1.08	Not inverted [0]	general	U8	1	P	-
0x2635:019	Inversion of digital outputs: NetWordOUT1.09	Not inverted [0]	general	U8	1	P	-
0x2635:020	Inversion of digital outputs: NetWordOUT1.10	Not inverted [0]	general	U8	1	P	-
0x2635:021	Inversion of digital outputs: NetWordOUT1.11	Not inverted [0]	general	U8	1	P	-
0x2635:022	Inversion of digital outputs: NetWordOUT1.12	Not inverted [0]	general	U8	1	P	-
0x2635:023	Inversion of digital outputs: NetWordOUT1.13	Not inverted [0]	general	U8	1	P	-
0x2635:024	Inversion of digital outputs: NetWordOUT1.14	Not inverted [0]	general	U8	1	P	-
0x2635:025	Inversion of digital outputs: NetWordOUT1.15	Not inverted [0]	general	U8	1	P	-
0x2636:001 (P430.01)	Analog input 1: Input range	0 ... 10 VDC [0]	general	U8	1	P	-
0x2636:002 (P430.02)	Analog input 1: Min frequency value	0.0 Hz	general	I16	10	P	-
0x2636:003 (P430.03)	Analog input 1: Max frequency value	Device for 50-Hz mains: 50.0 Hz Device for 60-Hz mains: 60.0 Hz	general	I16	10	P	-
0x2636:004 (P430.04)	Analog input 1: Min PID value	0.00 PID unit	general	I16	100	P	-
0x2636:005 (P430.05)	Analog input 1: Max PID value	100.00 PID unit	general	I16	100	P	-
0x2636:006 (P430.06)	Analog input 1: Filter time	10 ms	general	U16	1	P	-
0x2636:007 (P430.07)	Analog input 1: Dead band	0.0 %	general	U16	10	P	-
0x2636:008 (P430.08)	Analog input 1: Monitoring threshold	0.0 %	general	I16	10	P	-
0x2636:009 (P430.09)	Analog input 1: Monitoring condition	Input value < trigger threshold [0]	general	U8	1	P	-
0x2636:010 (P430.10)	Analog input 1: Error response	Fault [3]	general	U8	1	P	-
0x2636:011 (P430.11)	Analog input 1: Min torque value	0.0 %	general	I16	10	P	-
0x2636:012 (P430.12)	Analog input 1: Max torque value	100.0 %	general	I16	10	P	-

* Default setting dependent on the model.

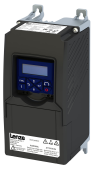

Appendix

Parameter attribute list

Address	Name	Default setting	Category	Data type	Factor	A	M
0x2637:001 (P431.01)	Analog input 2: Input range	0 ... 10 VDC [0]	general	U8	1	P	-
0x2637:002 (P431.02)	Analog input 2: Min frequency value	0.0 Hz	general	I16	10	P	-
0x2637:003 (P431.03)	Analog input 2: Max frequency value	Device for 50-Hz mains: 50.0 Hz Device for 60-Hz mains: 60.0 Hz	general	I16	10	P	-
0x2637:004 (P431.04)	Analog input 2: Min PID value	0.00 PID unit	general	I16	100	P	-
0x2637:005 (P431.05)	Analog input 2: Max PID value	100.00 PID unit	general	I16	100	P	-
0x2637:006 (P431.06)	Analog input 2: Filter time	10 ms	general	U16	1	P	-
0x2637:007 (P431.07)	Analog input 2: Dead band	0.0 %	general	U16	10	P	-
0x2637:008 (P431.08)	Analog input 2: Monitoring threshold	0.0 %	general	I16	10	P	-
0x2637:009 (P431.09)	Analog input 2: Monitoring condition	Input value < trigger threshold [0]	general	U8	1	P	-
0x2637:010 (P431.10)	Analog input 2: Error response	Fault [3]	general	U8	1	P	-
0x2637:011 (P431.11)	Analog input 2: Min torque value	0.0 %	general	I16	10	P	-
0x2637:012 (P431.12)	Analog input 2: Max torque value	100.0 %	general	I16	10	P	-
0x2639:001 (P440.01)	Analog output 1: Output range	0 ... 10 VDC [1]	general	U8	1	P	-
0x2639:002 (P440.02)	Analog output 1: Function	Output frequency [1]	general	U8	1	P	-
0x2639:003 (P440.03)	Analog output 1: Min. signal	0	general	I32	1	P	-
0x2639:004 (P440.04)	Analog output 1: Max. signal	1000	general	I32	1	P	-
0x2820:001 (P712.01)	Holding brake control: Brake mode	Off [2]	general	U8	1	P	r
0x2820:002 (P712.02)	Holding brake control: Brake closing time	100 ms	general	U16	1	P	-
0x2820:003 (P712.03)	Holding brake control: Brake opening time	100 ms	general	U16	1	P	-
0x2820:007 (P712.07)	Holding brake control: Brake closing threshold	0.2 Hz	general	U16	10	P	-
0x2820:008 (P712.08)	Holding brake control: Brake holding load	0.0 %	general	I16	10	PC	-
0x2820:012 (P712.12)	Holding brake control: Closing threshold delay	0 ms	general	U16	1	P	-
0x2820:013 (P712.13)	Holding brake control: Holding load ramptime	0 ms	general	U16	1	PC	-
0x2820:015 (P712.15)	Holding brake control: Brake status	- (Read only)	general	U8	1	O	-
0x2822:004 (P327.04)	Identify motor data (energized)	0	general	U8	1	-	-
0x2822:005 (P327.05)	Calibrate motor data (non-energized)	0	general	U8	1	-	-
0x2822:019	Calculate I _{max} controller parameter	0	general	U8	1	-	-
0x2824 (P200.00)	Control selection	Flexible I/O configuration [0]	general	U8	1	P	-
0x2826	Time-out for error response	6.0 s	general	U16	10	P	-

* Default setting dependent on the model.

Appendix

Parameter attribute list



Address	Name	Default setting	Category	Data type	Factor	A	M
0x2827 (P198.00)	Currently loaded parameter settings	- (Read only)	general	U8	1	O	-
0x2829 (P732.00)	Automatic storage in the memory module	Inhibit [0]	general	U8	1	P	-
0x282A:001 (P126.01)	Status words: Cause of disable	- (Read only)	general	U32	1	O	-
0x282A:002 (P126.02)	Status words: Cause of quick stop	- (Read only)	general	U16	1	O	-
0x282A:003 (P126.03)	Status words: Cause of stop	- (Read only)	general	U16	1	O	-
0x282A:004	Status words: Extended status word	- (Read only)	general	U16	1	O	t
0x282A:005 (P126.05)	Status words: Device status	- (Read only)	general	U8	1	O	t
0x282B:001 (P125.01)	Inverter diagnostics: Active control source	- (Read only)	general	U8	1	O	t
0x282B:002 (P125.02)	Inverter diagnostics: Active setpoint source	- (Read only)	general	U8	1	O	t
0x282B:003 (P125.03)	Inverter diagnostics: Keypad LCD status	- (Read only)	general	U8	1	O	-
0x282B:004 (P125.04)	Inverter diagnostics: Active drive mode	- (Read only)	general	U8	1	O	t
0x282B:005 (P125.05)	Inverter diagnostics: Most recently used control register	- (Read only)	general	U32	1	H	-
0x282B:006 (P125.06)	Inverter diagnostics: Most recently used setpoint register	- (Read only)	general	U32	1	H	-
0x282B:007	Inverter diagnostics: Default frequency setpoint	x.x Hz (Read only)	general	I16	10	-	-
0x282B:008	Inverter diagnostics: Preset frequency setpoint	x.x Hz (Read only)	general	I16	10	-	-
0x282B:009	Inverter diagnostics: Actual frequency setpoint	x.x Hz (Read only)	general	I16	10	O	-
0x282B:010	Inverter diagnostics: Default PID setpoint	x.xx PID unit (Read only)	general	I16	100	-	-
0x282B:011	Inverter diagnostics: Preset PID setpoint	x.xx PID unit (Read only)	general	I16	100	-	-
0x282B:012	Inverter diagnostics: Default torque setpoint	x.x % (Read only)	general	I16	10	-	-
0x282B:013	Inverter diagnostics: Preset torque setpoint	x.x % (Read only)	general	I16	10	-	-
0x2831	Inverter-Statuswort	- (Read only)	MCTRL	U16	1	O	t
0x2833	Inverter status word 2	- (Read only)	MCTRL	U16	1	O	t
0x2838:001 (P203.01)	Start/stop configuration: Start method	Normal [0]	MCTRL	U8	1	PC	-
0x2838:002 (P203.02)	Start/stop configuration: Start at power-up	Off [0]	general	U8	1	P	-
0x2838:003 (P203.03)	Start/stop configuration: Stop method	Standard ramp [1]	general	U8	1	P	-
0x2839:002 (P760.02)	Fault configuration: Restart delay	3.0 s	general	U16	10	P	-
0x2839:003 (P760.03)	Fault configuration: Number of restart attempts	5	general	U8	1	P	-
0x2839:004 (P760.04)	Fault configuration: Trouble counter reset time	40.0 s	general	U16	10	P	-
0x2839:005 (P760.05)	Fault configuration: Trouble counter	- (Read only)	general	U8	1	O	-
0x2839:006 (P760.06)	Fault configuration: Fault handling in case of state change	Reset fault [0]	general	U8	1	P	-
0x283A (P304.00)	Limitation of rotation	Both rotational directions [1]	general	U8	1	P	-
0x2857:001	CANopen monitoring: RPDO1-Timeout	Fault [3]	CANopen	U8	1	P	-
0x2857:002	CANopen monitoring: RPDO2-Timeout	Fault [3]	CANopen	U8	1	P	-
0x2857:003	CANopen monitoring: RPDO3-Timeout	Fault [3]	CANopen	U8	1	P	-
0x2857:005	CANopen monitoring: Heartbeat-Timeout Consumer 1	Fault [3]	CANopen	U8	1	P	-

* Default setting dependent on the model.

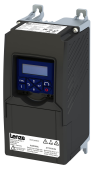

Appendix

Parameter attribute list

Address	Name	Default setting	Category	Data type	Factor	A	M
0x2857:006	CANopen monitoring: Heartbeat-Timeout Consumer 2	Fault [3]	CANopen	U8	1	P	-
0x2857:007	CANopen monitoring: Heartbeat-Timeout Consumer 3	Fault [3]	CANopen	U8	1	P	-
0x2857:008	CANopen monitoring: Heartbeat-Timeout Consumer 4	Fault [3]	CANopen	U8	1	P	-
0x2857:010	CANopen monitoring: "Bus-off" state change	Trouble [2]	CANopen	U8	1	P	-
0x2857:011	CANopen monitoring: Warning	Warning [1]	CANopen	U8	1	P	-
0x2858:001 (P515.01)	Modbus monitoring: Response to time-out	Fault [3]	Modbus RTU	U8	1	P	-
0x2858:002 (P515.02)	Modbus monitoring: Time-out time	2.0 s	Modbus RTU	U16	10	P	-
0x285C:001	Alarm suppression: Entry 1	0x00000000		U32	1	PH	-
0x285C:002	Alarm suppression: Entry 2	0x00000000		U32	1	PH	-
0x285C:003	Alarm suppression: Entry 3	0x00000000		U32	1	PH	-
0x285C:004	Alarm suppression: Entry 4	0x00000000		U32	1	PH	-
0x285C:005	Alarm suppression: Entry 5	0x00000000		U32	1	PH	-
0x285C:006	Alarm suppression: Entry 6	0x00000000		U32	1	PH	-
0x285C:007	Alarm suppression: Entry 7	0x00000000		U32	1	PH	-
0x285C:008	Alarm suppression: Entry 8	0x00000000		U32	1	PH	-
0x285C:009	Alarm suppression: Entry 9	0x00000000		U32	1	PH	-
0x285C:010	Alarm suppression: Entry 10	0x00000000		U32	1	PH	-
0x2860:001 (P201.01)	Frequency control: Default setpoint source	Analog input 1 [2]	general	U8	1	P	-
0x2860:002 (P201.02)	PID control: Default setpoint source	Keypad [1]	general	U8	1	P	-
0x2860:003 (P201.03)	Torque control: Default setpoint source	Analog input 1 [2]	general	U8	1	P	-
0x2862 (P701.00)	Keypad setpoint increment	1	general	U16	1	P	-
0x2863 (P705.00)	Keypad language selection	English [1]	general	U8	1	P	-
0x2864 (P703.00)	Keypad status display	0x00000000	general	IDX	1	PH	-
0x2865:001 (P709.01)	Keypad display setup: User unit MS velocity mode		general	STRING[6]	1	P	-
0x2865:002 (P709.02)	Keypad display setup: User unit PID control		general	STRING[6]	1	P	-
0x2900:001 (P332.01)	Speed controller settings: Gain	0.00193 Nm/rpm *	MCTRL	U32	100000	P	-
0x2900:002 (P332.02)	Speed controller settings: Reset time	80.0 ms *	MCTRL	U16	10	P	-
0x2904	Actual speed filter time	2.0 ms	MCTRL	U16	10	P	-
0x2910:001 (P335.01)	Inertia settings: Motor moment of inertia	3.70 kg cm² *	MCTRL	U32	100	P	-
0x2910:002 (P335.02)	Inertia settings: Scaled load inertia	0.00 kg cm²	MCTRL	U32	100	P	-
0x2910:003	Inertia settings: Coupling	With backlash [2]	MCTRL	U8	1	P	-
0x2911:001 (P450.01)	Frequency setpoint presets: Preset 1	20.0 Hz	general	U16	10	OP	-
0x2911:002 (P450.02)	Frequency setpoint presets: Preset 2	40.0 Hz	general	U16	10	OP	-
0x2911:003 (P450.03)	Frequency setpoint presets: Preset 3	Device for 50-Hz mains: 50.0 Hz Device for 60-Hz mains: 60.0 Hz	general	U16	10	OP	-
0x2911:004 (P450.04)	Frequency setpoint presets: Preset 4	0.0 Hz	general	U16	10	OP	-

* Default setting dependent on the model.

Appendix

Parameter attribute list



Address	Name	Default setting	Category	Data type	Factor	A	M
0x2911:005 (P450.05)	Frequency setpoint presets: Preset 5	0.0 Hz	general	U16	10	OP	-
0x2911:006 (P450.06)	Frequency setpoint presets: Preset 6	0.0 Hz	general	U16	10	OP	-
0x2911:007 (P450.07)	Frequency setpoint presets: Preset 7	0.0 Hz	general	U16	10	OP	-
0x2911:008 (P450.08)	Frequency setpoint presets: Preset 8	0.0 Hz	general	U16	10	OP	-
0x2911:009 (P450.09)	Frequency setpoint presets: Preset 9	0.0 Hz	general	U16	10	OP	-
0x2911:010 (P450.10)	Frequency setpoint presets: Preset 10	0.0 Hz	general	U16	10	OP	-
0x2911:011 (P450.11)	Frequency setpoint presets: Preset 11	0.0 Hz	general	U16	10	OP	-
0x2911:012 (P450.12)	Frequency setpoint presets: Preset 12	0.0 Hz	general	U16	10	OP	-
0x2911:013 (P450.13)	Frequency setpoint presets: Preset 13	0.0 Hz	general	U16	10	OP	-
0x2911:014 (P450.14)	Frequency setpoint presets: Preset 14	0.0 Hz	general	U16	10	OP	-
0x2911:015 (P450.15)	Frequency setpoint presets: Preset 15	0.0 Hz	general	U16	10	OP	-
0x2912:001 (P452.01)	Torque setpoint presets: Preset 1	100.0 %	general	I16	10	OP	-
0x2912:002 (P452.02)	Torque setpoint presets: Preset 2	100.0 %	general	I16	10	OP	-
0x2912:003 (P452.03)	Torque setpoint presets: Preset 3	100.0 %	general	I16	10	OP	-
0x2912:004 (P452.04)	Torque setpoint presets: Preset 4	100.0 %	general	I16	10	OP	-
0x2912:005 (P452.05)	Torque setpoint presets: Preset 5	100.0 %	general	I16	10	OP	-
0x2912:006 (P452.06)	Torque setpoint presets: Preset 6	100.0 %	general	I16	10	OP	-
0x2912:007 (P452.07)	Torque setpoint presets: Preset 7	100.0 %	general	I16	10	OP	-
0x2912:008 (P452.08)	Torque setpoint presets: Preset 8	100.0 %	general	I16	10	OP	-
0x2915 (P210.00)	Minimum frequency	0.0 Hz	general	U16	10	P	-
0x2916 (P211.00)	Maximum frequency	Device for 50-Hz mains: 50.0 Hz Device for 60-Hz mains: 60.0 Hz	general	U16	10	P	-
0x2917 (P220.00)	Acceleration time 1	5.0 s	general	U16	10	P	rt
0x2918 (P221.00)	Deceleration time 1	5.0 s	general	U16	10	P	rt
0x2919 (P222.00)	Acceleration time 2	5.0 s	general	U16	10	P	-
0x291A (P223.00)	Deceleration time 2	5.0 s	general	U16	10	P	-
0x291B (P224.00)	Auto-changeover threshold of ramp 2	0.0 Hz	general	U16	10	P	-
0x291C (P225.00)	Quick stop deceleration time	1.0 s	general	U16	10	P	-
0x291E:001 (P226.01)	S-Ramp characteristic: Smoothing factor	0.0 %	general	U16	10	P	r

* Default setting dependent on the model.

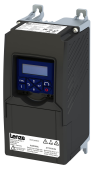

Appendix

Parameter attribute list

Address	Name	Default setting	Category	Data type	Factor	A	M
0x291E:003 (P226.03)	S-Ramp characteristic: Stop threshold	10.0 %	general	U16	10	P	-
0x291F:001 (P317.01)	Skip frequencies: Skip frequency 1	0.0 Hz	general	U16	10	P	-
0x291F:002 (P317.02)	Skip frequencies: Skip bandwidth 1	0.0 Hz	general	U8	10	P	-
0x291F:003 (P317.03)	Skip frequencies: Skip frequency 2	0.0 Hz	general	U16	10	P	-
0x291F:004 (P317.04)	Skip frequencies: Skip bandwidth 2	0.0 Hz	general	U8	10	P	-
0x291F:005 (P317.05)	Skip frequencies: Skip frequency 3	0.0 Hz	general	U16	10	P	-
0x291F:006 (P317.06)	Skip frequencies: Skip bandwidth 3	0.0 Hz	general	U8	10	P	-
0x291F:016	Skip frequencies: Status	- (Read only)	general	U16	1	O	-
0x291F:032	Skip frequencies: Input frequency	x.xx Hz (Read only)	general	I32	100	O	-
0x291F:033	Skip frequencies: Output frequency	x.xx Hz (Read only)	general	I32	100	O	-
0x2939 (P305.00)	Switching frequency	0 *	general	U8	1	P	-
0x293A (P116.00)	Actual switching frequency	- (Read only)	general	U8	1	O	t
0x2942:001 (P334.01)	Current controller parameters: Gain	42.55 V/A *	MCTRL	U32	100	P	-
0x2942:002 (P334.02)	Current controller parameters: Reset time	4.50 ms *	MCTRL	U32	100	P	-
0x2942:004	Current controller parameters: d-axis gain	26.00 V/A *	MCTRL	U32	100	P	-
0x2942:005	Current controller parameters: d-axis reset time	3.00 ms *	MCTRL	U32	100	P	-
0x2942:006	Current controller parameters: q-axis gain	26.00 V/A *	MCTRL	U32	100	P	-
0x2942:007	Current controller parameters: q-axis reset time	3.00 ms *	MCTRL	U32	100	P	-
0x2946:001 (P340.01)	Speed limitation: Upper speed limit	0 vel. unit	general	I32	480000 / 214748 3647	P	r
0x2946:002 (P340.02)	Speed limitation: Lower speed limit	0 vel. unit	general	I32	480000 / 214748 3647	P	r
0x2946:003 (P340.03)	Speed limitation: Upper speed limit source	Maximum frequency [0]	general	U8	1	P	-
0x2946:004 (P340.04)	Speed limitation: Lower speed limit source	(-) Maximum frequency [0]	general	U8	1	P	-
0x2946:005 (P340.05)	Speed limitation: Upper frequency limit	Device for 50-Hz mains: 50.0 Hz Device for 60-Hz mains: 60.0 Hz	general	I16	10	P	-
0x2946:006 (P340.06)	Speed limitation: Lower frequency limit	Device for 50-Hz mains: -50.0 Hz Device for 60-Hz mains: -60.0 Hz	general	I16	10	P	-
0x2946:007 (P340.07)	Speed limitation: Actual upper speed limit	x.x Hz (Read only)	general	I16	10	-	-
0x2946:008 (P340.08)	Speed limitation: Actual lower speed limit	x.x Hz (Read only)	general	I16	10	-	-
0x2947:001 ... 0x2947:017	Inverter characteristic: Value y1 ... Value y17	0.00 V *	MCTRL	U16	100	P	-
0x2948:001	Torque setpoint: Actual torque setpoint	x.x % (Read only)	general	I16	10	O	-
0x2948:002 (P336.02)	Torque setpoint: ramp time	1.0 s	general	U16	10	P	-

* Default setting dependent on the model.

Appendix

Parameter attribute list



Address	Name	Default setting	Category	Data type	Factor	A	M
0x2949:001 (P337.01)	Torque limit source selection: Positive torque limit source	Max torque [0]	general	U8	1	P	-
0x2949:002 (P337.02)	Torque limit source selection: Negative torque limit source	(-) Max torque [0]	general	U8	1	P	-
0x2949:003 (P337.03)	Torque limit source selection: Actual positive torque limit	x.x % (Read only)	general	I16	10	O	-
0x2949:004 (P337.04)	Torque limit source selection: Actual negative torque limit	x.x % (Read only)	general	I16	10	O	-
0x29C0:001	Field controller settings: Gain	59.68 A/Vs *	MCTRL	U32	100	P	-
0x29C0:002	Field controller settings: Reset time	45.5 ms *	MCTRL	U16	10	P	-
0x29E0:001	Field weakening controller settings: Gain (ASM)	0.000 Vs/V *	MCTRL	U32	1000	P	-
0x29E0:002	Field weakening controller settings: Reset time (ASM)	1478.3 ms *	MCTRL	U32	10	P	-
0x29E0:003	Field weakening controller settings: Reset time (PSM)	800.0 ms *	MCTRL	U32	10	P	-
0x29E1	Field weakening controller Field limitation	100.00 %	MCTRL	U16	100	P	r
0x29E2	DC-bus filter time	25.0 ms	MCTRL	U16	10	P	-
0x29E3	Motor voltage filter time	25.0 ms	MCTRL	U16	10	P	-
0x29E4 (P354.00)	Voltage reserve range	5 %	MCTRL	U8	1	P	-
0x2B00 (P302.00)	V/f characteristic shape	Linear [0]	MCTRL	U8	1	PC	-
0x2B01:001 (P303.01)	V/f shape data: Base voltage	230 V *	MCTRL	U16	1	P	-
0x2B01:002 (P303.02)	V/f shape data: Base frequency	Device for 50-Hz mains: 50 Hz Device for 60-Hz mains: 60 Hz *	MCTRL	U16	1	P	-
0x2B01:003 (P303.03)	V/f shape data: Midpoint voltage	0 V	MCTRL	U16	1	P	-
0x2B01:004 (P303.04)	V/f shape data: Midpoint frequency	0 Hz	MCTRL	U16	1	P	-
0x2B02:001	Frequency grid points (x) user V/f characteristic: x1 = f01	0 Hz		I16	1	P	-
0x2B02:002	Frequency grid points (x) user V/f characteristic: x2 = f02	0 Hz		I16	1	P	-
0x2B02:003	Frequency grid points (x) user V/f characteristic: x3 = f03	0 Hz		I16	1	P	-
0x2B02:004	Frequency grid points (x) user V/f characteristic: x4 = f04	0 Hz		I16	1	P	-
0x2B02:005	Frequency grid points (x) user V/f characteristic: x5 = f05	0 Hz		I16	1	P	-
0x2B02:006	Frequency grid points (x) user V/f characteristic: x6 = f06	0 Hz		I16	1	P	-
0x2B02:007	Frequency grid points (x) user V/f characteristic: x7 = f07	0 Hz		I16	1	P	-
0x2B02:008	Frequency grid points (x) user V/f characteristic: x8 = f08	0 Hz		I16	1	P	-
0x2B02:009	Frequency grid points (x) user V/f characteristic: x9 = f09	0 Hz		I16	1	P	-
0x2B02:010	Frequency grid points (x) user V/f characteristic: x10 = f10	0 Hz		I16	1	P	-
0x2B02:011	Frequency grid points (x) user V/f characteristic: x11 = f11	0 Hz		I16	1	P	-
0x2B03:001	Voltage grid points (y) user V/f characteristic: y1 = U01 (x = f01)	0.00 V		I32	100	P	-
0x2B03:002	Voltage grid points (y) user V/f characteristic: y2 = U02 (x = f02)	0.00 V		I32	100	P	-

* Default setting dependent on the model.

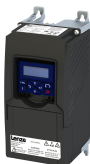

Appendix

Parameter attribute list

Address	Name	Default setting	Category	Data type	Factor	A	M
0x2B03:003	Voltage grid points (y) user V/f characteristic: y3 = U03 (x = f03)	0.00 V		I32	100	P	-
0x2B03:004	Voltage grid points (y) user V/f characteristic: y4 = U04 (x = f04)	0.00 V		I32	100	P	-
0x2B03:005	Voltage grid points (y) user V/f characteristic: y5 = U05 (x = f05)	0.00 V		I32	100	P	-
0x2B03:006	Voltage grid points (y) user V/f characteristic: y6 = U06 (x = f06)	0.00 V		I32	100	P	-
0x2B03:007	Voltage grid points (y) user V/f characteristic: y7 = U07 (x = f07)	0.00 V		I32	100	P	-
0x2B03:008	Voltage grid points (y) user V/f characteristic: y8 = U08 (x = f08)	0.00 V		I32	100	P	-
0x2B03:009	Voltage grid points (y) user V/f characteristic: y9 = U09 (x = f09)	0.00 V		I32	100	P	-
0x2B03:010	Voltage grid points (y) user V/f characteristic: y10 = U10 (x = f10)	0.00 V		I32	100	P	-
0x2B03:011	Voltage grid points (y) user V/f characteristic: y11 = U11 (x = f11)	0.00 V		I32	100	P	-
0x2B08:001 (P333.01)	V/f I _{max} controller: Gain	0.284 Hz/A *	MCTRL	U32	1000	P	-
0x2B08:002 (P333.02)	V/f I _{max} controller: Reset time	2.3 ms *	MCTRL	U32	10	P	-
0x2B09:001 (P315.01)	Slip compensation: Gain	100.00 %	MCTRL	I16	100	P	-
0x2B09:002 (P315.02)	Slip compensation: Filter time	100 ms	MCTRL	U16	1	P	-
0x2B0A:001 (P318.01)	Oscillation damping: Gain	150 %	MCTRL	I16	1	P	-
0x2B0A:002 (P318.02)	Oscillation damping: Filter time	30 ms	MCTRL	U16	1	P	-
0x2B0B	Frequency setpoint	x.x Hz (Read only)	general	I16	10	O	t
0x2B0C (P319.00)	Override field weakening	0.0 Hz	MCTRL	I16	10	P	-
0x2B0C (P319.00)	Override field weakening	-40.0 Hz	MCTRL	I16	10	P	-
0x2B0D:001 (P330.01)	VFC-ECO: Minimum voltage	20 %	MCTRL	I16	1	P	-
0x2B0D:006 (P330.06)	VFC-ECO: Cos phi actual value	- (Read only)	MCTRL	I16	100	-	t
0x2B0E (P102.00)	Frequency setpoint	x.x Hz (Read only)	general	I16	10	O	t
0x2B0F	Output frequency motor	x.x Hz (Read only)	MCTRL	I16	10	O	t
0x2B10:001	V/f torque limitation: Gain	0.00 %	MCTRL	U16	100	P	-
0x2B12:001 (P316.01)	V/f voltage boost: Fixed boost	2.5 % *	MCTRL	U8	10	P	-
0x2B12:002 (P316.02)	V/f voltage boost: Boost at acceleration	0.0 %	general	U8	10	P	-
0x2B13:001	Additive voltage impression: Enable Function	Disable [0]	general	U8	1	P	-
0x2B13:002	Additive voltage impression: Setpoint source	Analog input 1 [1]	general	U8	1	P	-
0x2B13:003	Additive voltage impression: Actual voltage	x V (Read only)	general	I16	1	O	-
0x2B13:004	Additive voltage impression: Ramp time	0.0 s	general	U16	10	P	-
0x2B40:001	Gain	0.2686 Hz/A *	MCTRL	U32	10000	P	-
0x2B40:002	Reset time	2.3 ms *	MCTRL	U32	10	P	-
0x2B40:003	Q-Feedforward	0.00	MCTRL	U32	100	P	-
0x2B40:004	D-Feedforward	0.00	MCTRL	U32	100	P	-
0x2B84:001 (P704.01)	DC braking: Current	0.0 %	MCTRL	U16	10	P	-

* Default setting dependent on the model.

Appendix

Parameter attribute list



Address	Name	Default setting	Category	Data type	Factor	A	M
0x2B84:002 (P704.02)	DC braking: Automatic hold time	0.0 s	general	U16	10	P	-
0x2B84:003 (P704.03)	DC braking: Automatic operating threshold	0.0 Hz	general	U16	10	P	-
0x2B84:004 (P704.04)	DC braking: Demagnetization time	100 %	general	U8	1	P	-
0x2B84:005 (P704.05)	DC braking: Default demagnetization time	x ms (Read only)	general	U16	1	-	-
0x2B84:006 (P704.06)	DC braking: Inverter disable	Deactivated [0]	general	U8	1	P	-
0x2BA1:001 (P718.01)	Flying restart circuit: Current	30 %	MCTRL	U16	1	P	-
0x2BA1:002 (P718.02)	Flying restart circuit: Start frequency	20.0 Hz	MCTRL	I16	10	P	-
0x2BA1:003 (P718.03)	Flying restart circuit: Restart time	5911 ms *	MCTRL	U16	1	P	-
0x2BA1:008 (P718.08)	Flying restart circuit: Flying restart frequency	x.x Hz (Read only)	MCTRL	I16	10	O	t
0x2C00 (P300.00)	Motor control mode	V/f characteristic control (VFC open loop) [6]	MCTRL	U8	1	PC	-
0x2C01:001	Motor parameters: Number of pole pairs	- (Read only)	MCTRL	U8	1	-	-
0x2C01:002	Motor parameters: Stator resistance	10.1565 Ω *	MCTRL	U32	10000	P	-
0x2C01:003	Motor parameters: Stator leakage inductance	23.566 mH *	MCTRL	U32	1000	P	-
0x2C01:004 (P320.04)	Motor parameters: Rated speed	Device for 50-Hz mains: 1450 rpm Device for 60-Hz mains: 1750 rpm	MCTRL	U16	1	P	-
0x2C01:005 (P320.05)	Motor parameters: Rated frequency	Device for 50-Hz mains: 50.0 Hz Device for 60-Hz mains: 60.0 Hz	MCTRL	U16	10	P	-
0x2C01:006 (P320.06)	Motor parameters: Rated power	0.25 kW *	MCTRL	U16	100	P	-
0x2C01:007 (P320.07)	Motor parameters: Rated voltage	230 V *	MCTRL	U16	1	P	-
0x2C01:008 (P320.08)	Motor parameters: Cosine phi	0.80	MCTRL	U16	100	P	-
0x2C01:010	Motor parameters: Motor name		MCTRL	STRING[25]	1	P	-
0x2C02:001 (P351.01)	Motor parameter (ASM): Rotor resistance	8.8944 Ω *	MCTRL	U32	10000	P	-
0x2C02:002 (P351.02)	Motor parameter (ASM): Mutual inductance	381.9 mH *	MCTRL	U32	10	P	-
0x2C02:003 (P351.03)	Motor parameter (ASM): Magnetising current	0.96 A *	MCTRL	U16	100	P	-
0x2C02:004 (P351.04)	Motor parameter (ASM): Slip frequency	x.x Hz (Read only)	MCTRL	U16	10	O	-
0x2C03:001 (P352.01)	Motor parameter (PSM): Back EMF constant	41.8 V/1000rpm	MCTRL	U32	10	P	-
0x2C03:005 (P352.05)	Motor parameter (PSM): D-axis inductance Ld	20.000 mH *	MCTRL	U32	1000	P	-
0x2C03:006 (P352.06)	Motor parameter (PSM): Q-axis inductance Lq	20.000 mH *	MCTRL	U32	1000	P	-
0x2C10:001	HF amplitude	50.0 V	MCTRL	U16	10	P	-
0x2C10:008	HF injection range	6.0 %	MCTRL	U16	10	P	-
0x2C11:001	High speed range: Lower limit	10 %	MCTRL	U16	1	P	-
0x2C11:002	High speed range: Tracking controller gain	200 %	MCTRL	U16	1	P	-
0x2C11:003	High speed range: Tracking controller reset time	6.00 ms	MCTRL	U16	100	P	-
0x2C11:004	High speed range: Tracking controller decouple time	200.0 ms	MCTRL	U16	10	P	-
0x2C11:006	High speed range: Stall monitoring limit	50 %	MCTRL	U16	1	P	-

* Default setting dependent on the model.

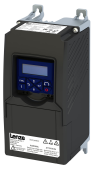

Appendix

Parameter attribute list

Address	Name	Default setting	Category	Data type	Factor	A	M
0x2C12:001	SM low speed range: Acceleration current	70 %	MCTRL	U16	1	P	-
0x2C12:002	SM low speed range: Standstill current	30 %	MCTRL	U16	1	P	-
0x2C13	SLSM-PSM low speed method	Carrier based [1]	MCTRL	U8	1	P	-
0x2C49:001 (P711.01)	Position counter: Signal source	Disabled [0]	general	U8	1	P	-
0x2C49:002 (P711.02)	Position counter: Reset mode	Reset by rising edge [0]	general	U8	1	P	-
0x2C49:003 (P711.03)	Position counter: Actual position	- (Read only)	general	U32	1	OH	t
0x2C60	PPI monitoring: Reaction	Fault [3]	general	U8	1	P	-
0x2C63:001	PPI without movement: Execution	After each enable [2]	MCTRL	U8	1	PC	-
0x2D40:002	Device utilisation ixt: Power unit warning threshold	95 %	general	U16	1	P	-
0x2D40:004 (P135.04)	Device utilisation ixt: Device actual utilisation	x % (Read only)	general	U16	1	O	t
0x2D40:005 (P135.05)	Device utilisation ixt: Device utilisation (ixt): Error response	Fault [3]	general	U8	1	P	-
0x2D43:001 (P306.01)	Inverter load characteristic: Duty selection	Heavy Duty [0]	general	U8	1	PC	-
0x2D44:001 (P350.01)	Overspeed monitoring: Threshold	8000 rpm	MCTRL	U16	1	P	-
0x2D44:002 (P350.02)	Overspeed monitoring: Response	Fault [3]	general	U8	1	P	-
0x2D45:001 (P310.01)	Motor phase failure detection: Response - Motor phase 1	No response [0]	general	U8	1	P	-
0x2D45:002 (P310.02)	Motor phase failure detection: Current threshold	5.0 %	MCTRL	U8	10	P	-
0x2D45:003 (P310.03)	Motor phase failure detection: Voltage threshold	10.0 V	MCTRL	U16	10	P	-
0x2D46:001 (P353.01)	Overcurrent monitoring: Threshold	6.8 A *	MCTRL	U16	10	P	-
0x2D46:002 (P353.02)	Overcurrent monitoring: Response	Fault [3]	general	U8	1	P	-
0x2D48:001 (P308.01)	Motor overload monitoring (i ² xt): Maximum utilisation [60 s]	150 %	MCTRL	U16	1	P	-
0x2D48:002 (P308.02)	Motor overload monitoring (i ² xt): Speed compensation	On [0]	MCTRL	U8	1	P	-
0x2D48:003 (P308.03)	Motor overload monitoring (i ² xt): Response	Fault [3]	general	U8	1	P	-
0x2D48:005	Motor overload monitoring (i ² xt): Thermal load	- (Read only)	general	U16	1	O	-
0x2D4F (P123.00)	Motor utilisation (i ² xt)	x % (Read only)	MCTRL	U16	1	O	t
0x2D66:001 (P721.01)	Mains failure control: Enable function	Disabled [0]	general	U8	1	P	-
0x2D66:002 (P721.02)	Mains failure control: DC-bus activation level	0 % *	general	U8	1	P	-
0x2D66:003 (P721.03)	Mains failure control: Gain V-controller	0.01000 Hz/V	general	U16	100000	P	-
0x2D66:004 (P721.04)	Mains failure control: Reset time V-controller	20 ms	general	U16	1	P	-
0x2D66:005 (P721.05)	Mains failure control: DC voltage setpoint	100 %	general	U8	1	P	-
0x2D66:006 (P721.06)	Mains failure control: Setpoint ramp	20 ms	general	U16	1	P	-
0x2D66:007 (P721.07)	Mains failure control: Clear time	20 ms	general	U16	1	P	-
0x2D66:008 (P721.08)	Mains failure control: Restart threshold	0.0 Hz	general	U16	10	P	-
0x2D66:009 (P721.09)	Mains failure control: Status mains failure control	- (Read only)	general	U8	1	O	t

* Default setting dependent on the model.

Appendix

Parameter attribute list



Address	Name	Default setting	Category	Data type	Factor	A	M
0x2D67:001 (P329.01)	Maximum torque monitoring: Response	No response [0]	MCTRL	U8	1	P	-
0x2D67:002 (P329.02)	Maximum torque monitoring: Triggering delay	0.000 s	MCTRL	U16	1000	P	-
0x2D81:001 (P151.01)	Life-diagnosis: Operating time	x s (Read only)	general	U32	1	T	-
0x2D81:002 (P151.02)	Life-diagnosis: Power-on time	x s (Read only)	general	U32	1	T	-
0x2D81:003 (P151.03)	Life-diagnosis: Control unit operating time	x ns (Read only)	general	U64	1	T	-
0x2D81:004 (P151.04)	Life-diagnosis: Main switching cycles	- (Read only)	general	U32	1	O	-
0x2D81:005 (P151.05)	Life-diagnosis: Relay switching cycles	- (Read only)	general	U32	1	O	-
0x2D81:006 (P151.06)	Life-diagnosis: Short-circuit counter	- (Read only)	general	U16	1	O	-
0x2D81:007 (P151.07)	Life-diagnosis: Earth fault counter	- (Read only)	general	U16	1	O	-
0x2D81:008 (P151.08)	Life-diagnosis: Clamp active	- (Read only)	general	U16	1	O	-
0x2D81:009 (P151.09)	Life-diagnosis: Fan operating time	x s (Read only)	general	U32	1	OT	-
0x2D84:001 (P117.01)	Heatsink temperature: Heatsink temperature	x.x °C (Read only)	general	I16	10	O	t
0x2D84:002	Heatsink temperature: Warning threshold	80.0 °C *	general	I16	10	P	-
0x2D87 (P105.00)	DC-bus voltage	x V (Read only)	general	U16	1	O	t
0x2D88 (P104.00)	Motor current	x.x A (Read only)	general	I16	10	O	t
0x2D89 (P106.00)	Motor voltage	x VAC (Read only)	general	U16	1	O	t
0x2DA2:001 (P108.01)	Output power: Effective power	x.xxx kW (Read only)	general	I32	1000	O	t
0x2DA2:002 (P108.02)	Output power: Apparent power	x.xxx kVA (Read only)	general	I32	1000	O	t
0x2DA3:001 (P109.01)	Output energy: Motor	x.xx kWh (Read only)	general	I32	100	O	t
0x2DA3:002 (P109.02)	Output energy: Generator	x.xx kWh (Read only)	general	I32	100	O	t
0x2DA4:001 (P110.01)	Diagnostics of analog input 1: Value in percent	x.x % (Read only)	general	I16	10	O	t
0x2DA4:002 (P110.02)	Diagnostics of analog input 1: Frequency value	x.x Hz (Read only)	general	I16	10	O	t
0x2DA4:003 (P110.03)	Diagnostics of analog input 1: Process controller value	x.xx PID unit (Read only)	general	I16	100	O	t
0x2DA4:004 (P110.04)	Diagnostics of analog input 1: Torque value	x.x % (Read only)	general	I16	10	O	t
0x2DA4:016 (P110.16)	Diagnostics of analog input 1: Status	- (Read only)	general	U16	1	O	-
0x2DA5:001 (P111.01)	Diagnostics of analog input 2: Value in percent	x.x % (Read only)	general	I16	10	O	t
0x2DA5:002 (P111.02)	Diagnostics of analog input 2: Frequency value	x.x Hz (Read only)	general	I16	10	O	t
0x2DA5:003 (P111.03)	Diagnostics of analog input 2: Process controller value	x.xx PID unit (Read only)	general	I16	100	O	t
0x2DA5:004 (P111.04)	Diagnostics of analog input 2: Torque value	x.x % (Read only)	general	I16	10	O	t
0x2DA5:016 (P111.16)	Diagnostics of analog input 2: Status	- (Read only)	general	U16	1	O	-

* Default setting dependent on the model.

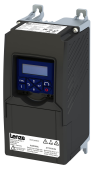

Appendix

Parameter attribute list

Address	Name	Default setting	Category	Data type	Factor	A	M
0x2DAA:001 (P112.01)	Diagnostics of analog output 1: Voltage	x.xx V (Read only)	general	U16	100	O	t
0x2DAA:002 (P112.02)	Diagnostics of analog output 1: Current	x.xx mA (Read only)	general	U16	100	O	t
0x2DAC (P119.00)	Keypad status	- (Read only)	general	U16	1	O	t
0x2DAD (P120.00)	Internal hardware states	- (Read only)	general	U16	1	O	-
0x2DAE:001 (P140.01)	Sequencer diagnostics: Active step	- (Read only)	Sequencer	U8	1	O	t
0x2DAE:002 (P140.02)	Sequencer diagnostics: Step time elapsed	x.x s (Read only)	Sequencer	I32	10	O	t
0x2DAE:003 (P140.03)	Sequencer diagnostics: Step time remaining	x.x s (Read only)	Sequencer	I32	10	O	t
0x2DAE:004 (P140.04)	Sequencer diagnostics: Steps complete	- (Read only)	Sequencer	I32	1	O	t
0x2DAE:005 (P140.05)	Sequencer diagnostics: Steps remaining	- (Read only)	Sequencer	I32	1	O	t
0x2DAE:006 (P140.06)	Sequencer diagnostics: Active sequence	- (Read only)	Sequencer	U8	1	O	t
0x2DAE:007 (P140.07)	Sequencer diagnostics: Active segment	- (Read only)	Sequencer	U8	1	O	t
0x2DAE:008 (P140.08)	Sequencer diagnostics: Relative sequence time remaining	x % (Read only)	Sequencer	U8	1	O	t
0x2DAE:009 (P140.09)	Sequencer diagnostics: Absolute sequence time remaining	x.x s (Read only)	Sequencer	I32	10	O	t
0x2DAE:010	Sequencer diagnostics: Frequency setpoint	x.x Hz (Read only)	Sequencer	I16	10	-	-
0x2DAE:011	Sequencer diagnostics: PID setpoint	x.xx PID unit (Read only)	Sequencer	I16	100	-	-
0x2DAE:012	Sequencer diagnostics: Torque setpoint	x.x % (Read only)	Sequencer	I16	10	-	-
0x2DD1:001	Motor currents: Actual D-current (id)	x.xx A (Read only)	MCTRL	I32	100	O	t
0x2DD1:002	Motor currents: Actual Q-current (iq)	x.xx A (Read only)	general	I32	100	O	t
0x2DD1:003	Motor currents: Setpoint D-current (id)	x.xx A (Read only)	general	I32	100	O	t
0x2DD1:004	Motor currents: Setpoint Q-current (iq)	x.xx A (Read only)	MCTRL	I32	100	O	t
0x2DD1:005	Motor currents: Motor current (I _{eff})	x.xx A (Read only)	MCTRL	I32	100	O	t
0x2DD3:003	Speed setpoint limited	x rpm (Read only)	MCTRL	I32	1	O	t
0x2DD5	Torque setpoint	x.xx Nm (Read only)	general	I32	100	-	t
0x2DDD (P100.00)	Output frequency	x.x Hz (Read only)	general	I16	10	O	t
0x2DDF:001	Axis information: Rated current	x.xx A (Read only)	MCTRL	U16	100	O	t
0x2DDF:002	Axis information: Maximum current	x.xx A (Read only)	MCTRL	U16	100	O	t
0x2DE0:010	Motor control behavior	0	general	U16	1	PC	-
0x4002 (P702.00)	Speed display scaling	0.00	general	U16	100	P	-
0x4003 (P413.00)	MOP starting mode	Last value [0]	general	U8	1	P	-
0x4004:001 (P414.01)	MOP starting values: Frequency	0.0 Hz	general	U16	10	P	-
0x4004:002 (P414.02)	MOP starting values: PID value	0.00 PID unit	general	I16	100	P	-
0x4004:003 (P414.03)	MOP starting values: Torque	0.0 %	general	U16	10	P	-
0x4005 (P412.00)	Frequency threshold	0.0 Hz	general	U16	10	P	-
0x4006:001 (P710.01)	Load loss detection: Threshold	0.0 %	general	U16	10	P	-
0x4006:002 (P710.02)	Load loss detection: Delay time	0.0 s	general	U16	10	P	-

* Default setting dependent on the model.

Appendix

Parameter attribute list



Address	Name	Default setting	Category	Data type	Factor	A	M
0x4006:003 (P710.03)	Load loss detection: Error response	No response [0]	general	U8	1	P	-
0x4007:001	Heavy load monitoring: Error threshold	200.0 %	general	U16	10	P	-
0x4007:002	Heavy load monitoring: Delay time	3.0 s	general	U16	10	P	-
0x4007:003	Heavy load monitoring: Error response	No response [0]	general	U8	1	P	-
0x4008:001 (P590.01)	Process input words: NetWordIN1	0x0000	general	U16	1	HK	r
0x4008:002 (P590.02)	Process input words: NetWordIN2	0x0000	general	U16	1	HK	r
0x4008:003 (P590.03)	Process input words: NetWordIN3	0.0 %	general	U16	10	K	r
0x4008:004 (P590.04)	Process input words: NetWordIN4	0.0 %	general	U16	10	K	r
0x4008:005 (P590.05)	Process input words: NetWordIN5	0.0 %	general	I16	10	K	r
0x4009:001	MOP values saved: Frequency	x.x Hz (Read only)	general	U16	10	-	t
0x4009:002	MOP values saved: PID value	x.xx PID unit (Read only)	general	I16	100	-	t
0x4009:003	MOP values saved: Torque	x.x % (Read only)	general	U16	10	-	t
0x400A:001 (P591.01)	Process output words: NetWordOUT1	- (Read only)	general	U16	1	OH	t
0x400A:002 (P591.02)	Process output words: NetWordOUT2	- (Read only)	general	U16	1	O	t
0x400B:001 (P592.01)	Process input data: AC Drive control word	0x0000	general	U16	1	HK	r
0x400B:002 (P592.02)	Process input data: LECOM control word	0x0000	general	U16	1	HK	r
0x400B:003 (P592.03)	Process input data: Network setpoint frequency (0.1)	0.0 Hz	general	U16	10	K	r
0x400B:004 (P592.04)	Process input data: Network setpoint speed	0 rpm	general	U16	1	K	r
0x400B:005 (P592.05)	Process input data: Network setpoint frequency (0.01)	0.00 Hz	general	U16	100	K	r
0x400B:006 (P592.06)	Process input data: Velocity mode setpoint	0.0 Hz	general	I16	10	K	r
0x400B:007 (P592.07)	Process input data: PID setpoint	0.00 PID unit	general	I16	100	K	r
0x400B:008 (P592.08)	Process input data: Torque mode setpoint	0 Nm	general	I16	1	K	r
0x400B:009 (P592.09)	Process input data: Torque scaling	0	general	I8	1	K	r
0x400B:011 (P592.11)	Process input data: PID feedback	0.00 PID unit	general	I16	100	K	r
0x400B:012 (P592.12)	Process input data: Network setpoint frequency [0.02Hz]	0 Hz	general	I16	50	K	r
0x400B:013 (P592.13)	Process input data: Network frequency setpoint [+/-16384]	0	general	I16	1	-	r
0x400C:001 (P593.01)	Process output data: AC Drive status word	- (Read only)	general	U16	1	-	t
0x400C:002 (P593.02)	Process output data: LECOM status word	- (Read only)	general	U16	1	-	t
0x400C:003 (P593.03)	Process output data: Frequency (0.1)	x.x Hz (Read only)	general	U16	10	-	t
0x400C:004 (P593.04)	Process output data: Motor speed	x rpm (Read only)	general	U16	1	-	t
0x400C:005 (P593.05)	Process output data: Drive status	- (Read only)	general	U16	1	-	t
0x400C:006 (P593.06)	Process output data: Frequency (0.01)	x.xx Hz (Read only)	general	U16	100	-	t

* Default setting dependent on the model.

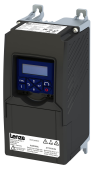

Appendix

Parameter attribute list

Address	Name	Default setting	Category	Data type	Factor	A	M
0x400C:007 (P593.07)	Process output data: Torque scaled	- (Read only)	general	I16	1	-	t
0x400C:008 (P593.08)	Process output data: Frequency [0.02 Hz]	Hz (Read only)	general	I16	50	-	t
0x400C:009 (P593.09)	Process output data: Frequency [+/-16384]	- (Read only)	general	I16	1	-	t
0x400D (P101.00)	Scaled actual value	x Units (Read only)	general	I16	1	O	t
0x400E:001 (P505.01)	NetWordIN1 function: Bit 0	Not active [0]	general	U8	1	PC	-
0x400E:002 (P505.02)	NetWordIN1 function: Bit 1	Not active [0]	general	U8	1	PC	-
0x400E:003 (P505.03)	NetWordIN1 function: Bit 2	Activate quick stop [3]	general	U8	1	PC	-
0x400E:004 (P505.04)	NetWordIN1 function: Bit 3	Not active [0]	general	U8	1	PC	-
0x400E:005 (P505.05)	NetWordIN1 function: Bit 4	Run forward (CW) [8]	general	U8	1	PC	-
0x400E:006 (P505.06)	NetWordIN1 function: Bit 5	Activate preset (bit 0) [18]	general	U8	1	PC	-
0x400E:007 (P505.07)	NetWordIN1 function: Bit 6	Activate preset (bit 1) [19]	general	U8	1	PC	-
0x400E:008 (P505.08)	NetWordIN1 function: Bit 7	Reset error [4]	general	U8	1	PC	-
0x400E:009 (P505.09)	NetWordIN1 function: Bit 8	Not active [0]	general	U8	1	PC	-
0x400E:010 (P505.10)	NetWordIN1 function: Bit 9	Activate DC braking [5]	general	U8	1	PC	-
0x400E:011 (P505.11)	NetWordIN1 function: Bit 10	Not active [0]	general	U8	1	PC	-
0x400E:012 (P505.12)	NetWordIN1 function: Bit 11	Not active [0]	general	U8	1	PC	-
0x400E:013 (P505.13)	NetWordIN1 function: Bit 12	Reverse rotational direction [13]	general	U8	1	PC	-
0x400E:014 (P505.14)	NetWordIN1 function: Bit 13	Not active [0]	general	U8	1	PC	-
0x400E:015 (P505.15)	NetWordIN1 function: Bit 14	Not active [0]	general	U8	1	PC	-
0x400E:016 (P505.16)	NetWordIN1 function: Bit 15	Not active [0]	general	U8	1	PC	-
0x4016:003	Digital output 1: Cutout delay	0.000 s	general	U16	1000	P	-
0x4016:004	Digital output 1: Switch-on delay	0.000 s	general	U16	1000	P	-
0x4016:005	Digital output 1: Terminal state	- (Read only)	general	U8	1	O	-
0x4016:006	Digital output 1: Trigger signal state	- (Read only)	general	U8	1	O	-
0x4018:003	Relay: Switch-off delay	0.000 s	general	U16	1000	P	-
0x4018:004	Relay: Switch-on delay	0.000 s	general	U16	1000	P	-
0x4018:005	Relay: Relay state	- (Read only)	general	U8	1	O	-
0x4018:006	Relay: Trigger signal state	- (Read only)	general	U8	1	O	-
0x4018:007	Relay: Switching cycles	- (Read only)	general	U32	1	O	-
0x401F:001 (P121.01)	Process controller diagnostics: Current setpoint	x.xx PID unit (Read only)	general	I16	100	O	t
0x401F:002 (P121.02)	Process controller diagnostics: Current process variable	x.xx PID unit (Read only)	general	I16	100	O	t
0x401F:003 (P121.03)	Process controller diagnostics: Status	- (Read only)	general	U8	1	O	t
0x401F:004	Process controller diagnostics: PID control value	x.x Hz (Read only)	general	I16	10	O	-
0x401F:005	Process controller diagnostics: PID Feedforward value	x.x Hz (Read only)	general	I16	10	O	-

* Default setting dependent on the model.

Appendix

Parameter attribute list



Address	Name	Default setting	Category	Data type	Factor	A	M
0x401F:006	Process controller diagnostics: PID output value	x.x Hz (Read only)	general	I16	10	O	t
0x401F:007	Process controller diagnostics: PID error value	x.xx PID unit (Read only)	general	I32	100	O	-
0x4020:001 (P600.01)	Process controller setup (PID): Operating mode	Inhibited [0]	general	U8	1	P	-
0x4020:002 (P600.02)	Process controller setup (PID): PID process variable	Analog input 1 [1]	general	U8	1	P	-
0x4020:003 (P600.03)	Process controller setup (PID): Closed-loop controlled speed range	100 %	general	U16	1	P	rt
0x4020:004 (P600.04)	Process controller setup (PID): Speed feedforward control source	Without speed addition [0]	general	U8	1	P	-
0x4020:005 (P600.05)	Process controller setup (PID): Min speed limit	-100.0 %	general	I16	10	P	-
0x4020:006 (P600.06)	Process controller setup (PID): Max speed limit	100.0 %	general	I16	10	P	-
0x4021:001 (P606.01)	PID speed operation: Acceleration time	1.0 s	general	U16	10	P	-
0x4021:002 (P606.02)	PID speed operation: Deceleration time	1.0 s	general	U16	10	P	-
0x4022:001 (P451.01)	PID setpoint presets: Preset 1	0.00 PID unit	general	I16	100	OP	-
0x4022:002 (P451.02)	PID setpoint presets: Preset 2	0.00 PID unit	general	I16	100	OP	-
0x4022:003 (P451.03)	PID setpoint presets: Preset 3	0.00 PID unit	general	I16	100	OP	-
0x4022:004 (P451.04)	PID setpoint presets: Preset 4	0.00 PID unit	general	I16	100	OP	-
0x4022:005 (P451.05)	PID setpoint presets: Preset 5	0.00 PID unit	general	I16	100	OP	-
0x4022:006 (P451.06)	PID setpoint presets: Preset 6	0.00 PID unit	general	I16	100	OP	-
0x4022:007 (P451.07)	PID setpoint presets: Preset 7	0.00 PID unit	general	I16	100	OP	-
0x4022:008 (P451.08)	PID setpoint presets: Preset 8	0.00 PID unit	general	I16	100	OP	-
0x4023:001 (P610.01)	PID sleep mode: Activation	Disabled [0]	general	U8	1	P	-
0x4023:002 (P610.02)	PID sleep mode: Stop method	Coasting [0]	general	U8	1	P	-
0x4023:003 (P610.03)	PID sleep mode: Frequency threshold	0.0 Hz	general	U16	10	P	-
0x4023:004 (P610.04)	PID sleep mode: Feedback threshold	0.00 PID unit	general	I16	100	P	-
0x4023:005 (P610.05)	PID sleep mode: Delay time	0.0 s	general	U16	10	P	-
0x4023:006 (P610.06)	PID sleep mode: Recovery	Setpoint > threshold OR system deviation > bandwidth [0]	general	U8	1	P	-
0x4023:007 (P610.07)	PID sleep mode: Bandwidth	0.00 PID unit	general	U16	100	P	-
0x4023:008 (P610.08)	PID sleep mode: Recovery threshold	0.00 PID unit	general	I16	100	P	-
0x4024:001 (P615.01)	Automatic rinsing: Rinsing in sleep mode	Inhibited [0]	general	U8	1	P	-
0x4024:002 (P615.02)	Automatic rinsing: Rinse interval	30.0 min	general	U16	10	P	-
0x4024:003 (P615.03)	Automatic rinsing: Rinse speed	0.0 Hz	general	I16	10	P	-
0x4024:004 (P615.04)	Automatic rinsing: Rinse period	0.0 s	general	U16	10	P	-

* Default setting dependent on the model.

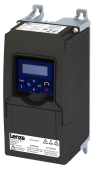

Appendix

Parameter attribute list

Address	Name	Default setting	Category	Data type	Factor	A	M
0x4025 (P800.00)	Sequencer mode	Disabled [0]	Sequencer	U8	1	P	-
0x4026:001 (P801.01)	Sequencer segment 1: Frequency setpoint	0.0 Hz	Sequencer	I16	10	P	-
0x4026:002 (P801.02)	Sequencer segment 1: Acceleration/deceleration	5.0 s	Sequencer	U16	10	P	-
0x4026:003 (P801.03)	Sequencer segment 1: Time	0.0 s	Sequencer	U32	10	P	-
0x4026:004 (P801.04)	Sequencer segment 1: Digital outputs	0	Sequencer	U8	1	P	-
0x4026:005 (P801.05)	Sequencer segment 1: Analog outputs	0.00 VDC	Sequencer	U16	100	P	-
0x4026:006 (P801.06)	Sequencer segment 1: PID setpoint	0.00 PID unit	Sequencer	I16	100	P	-
0x4026:007 (P801.07)	Sequencer segment 1: Torque setpoint	100.0 %	Sequencer	I16	10	P	-
0x4026:008	Sequencer segment 1: NetWordOUT2	0	Sequencer	U16	1	P	-
0x4026:009	Sequencer segment 1: Reserved	0	Sequencer	U32	1	P	-
0x4027:001 (P802.01)	Sequencer segment 2: Frequency setpoint	0.0 Hz	Sequencer	I16	10	P	-
0x4027:002 (P802.02)	Sequencer segment 2: Acceleration/deceleration	5.0 s	Sequencer	U16	10	P	-
0x4027:003 (P802.03)	Sequencer segment 2: Time	0.0 s	Sequencer	U32	10	P	-
0x4027:004 (P802.04)	Sequencer segment 2: Digital outputs	0	Sequencer	U8	1	P	-
0x4027:005 (P802.05)	Sequencer segment 2: Analog outputs	0.00 VDC	Sequencer	U16	100	P	-
0x4027:006 (P802.06)	Sequencer segment 2: PID setpoint	0.00 PID unit	Sequencer	I16	100	P	-
0x4027:007 (P802.07)	Sequencer segment 2: Torque setpoint	100.0 %	Sequencer	I16	10	P	-
0x4027:008	Sequencer segment 2: NetWordOUT2	0	Sequencer	U16	1	P	-
0x4027:009	Sequencer segment 2: Reserved	0	Sequencer	U32	1	P	-
0x4028:001 (P803.01)	Sequencer segment 3: Frequency setpoint	0.0 Hz	Sequencer	I16	10	P	-
0x4028:002 (P803.02)	Sequencer segment 3: Acceleration/deceleration	5.0 s	Sequencer	U16	10	P	-
0x4028:003 (P803.03)	Sequencer segment 3: Time	0.0 s	Sequencer	U32	10	P	-
0x4028:004 (P803.04)	Sequencer segment 3: Digital outputs	0	Sequencer	U8	1	P	-
0x4028:005 (P803.05)	Sequencer segment 3: Analog outputs	0.00 VDC	Sequencer	U16	100	P	-
0x4028:006 (P803.06)	Sequencer segment 3: PID setpoint	0.00 PID unit	Sequencer	I16	100	P	-
0x4028:007 (P803.07)	Sequencer segment 3: Torque setpoint	100.0 %	Sequencer	I16	10	P	-
0x4028:008	Sequencer segment 3: NetWordOUT2	0	Sequencer	U16	1	P	-
0x4028:009	Sequencer segment 3: Reserved	0	Sequencer	U32	1	P	-
0x4029:001 (P804.01)	Sequencer segment 4: Frequency setpoint	0.0 Hz	Sequencer	I16	10	P	-
0x4029:002 (P804.02)	Sequencer segment 4: Acceleration/deceleration	5.0 s	Sequencer	U16	10	P	-
0x4029:003 (P804.03)	Sequencer segment 4: Time	0.0 s	Sequencer	U32	10	P	-
0x4029:004 (P804.04)	Sequencer segment 4: Digital outputs	0	Sequencer	U8	1	P	-

* Default setting dependent on the model.

Appendix

Parameter attribute list



Address	Name	Default setting	Category	Data type	Factor	A	M
0x4029:005 (P804.05)	Sequencer segment 4: Analog outputs	0.00 VDC	Sequencer	U16	100	P	-
0x4029:006 (P804.06)	Sequencer segment 4: PID setpoint	0.00 PID unit	Sequencer	I16	100	P	-
0x4029:007 (P804.07)	Sequencer segment 4: Torque setpoint	100.0 %	Sequencer	I16	10	P	-
0x4029:008	Sequencer segment 4: NetWordOUT2	0	Sequencer	U16	1	P	-
0x4029:009	Sequencer segment 4: Reserved	0	Sequencer	U32	1	P	-
0x402A:001 (P805.01)	Sequencer segment 5: Frequency setpoint	0.0 Hz	Sequencer	I16	10	P	-
0x402A:002 (P805.02)	Sequencer segment 5: Acceleration/deceleration	5.0 s	Sequencer	U16	10	P	-
0x402A:003 (P805.03)	Sequencer segment 5: Time	0.0 s	Sequencer	U32	10	P	-
0x402A:004 (P805.04)	Sequencer segment 5: Digital outputs	0	Sequencer	U8	1	P	-
0x402A:005 (P805.05)	Sequencer segment 5: Analog outputs	0.00 VDC	Sequencer	U16	100	P	-
0x402A:006 (P805.06)	Sequencer segment 5: PID setpoint	0.00 PID unit	Sequencer	I16	100	P	-
0x402A:007 (P805.07)	Sequencer segment 5: Torque setpoint	100.0 %	Sequencer	I16	10	P	-
0x402A:008	Sequencer segment 5: NetWordOUT2	0	Sequencer	U16	1	P	-
0x402A:009	Sequencer segment 5: Reserved	0	Sequencer	U32	1	P	-
0x402B:001 (P806.01)	Sequencer segment 6: Frequency setpoint	0.0 Hz	Sequencer	I16	10	P	-
0x402B:002 (P806.02)	Sequencer segment 6: Acceleration/deceleration	5.0 s	Sequencer	U16	10	P	-
0x402B:003 (P806.03)	Sequencer segment 6: Time	0.0 s	Sequencer	U32	10	P	-
0x402B:004 (P806.04)	Sequencer segment 6: Digital outputs	0	Sequencer	U8	1	P	-
0x402B:005 (P806.05)	Sequencer segment 6: Analog outputs	0.00 VDC	Sequencer	U16	100	P	-
0x402B:006 (P806.06)	Sequencer segment 6: PID setpoint	0.00 PID unit	Sequencer	I16	100	P	-
0x402B:007 (P806.07)	Sequencer segment 6: Torque setpoint	100.0 %	Sequencer	I16	10	P	-
0x402B:008	Sequencer segment 6: NetWordOUT2	0	Sequencer	U16	1	P	-
0x402B:009	Sequencer segment 6: Reserved	0	Sequencer	U32	1	P	-
0x402C:001 (P807.01)	Sequencer segment 7: Frequency setpoint	0.0 Hz	Sequencer	I16	10	P	-
0x402C:002 (P807.02)	Sequencer segment 7: Acceleration/deceleration	5.0 s	Sequencer	U16	10	P	-
0x402C:003 (P807.03)	Sequencer segment 7: Time	0.0 s	Sequencer	U32	10	P	-
0x402C:004 (P807.04)	Sequencer segment 7: Digital outputs	0	Sequencer	U8	1	P	-
0x402C:005 (P807.05)	Sequencer segment 7: Analog outputs	0.00 VDC	Sequencer	U16	100	P	-
0x402C:006 (P807.06)	Sequencer segment 7: PID setpoint	0.00 PID unit	Sequencer	I16	100	P	-
0x402C:007 (P807.07)	Sequencer segment 7: Torque setpoint	100.0 %	Sequencer	I16	10	P	-
0x402C:008	Sequencer segment 7: NetWordOUT2	0	Sequencer	U16	1	P	-
0x402C:009	Sequencer segment 7: Reserved	0	Sequencer	U32	1	P	-
0x402D:001 (P808.01)	Sequencer segment 8: Frequency setpoint	0.0 Hz	Sequencer	I16	10	P	-

* Default setting dependent on the model.

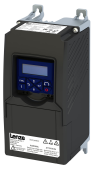

Appendix

Parameter attribute list

Address	Name	Default setting	Category	Data type	Factor	A	M
0x402D:002 (P808.02)	Sequencer segment 8: Acceleration/deceleration	5.0 s	Sequencer	U16	10	P	-
0x402D:003 (P808.03)	Sequencer segment 8: Time	0.0 s	Sequencer	U32	10	P	-
0x402D:004 (P808.04)	Sequencer segment 8: Digital outputs	0	Sequencer	U8	1	P	-
0x402D:005 (P808.05)	Sequencer segment 8: Analog outputs	0.00 VDC	Sequencer	U16	100	P	-
0x402D:006 (P808.06)	Sequencer segment 8: PID setpoint	0.00 PID unit	Sequencer	I16	100	P	-
0x402D:007 (P808.07)	Sequencer segment 8: Torque setpoint	100.0 %	Sequencer	I16	10	P	-
0x402D:008	Sequencer segment 8: NetWordOUT2	0	Sequencer	U16	1	P	-
0x402D:009	Sequencer segment 8: Reserved	0	Sequencer	U32	1	P	-
0x402E:001 (P822.01)	End segment: Frequency setpoint	0.0 Hz	Sequencer	I16	10	P	-
0x402E:002 (P822.02)	End segment: Acceleration/deceleration	5.0 s	Sequencer	U16	10	P	-
0x402E:003 (P822.03)	End segment: Time	0.0 s	Sequencer	U32	10	P	-
0x402E:004 (P822.04)	End segment: Digital outputs	0	Sequencer	U8	1	P	-
0x402E:005 (P822.05)	End segment: Analog outputs	0.00 VDC	Sequencer	U16	100	P	-
0x402E:006 (P822.06)	End segment: PID setpoint	0.00 PID unit	Sequencer	I16	100	P	-
0x402E:007 (P822.07)	End segment: Torque setpoint	100.0 %	Sequencer	I16	10	P	-
0x402E:008	End segment: NetWordOUT2	0	Sequencer	U16	1	P	-
0x402E:009	End segment: Reserved	0	Sequencer	U32	1	P	-
0x402F (P824.00)	End of sequence mode	Keep running [0]	Sequencer	U8	1	P	-
0x4030:001 ... 0x4030:016 (P830.01 ... 16)	Sequence 1: Step 1 ... Step 16	Skip step [0]	Sequencer	I8	1	P	-
0x4031 (P831.00)	Number of cycles sequence 1	1	Sequencer	U16	1	P	-
0x4032:001 ... 0x4032:016 (P835.01 ... 16)	Sequence 2: Step 1 ... Step 16	Skip step [0]	Sequencer	I8	1	P	-
0x4033 (P836.00)	Number of cycles sequence 2	1	Sequencer	U16	1	P	-
0x4034:001 ... 0x4034:016 (P840.01 ... 16)	Sequence 3: Step 1 ... Step 16	Skip step [0]	Sequencer	I8	1	P	-
0x4035 (P841.00)	Number of cycles sequence 3	1	Sequencer	U16	1	P	-
0x4036:001 ... 0x4036:016 (P845.01 ... 16)	Sequence 4: Step 1 ... Step 16	Skip step [0]	Sequencer	I8	1	P	-
0x4037 (P846.00)	Number of cycles sequence 4	1	Sequencer	U16	1	P	-
0x4038:001 ... 0x4038:016 (P850.01 ... 16)	Sequence 5: Step 1 ... Step 16	Skip step [0]	Sequencer	I8	1	P	-
0x4039 (P851.00)	Number of cycles sequence 5	1	Sequencer	U16	1	P	-

* Default setting dependent on the model.

Appendix

Parameter attribute list



Address	Name	Default setting	Category	Data type	Factor	A	M
0x403A:001 ... 0x403A:016 (P855.01 ... 16)	Sequence 6: Step 1 ... Step 16	Skip step [0]	Sequencer	I8	1	P	-
0x403B (P856.00)	Number of cycles sequence 6	1	Sequencer	U16	1	P	-
0x403C:001 ... 0x403C:016 (P860.01 ... 16)	Sequence 7: Step 1 ... Step 16	Skip step [0]	Sequencer	I8	1	P	-
0x403D (P861.00)	Number of cycles sequence 7	1	Sequencer	U16	1	P	-
0x403E:001 ... 0x403E:016 (P865.01 ... 16)	Sequence 8: Step 1 ... Step 16	Skip step [0]	Sequencer	I8	1	P	-
0x403F (P866.00)	Number of cycles sequence 8	1	Sequencer	U16	1	P	-
0x4040 (P820.00)	Start of sequence mode	Restart sequencer [0]	Sequencer	U8	1	P	-
0x4041:001 ... 0x4041:032 (P750.01 ... 32)	Parameter change-over: Parameter 1 ... Parameter 32	0x00000000	general	IDX	1	PH	-
0x4042:001 ... 0x4042:032 (P751.01 ... 32)	Parameter value set 1: Value of parameter 1 ... Value of parameter 32	0	general	I32	1	P	-
0x4043:001 ... 0x4043:032 (P752.01 ... 32)	Parameter value set 2: Value of parameter 1 ... Value of parameter 32	0	general	I32	1	P	-
0x4044:001 ... 0x4044:032 (P753.01 ... 32)	Parameter value set 3: Value of parameter 1 ... Value of parameter 32	0	general	I32	1	P	-
0x4045:001 ... 0x4045:032 (P754.01 ... 32)	Parameter value set 4: Value of parameter 1 ... Value of parameter 32	0	general	I32	1	P	-
0x4046 (P755.00)	Activation of parameter set	Via command (disable required) [0]	general	U8	1	P	-
0x4047:001 (P756.01)	Parameter change-over error message: Status	- (Read only)	general	U16	1	O	-
0x4047:002 (P756.02)	Parameter change-over error message: List entry	- (Read only)	general	U8	1	O	-
0x4048 (P601.00)	PID P-component	5.0 %	general	U16	10	P	rt
0x4049 (P602.00)	PID I- component	400 ms	general	U16	1	P	rt
0x404A (P603.00)	PID D-component	0.0 s	general	U8	10	P	rt
0x404B (P604.00)	PID setpoint ramp	20.0 s	general	U16	10	P	-
0x404C:001 (P607.01)	PID influence: Acceleration time for activation	5.0 s	general	U16	10	P	-
0x404C:002 (P607.02)	PID influence: Deceleration time for masking out	5.0 s	general	U16	10	P	-
0x404D:001 (P608.01)	PID alarms: MIN alarm threshold	0.00 PID unit	general	I16	100	P	-
0x404D:002 (P608.02)	PID alarms: MAX alarm threshold	100.00 PID unit	general	I16	100	P	-
0x404D:003 (P608.03)	PID alarms: Monitoring bandwidth PID feedback signal	2.00 %	general	U16	100	P	-
0x404E:001 (P605.01)	PID setpoint limits: Minimum setpoint	-300.00 PID unit	general	I16	100	P	-
0x404E:002 (P605.02)	PID setpoint limits: Maximum setpoint	300.00 PID unit	general	I16	100	P	-

* Default setting dependent on the model.

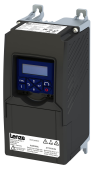

Appendix

Parameter attribute list

Address	Name	Default setting	Category	Data type	Factor	A	M
0x405C:001 (P770.01)	Pump cascading: Operating mode	Disabled [0]		U8	1	P	-
0x405C:002 (P770.02)	Pump cascading: Priority at startup	By operating time [1]		U8	1	P	-
0x405C:003 (P770.03)	Pump cascading: Start frequency	40.0 Hz		U16	10	P	-
0x405C:004 (P770.04)	Pump cascading: Stop frequency	10.0 Hz		U16	10	P	-
0x405C:005 (P770.05)	Pump cascading: Settling time	5.0 s		U16	10	P	-
0x405C:006 (P770.06)	Pump cascading: Delay time	2.0 s		U16	10	P	-
0x405C:007 (P770.07)	Pump cascading: Lower frequency threshold	20.0 Hz		U16	10	P	-
0x405C:008 (P770.08)	Pump cascading: Upper frequency threshold	30.0 Hz		U16	10	P	-
0x405C:009 (P770.09)	Pump cascading: Automatic runtime	0 h		U16	1	P	-
0x405C:010 (P770.10)	Pump cascading: Automatic transition time	0.0 s		I16	10	P	-
0x405C:011 (P770.11)	Pump cascading: Reset operating time	Disabled [0]		U8	1	P	-
0x405C:012 (P770.12)	Pump cascading: Status word	- (Read only)		U16	1	-	-
0x405C:013 (P770.13)	Pump cascading: Operating time pump 1	x s (Read only)		U32	1	T	-
0x405C:014 (P770.14)	Pump cascading: Operating time pump 2	x s (Read only)		U32	1	T	-
0x603F (P150.00)	Error code	- (Read only)	general	U16	1	O	t
0x6040	CiA control word	0	general	U16	1	O	r
0x6041 (P780.00)	CiA status word	- (Read only)	general	U16	1	O	t
0x6042 (P781.00)	Set speed	0 rpm	MCTRL	I16	1	K	r
0x6043 (P782.00)	Internal set speed	x rpm (Read only)	general	I16	1	O	t
0x6044 (P783.00)	Actual speed	x rpm (Read only)	general	I16	1	O	t
0x6046:001 (P784.01)	Speed limits: Min. speed	0 rpm	MCTRL	U32	1	P	r
0x6046:002 (P784.02)	Speed limits: Max. speed	2147483647 rpm	MCTRL	U32	1	P	r
0x6048:001 (P785.01)	Acceleration ramp: CiA acceleration: Delta speed	3000 rpm	MCTRL	U32	1	P	r
0x6048:002 (P785.02)	Acceleration ramp: CiA acceleration: Delta time	10 s	MCTRL	U16	1	P	r
0x6049:001 (P786.01)	Deceleration ramp: CiA deceleration: Delta speed	3000 rpm	MCTRL	U32	1	P	r
0x6049:002 (P786.02)	Deceleration ramp: CiA deceleration: Delta time	10 s	MCTRL	U16	1	P	r
0x605A	CiA: Quick stop mode	Ramp > switch on disabled [2]	general	I16	1	P	-
0x605B	Shutdown option code	Disable drive function [0]	general	I16	1	P	-
0x6060 (P301.00)	CiA: Operation mode	MS: Velocity mode [-2]	MCTRL	I8	1	PC	-
0x6061 (P788.00)	CiA: Active operation mode	- (Read only)	MCTRL	I8	1	O	t
0x6071	Set torque	0.0 %	general	I16	10	K	r

* Default setting dependent on the model.

Appendix

Parameter attribute list



Address	Name	Default setting	Category	Data type	Factor	A	M
0x6072 (P326.00)	Max. torque	250.0 %	MCTRL	U16	10	P	r
0x6073 (P324.00)	Max. current	200.0 %	MCTRL	U16	10	P	r
0x6074	Internal set torque	x.x % (Read only)	MCTRL	I16	10	O	-
0x6075 (P323.00)	Rated motor current	1.700 A *	MCTRL	U32	1000	PC	-
0x6076 (P325.00)	Rated motor torque	1.650 Nm *	MCTRL	U32	1000	PC	-
0x6077 (P107.00)	Actual torque	x.x % (Read only)	general	I16	10	O	t
0x6078 (P103.00)	Actual current	x.x % (Read only)	general	I16	10	O	t
0x6079	DC-bus voltage	x.xxx V (Read only)	general	U32	1000	O	t
0x6080 (P322.00)	Max. motor speed	6075 rpm	MCTRL	U32	1	P	r
0x6085 (P790.00)	Quick stop deceleration	546000 pos. unit/s²	MCTRL	U32	1	P	-
0x60E0	Positive torque limit	250.0 %	MCTRL	U16	10	P	r
0x60E1	Negative torque limit	250.0 %	MCTRL	U16	10	P	r
0x60FD (P118.00)	Digital input status	- (Read only)	general	U32	1	O	t
0x6402	Motor type	Squirrel cage induction [7]	MCTRL	U16	1	P	-
0x6502 (P789.00)	Supported drive modes	- (Read only)	general	U32	1	-	-

* Default setting dependent on the model.

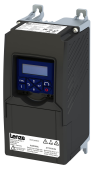

18.2 Glossary

Abbreviation	Meaning
AIE	Acknowledge In Error, error acknowledgement
AIS	Acknowledge In Stop, restart acknowledgement
OFF state	Triggered signal status of the sensors
CCF	Common Cause Error (also β -value)
EC_FS	Error Class Fail Safe
EC_SS1	Error-Class Safe Stop 1
EC_SS2	Error-Class Safe Stop 2
EC_STO	Error-Class Safe Torque Off Stop 0
ON state	Signal status of the safety sensor in normal operation
FIT	Failure In Time, 1 FIT = 10 ⁻⁹ Error/h
FMEA	Failure Mode and Effect Analysis
FSOE	FailSafe over EtherCAT
GSDML	Device description file with PROFINET-specific data to integrate the configuring software of a PROFINET controller.
HFT	Hardware Failure Tolerance
Cat.	Category in accordance with EN ISO 13849-1
OSSD	Output Signal Switching Device, tested signal output
PELV	Protective Extra Low Voltage, extra-low voltage with safe isolation
PL	Performance Level according to EN ISO 13849-1
PM	Plus-Minus – switched signal paths
PP	Plus-Plus – switched signal paths
PS	PROFIsafe
PWM	Pulse width modulation
SCS	Safe crawling speed
SD-In	Safe Digital Input
SD-Out	Safe Digital Output
SELV	Safety Extra Low Voltage
SFF	Safe Failure Fraction
SIL	Safety Integrity Level in accordance with IEC 61508

